

# FUN WITH EASY ORIGAMI

48-page Booklet with 32 Projects and 24 Sheets of Origami Paper



Dover Publications, Inc.

# FUN WITH EASY ORIGAMI

John Montroll

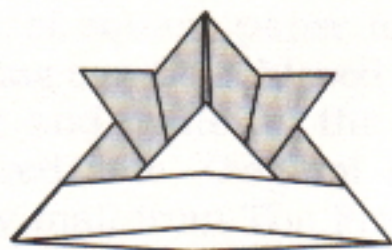

DOVER PUBLICATIONS, INC.

New York

FUN WITH  
EASY ORIGAMI

John Montroll



Copyright © 1992 by John Montroll.  
All rights reserved under Pan American and International Copyright  
Conventions.

Published in Canada by General Publishing Company, Ltd., 30 Lesmill  
Road, Don Mills, Toronto, Ontario.

*Fun with Easy Origami: 32 Projects and 24 Sheets of Origami Paper* is a  
new work, first published by Dover Publications, Inc., in 1993, consisting of  
origami paper and a slightly altered reprint of *Easy Origami* by John  
Montroll, originally published by Dover in 1992.

*International Standard Book Number: 0-486-27480-2*

Manufactured in the United States of America  
Dover Publications, Inc., 31 East 2nd Street, Mineola, N.Y. 11501

# Introduction

I have compiled this collection of traditional Japanese projects for beginners in the hope of sparking a life-long interest in this ancient, elegant art. The models you will fold out of this book, such as a house that turns into a piano, a sailboat, assorted boxes, and other old favorites should provide a good foundation as you move on to more advanced paper folding.

The diagrams are drawn in the internationally approved Randlett-Yoshizawa style, which, you will find, is easy to follow once you have learned the basic folds. You can use any kind of square paper for these models, but the best results and most precise folding can be achieved using standard origami paper, which is colored on one side and white on the other. In these diagrams, the shading represents the colored side. Origami paper can be found in many hobby shops or purchased by mail from The Friends of The Origami Center of America, a non-profit organization of dedicated paperfolders. For more information about the Friends, send a self-addressed, business-size envelope with two first-class stamps to:

The Friends of The Origami Center of America  
15 West 77th St.  
New York, NY 10024-5192

Origami paper, and a catalog of other available craft books, can also be ordered from Dover Publications, Inc., at:

Dover Publications, Inc.  
31 East 2nd St.  
Mineola, NY 11501

Good Luck and Happy Folding!

John Montroll

# Contents

Symbols 6

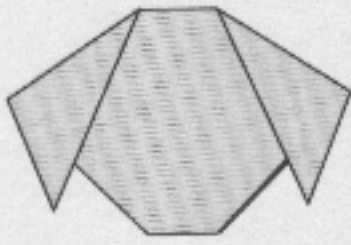

Dog  
Page 8

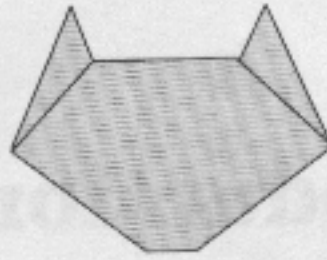

Cat  
Page 9

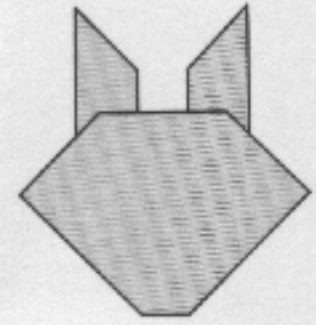

Rabbit  
Page 10

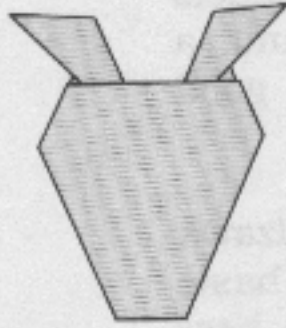

Horse  
Page 11

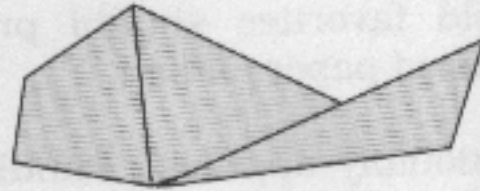

Fish  
Page 12

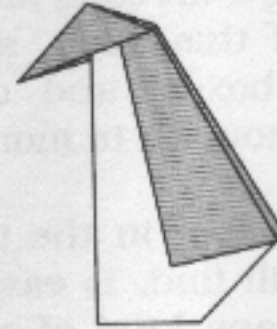

Penguin  
Page 13

Tulip  
Page 14



Stem  
Page 15

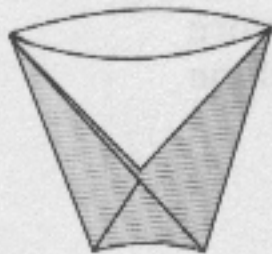

Cup  
Page 16

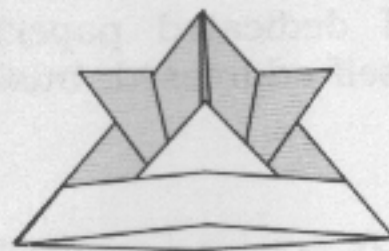

Hat  
Page 17

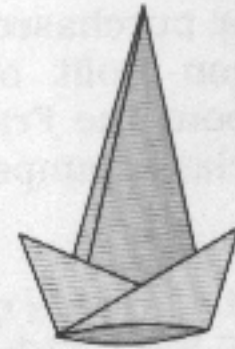

Tall Cap  
Page 18

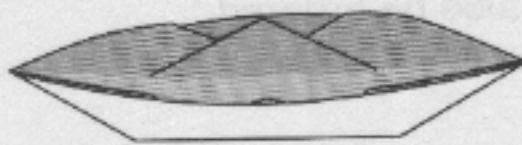

Boat  
Page 19

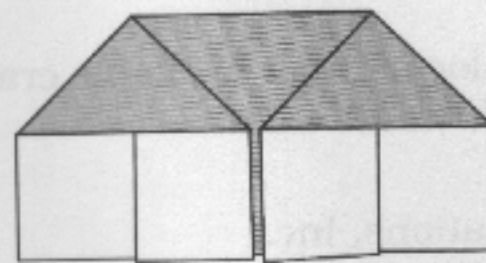

House  
Page 20

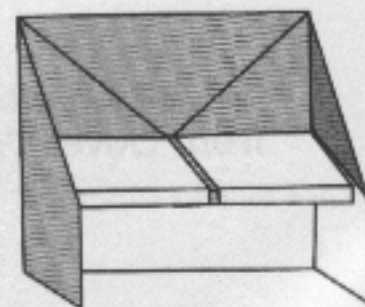

Piano  
Page 21

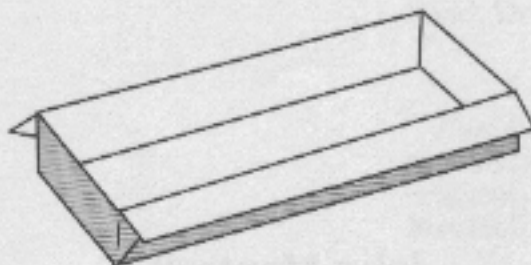

Oblong Box  
Page 22

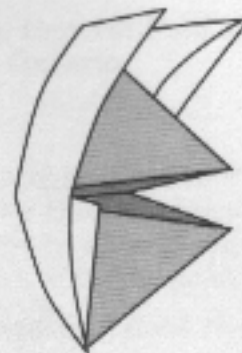

Fox  
Page 23

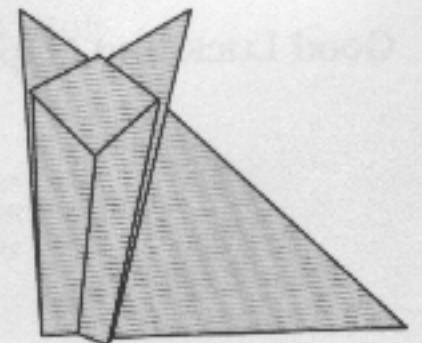

Sitting Fox  
Page 24

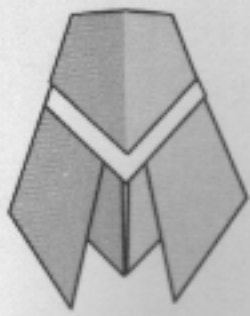

Cicada  
Page 25

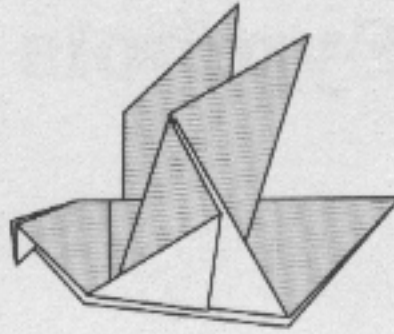

Pigeon  
Page 26

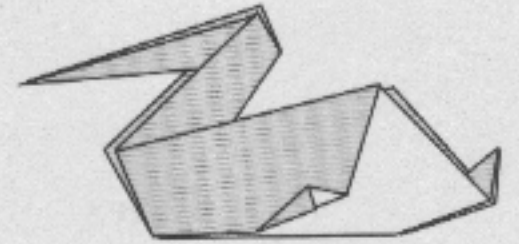

Pelican  
Page 27

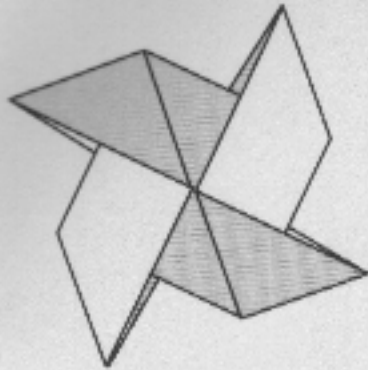

Pin Wheel  
Page 28

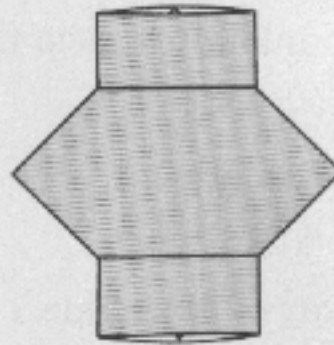

Lantern  
Page 29

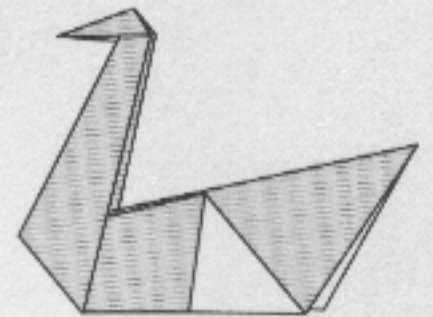

Swan  
Page 30



Star  
Page 31

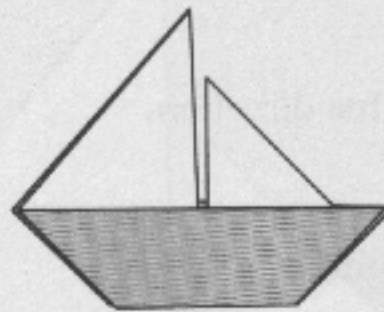

Sailboat  
Page 32

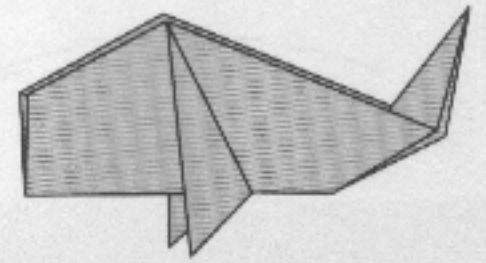

Carp  
Page 34

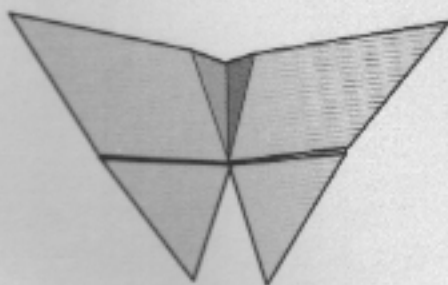

Butterfly  
Page 36

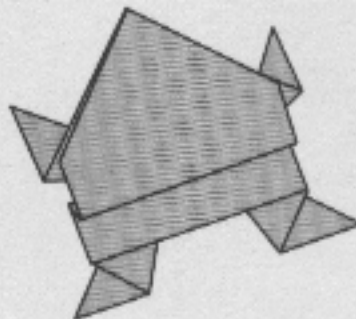

Frog  
Page 38

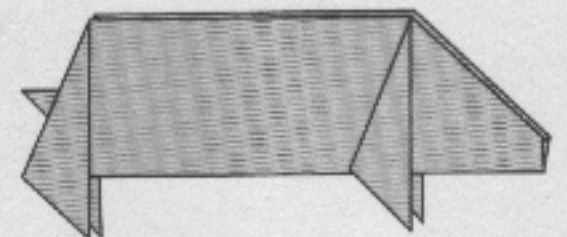

Pig  
Page 40

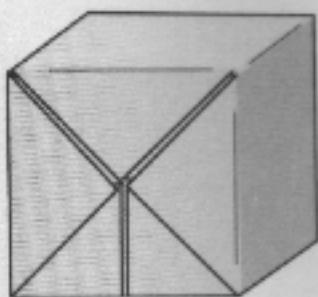

Waterbomb  
Page 42

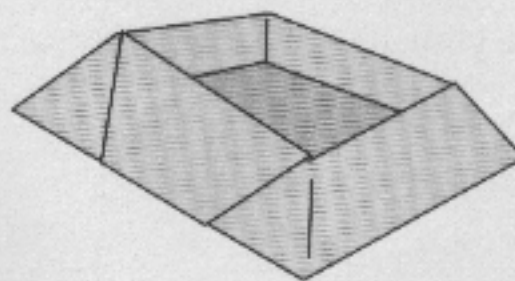

Candy Box  
Page 44

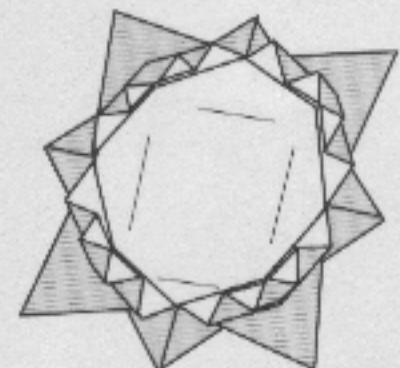

Fancy Box  
Page 46

# Symbols

## Lines

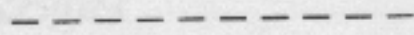

Valley fold, fold in front.

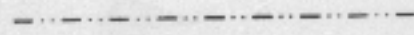

Mountain fold, fold behind.

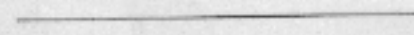

Crease line.

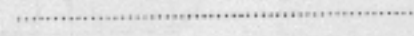

X-ray or guide line.

## Arrows



Fold in this direction.

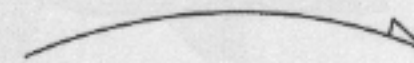

Fold behind.

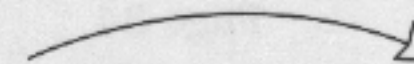

Unfold.

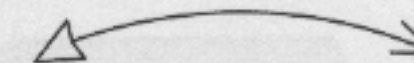

Fold and unfold.



Turn over.



Push.



Place your finger between these layers.

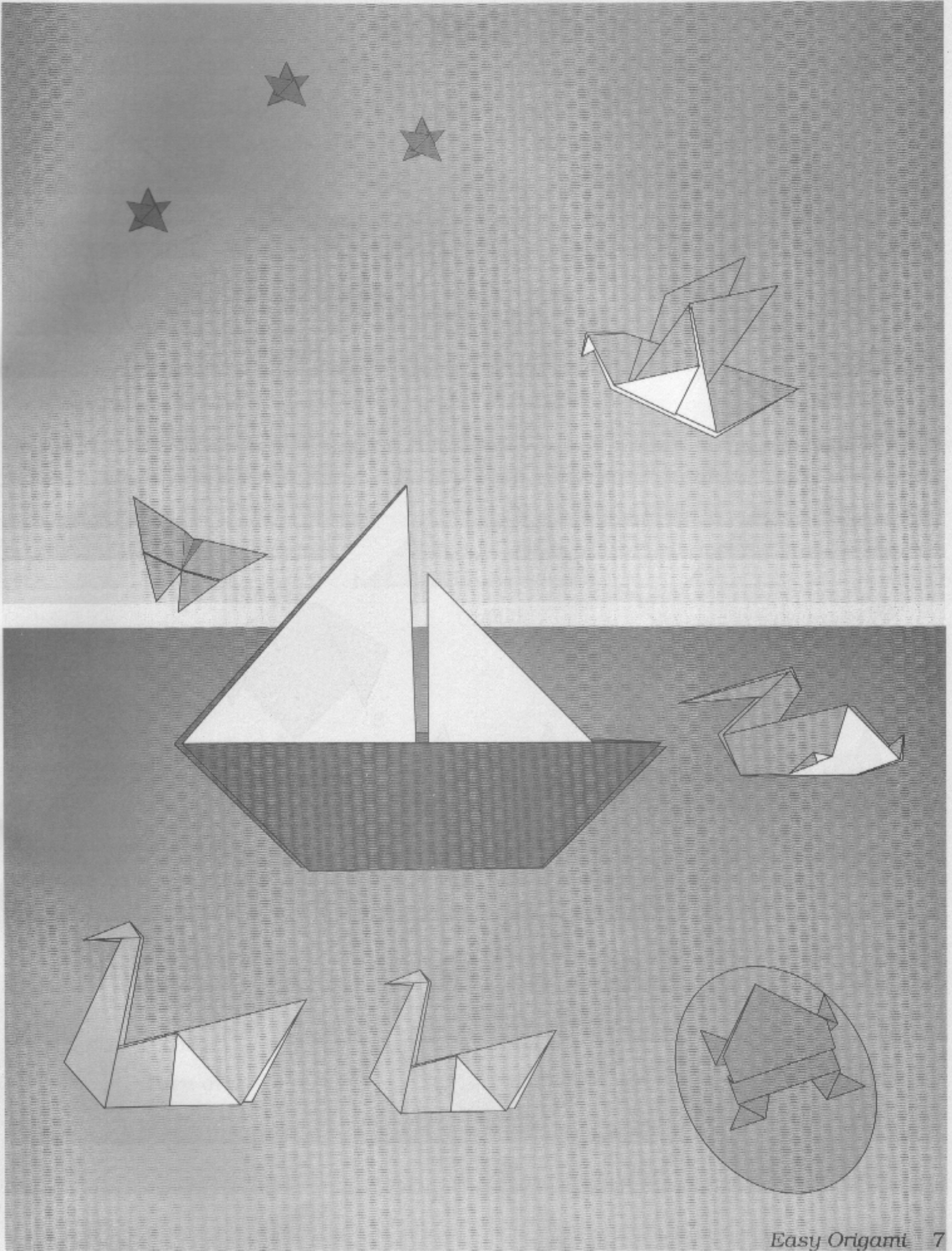

# Dog

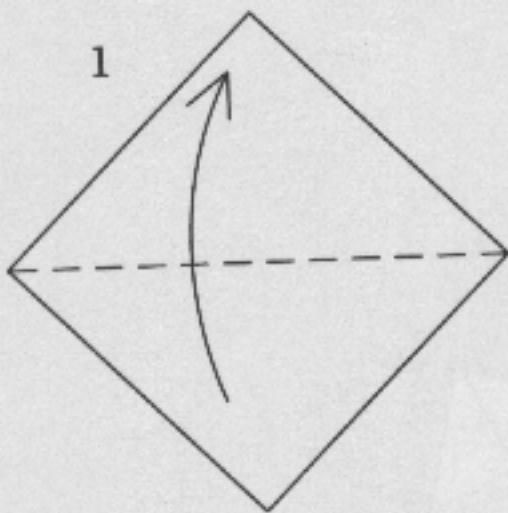

Fold in half.

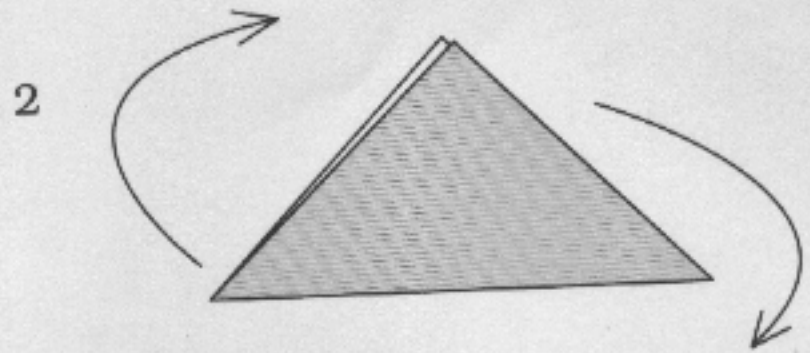

Rotate.

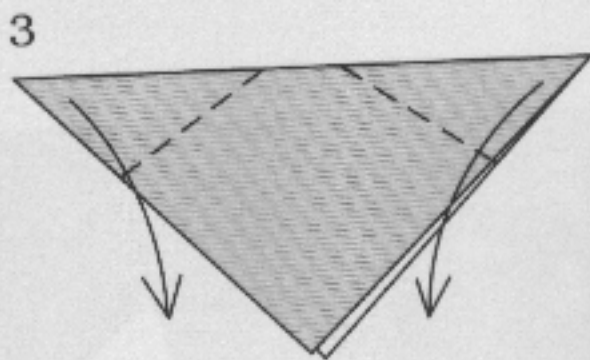

Fold the ears down.

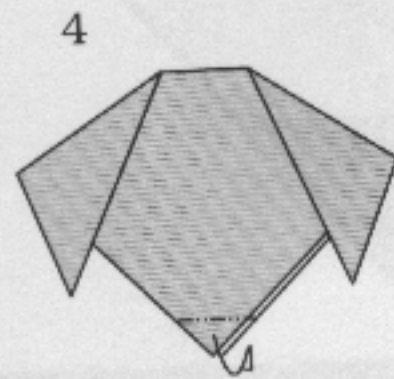

Fold behind.

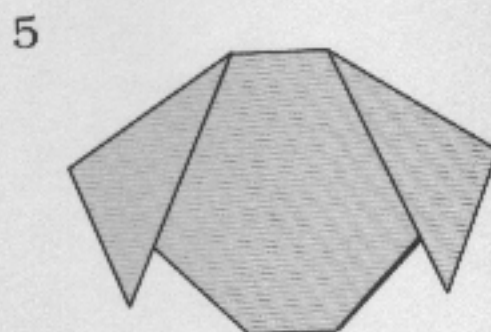

Dog

# Cat

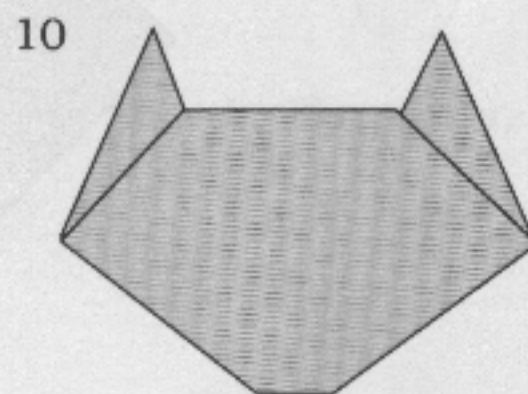
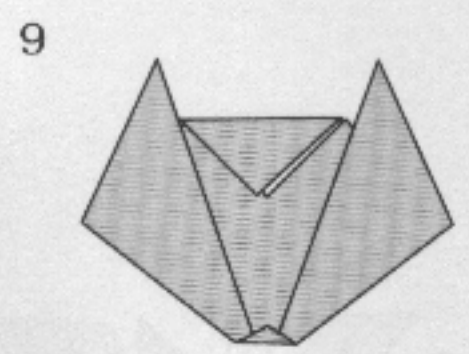
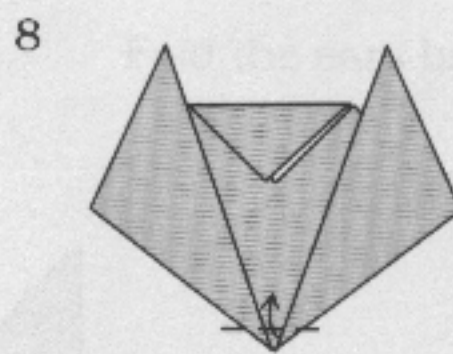
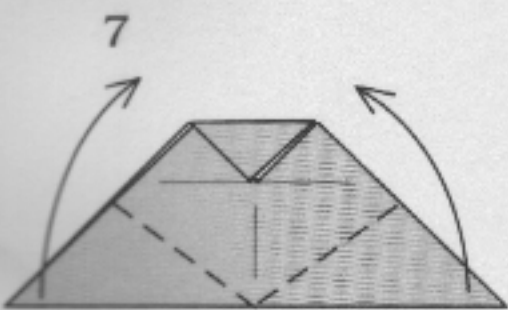
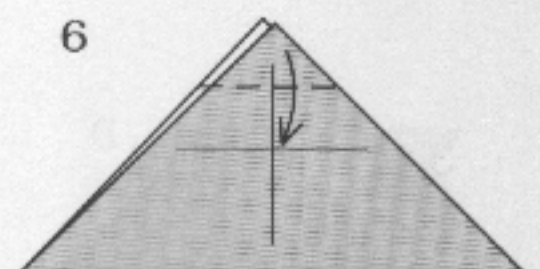
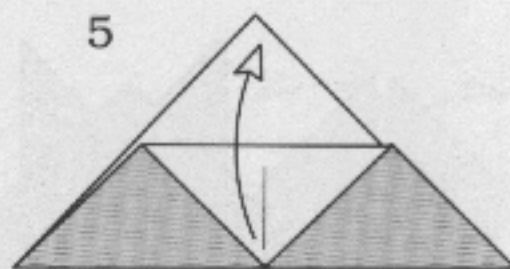
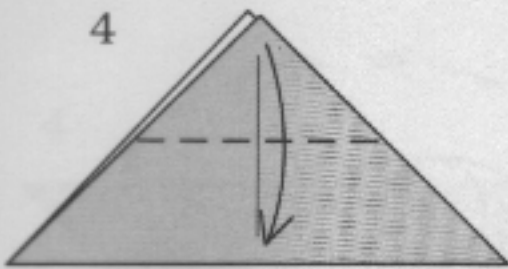
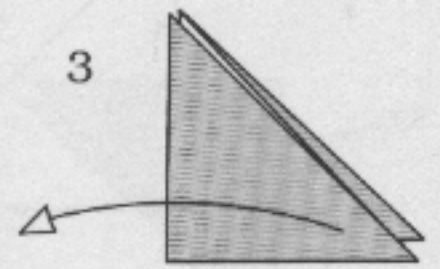
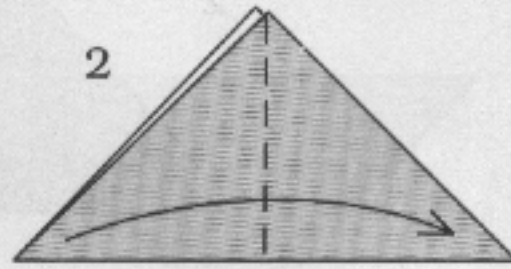
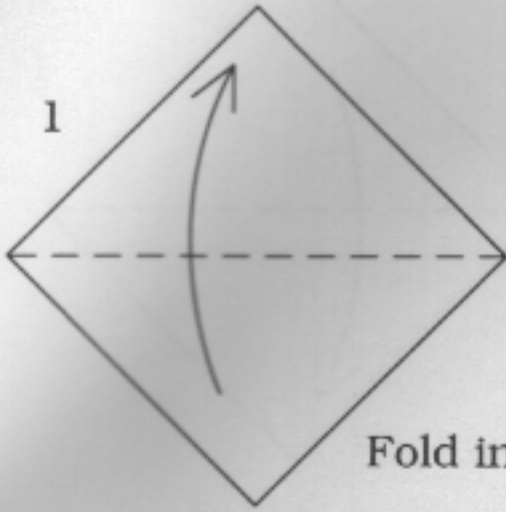

# Rabbit

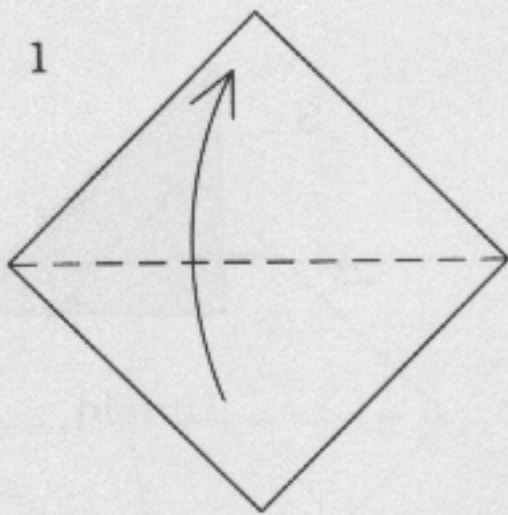

Fold in half.

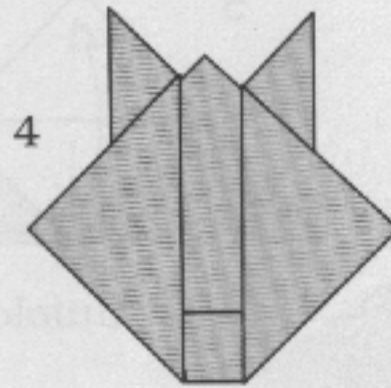
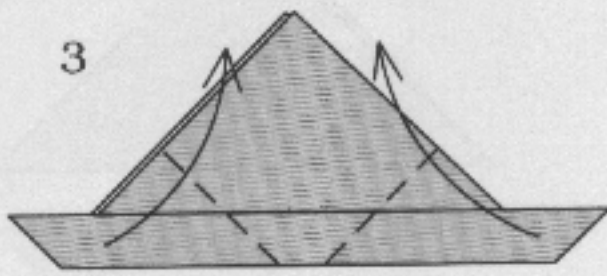
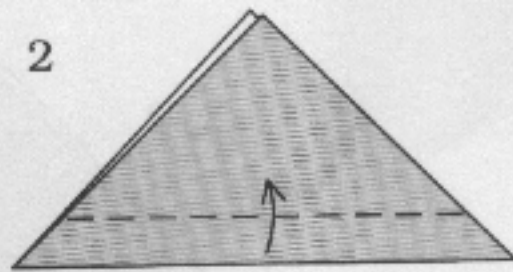

Turn over.

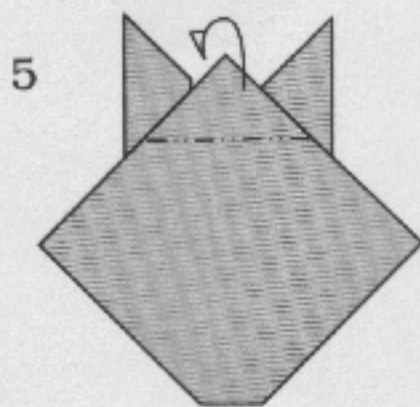

Fold behind.

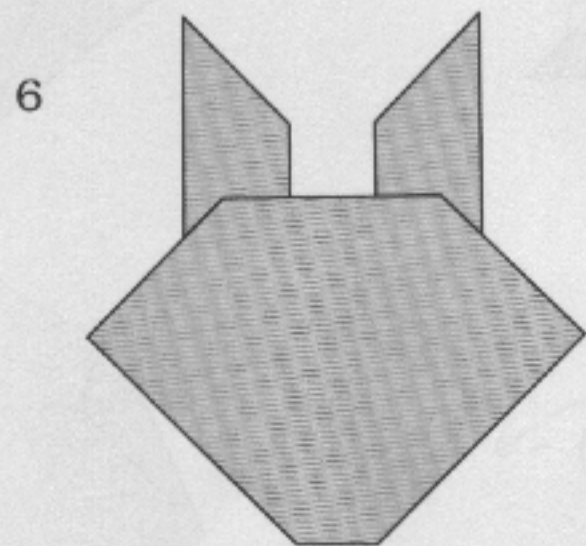

Rabbit

# Horse

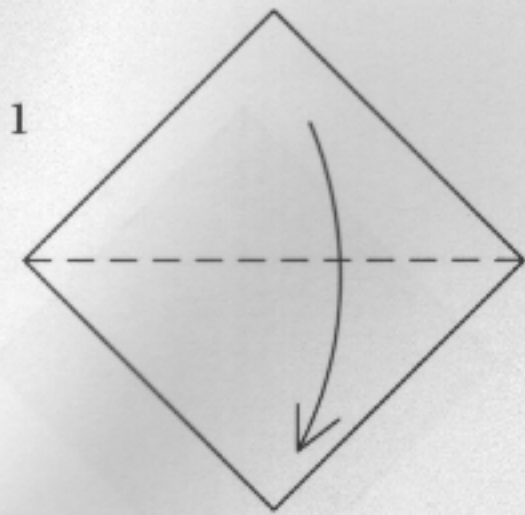

Fold in half.

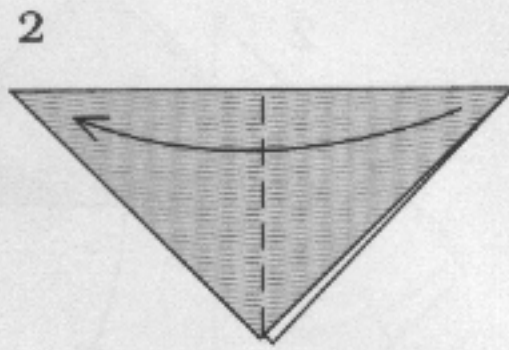

Fold in half.

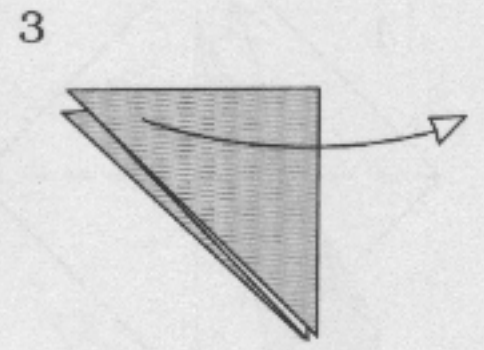

Unfold.

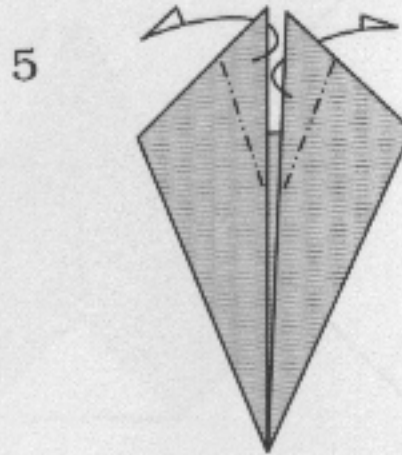
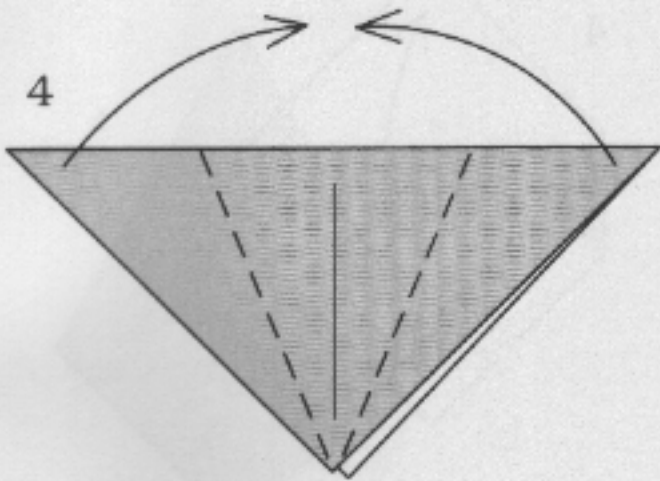

Fold the ears behind.

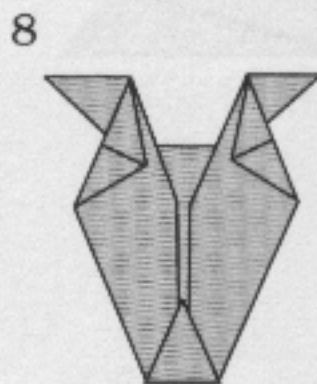
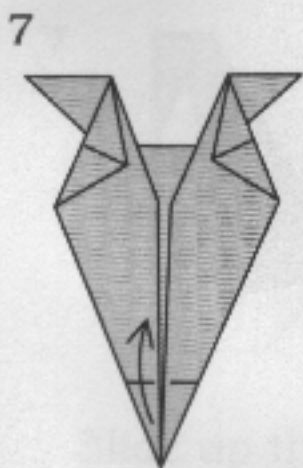
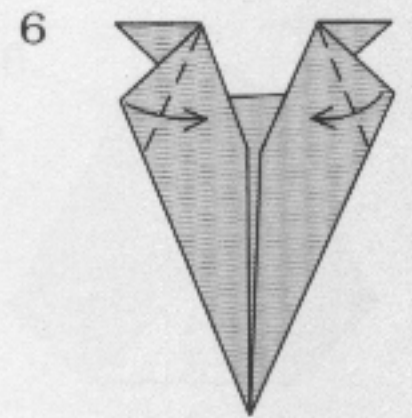

Turn over.

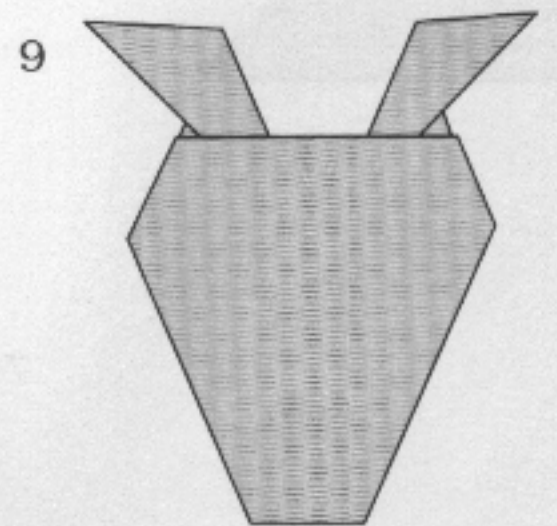

Horse

# Fish

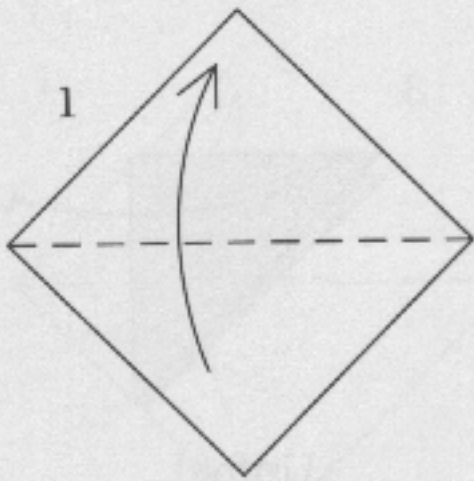

Fold in half.

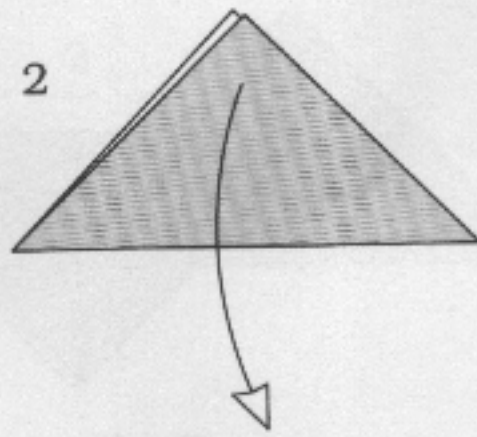

Unfold.

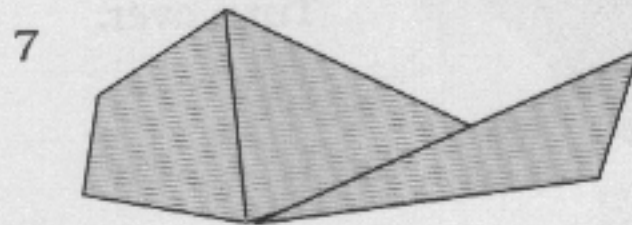
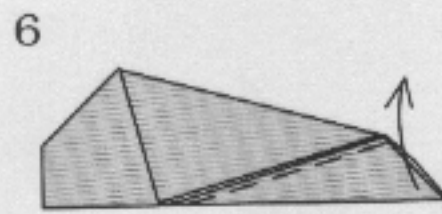
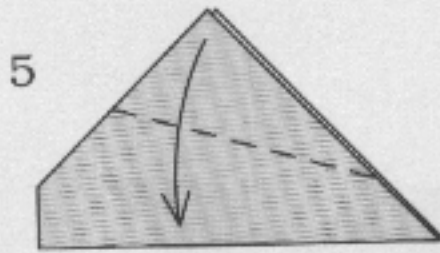
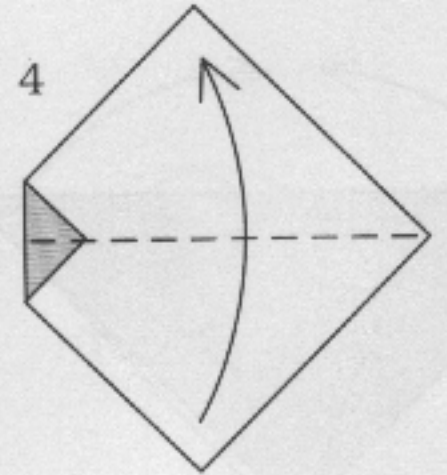
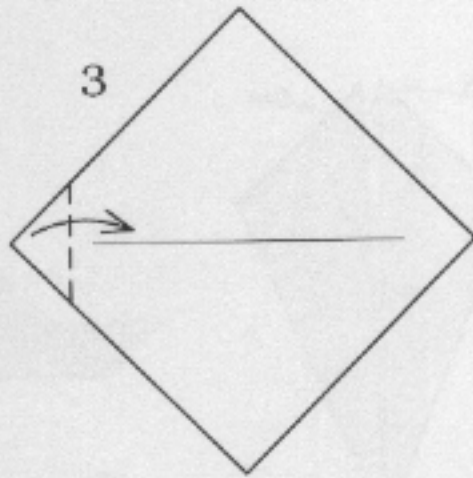

Fish

# Penguin

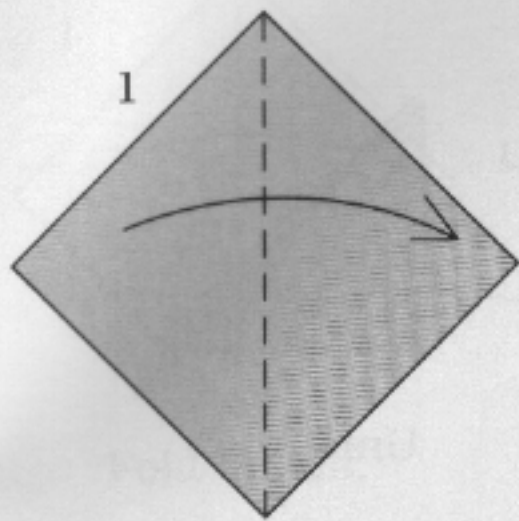

1  
Fold in half.

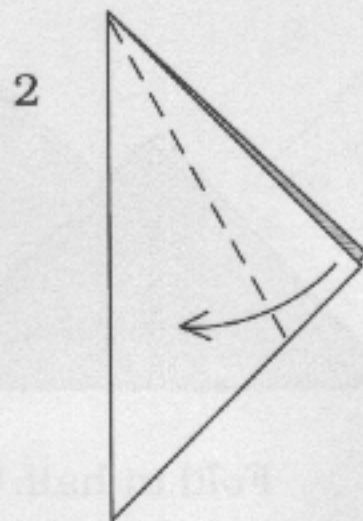

2  
Repeat behind.

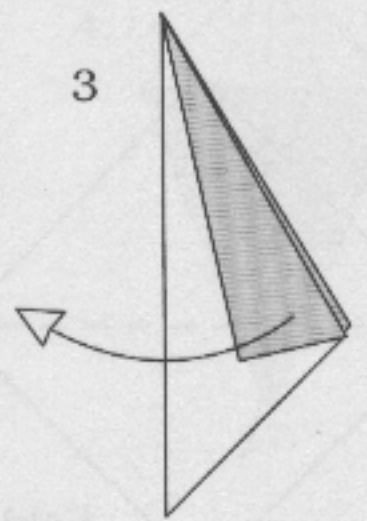

3  
Unfold.

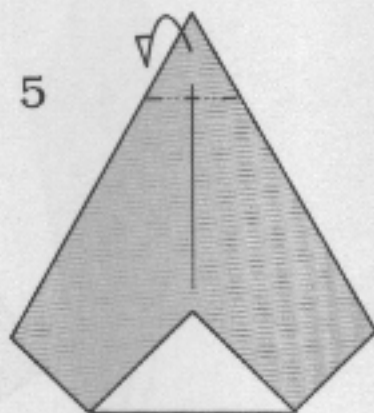
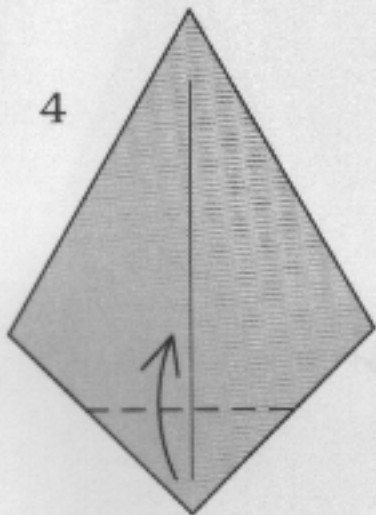

4  
Fold behind.

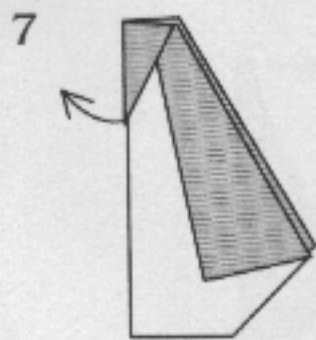
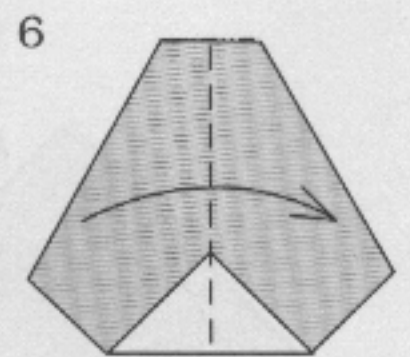

5  
Fold behind.

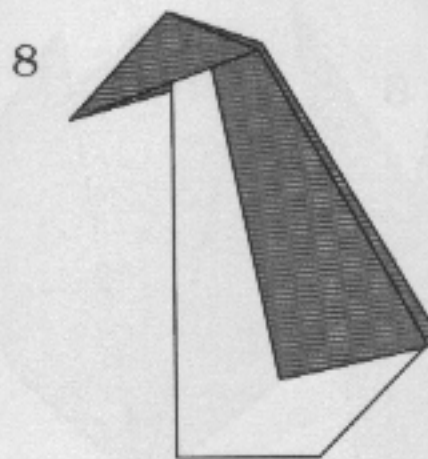

6  
Slide up the head.

8  
Penguin

# Tulip

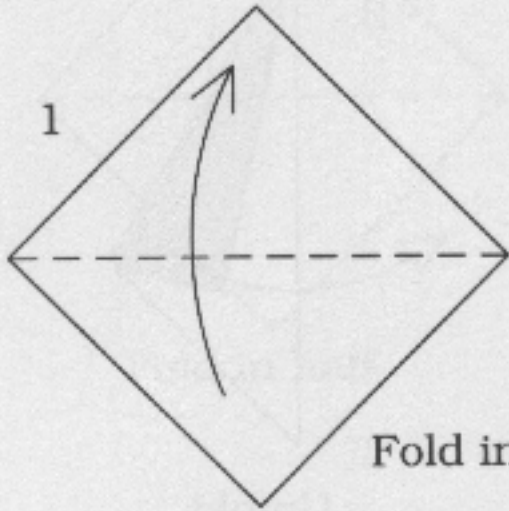

Fold in half.

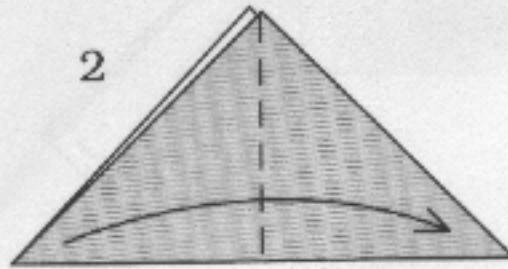

Fold in half.

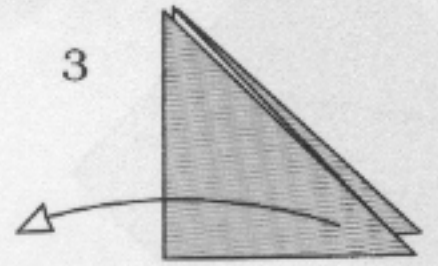

Unfold.

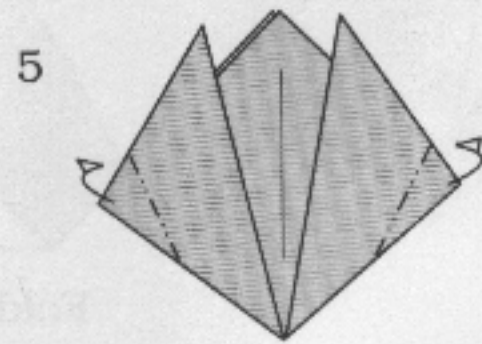
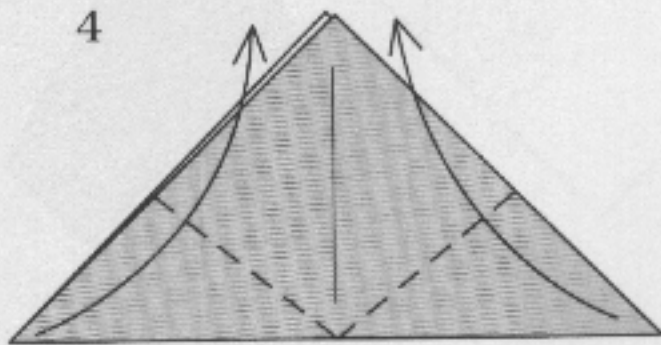

Fold behind.

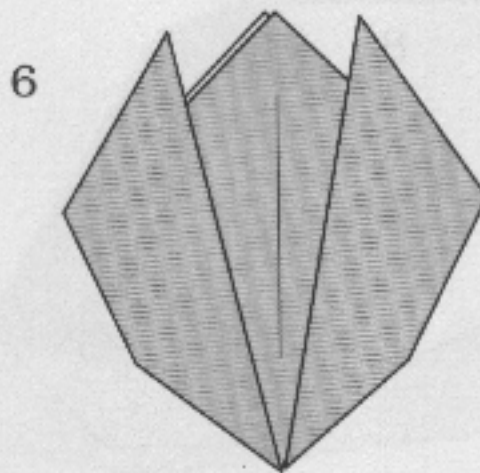

Tulip

# Stem

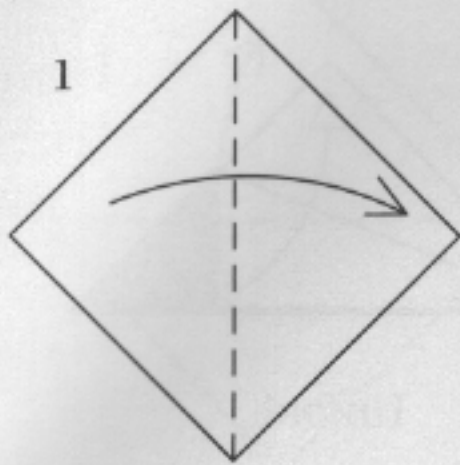

Fold in half.

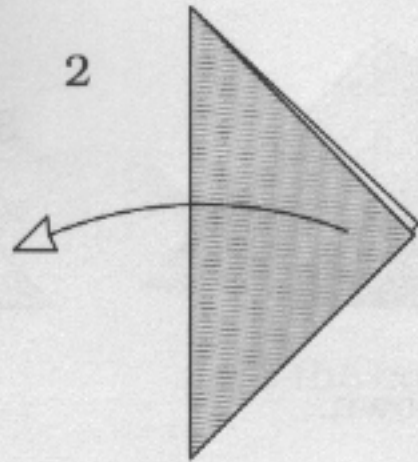

Unfold.

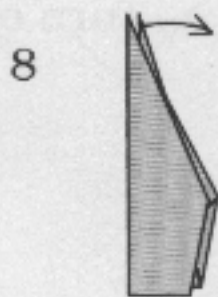
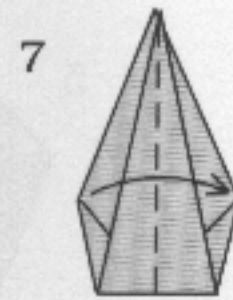
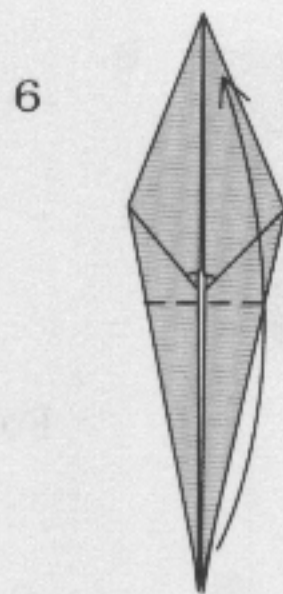
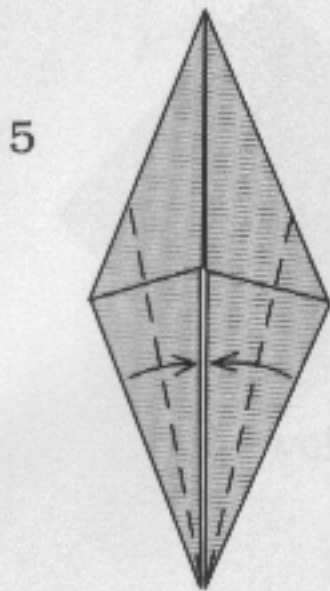
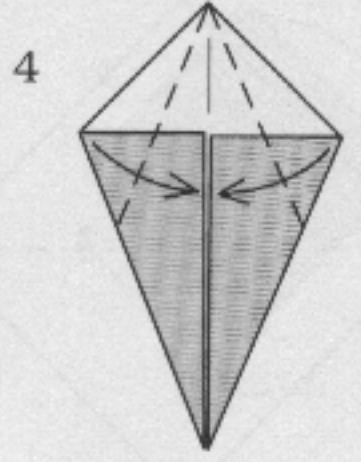
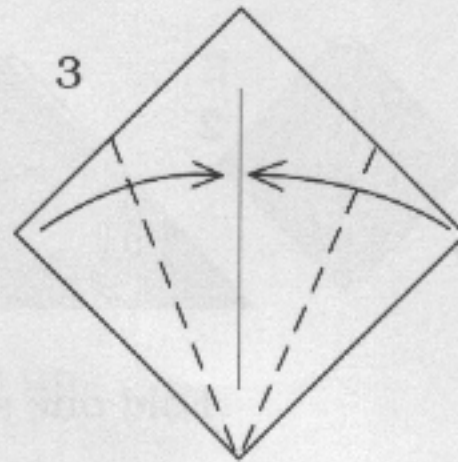

Slide out.

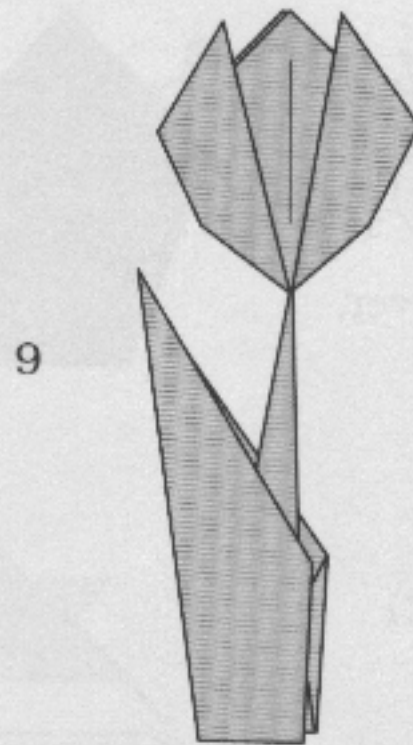

Tulip

Stem

# Cup

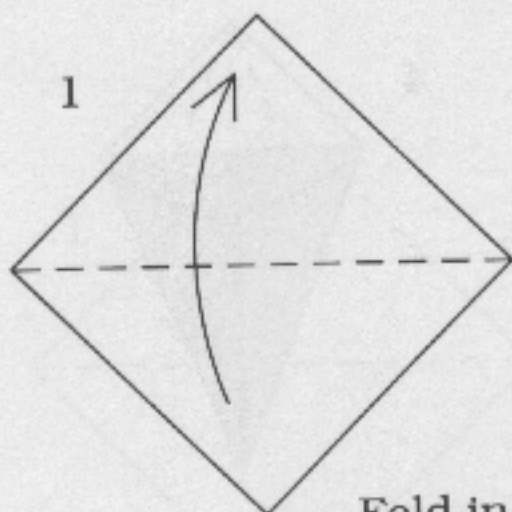

Fold in half.

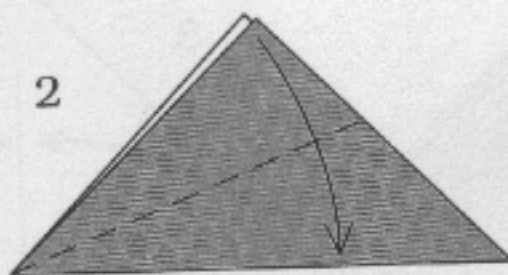

Fold one side down.

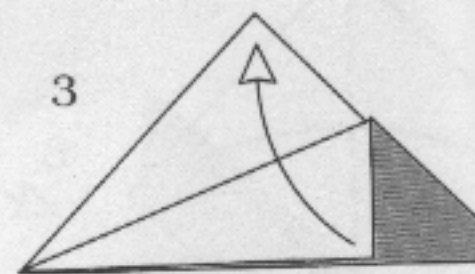

Unfold.

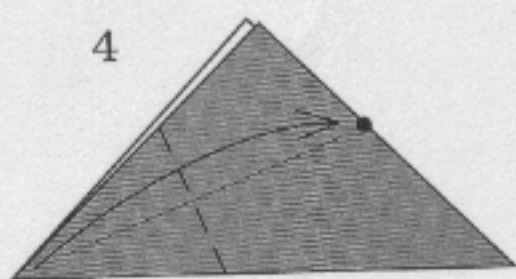

Fold the corner to the dot.

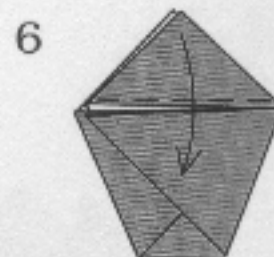
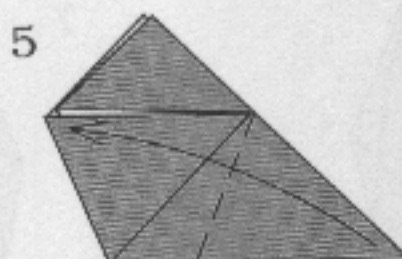

Fold one layer down.

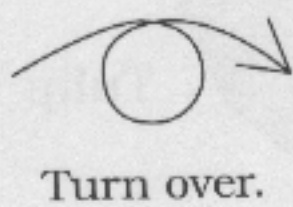
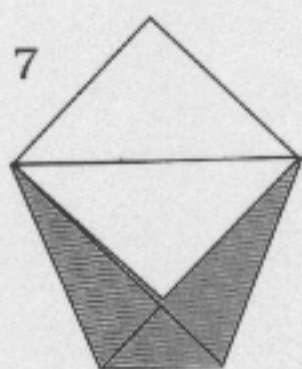

Turn over.

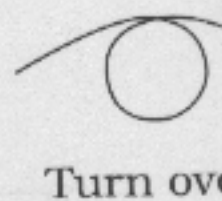
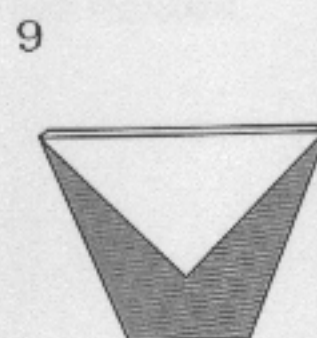
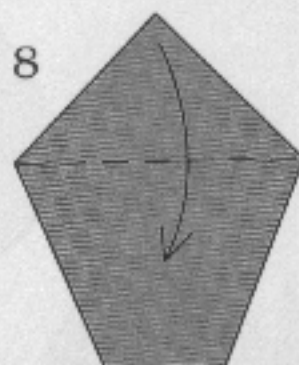

Turn over.

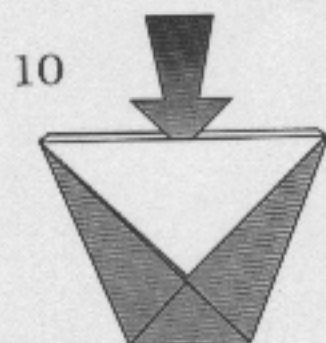

Place your finger inside to open the cup.

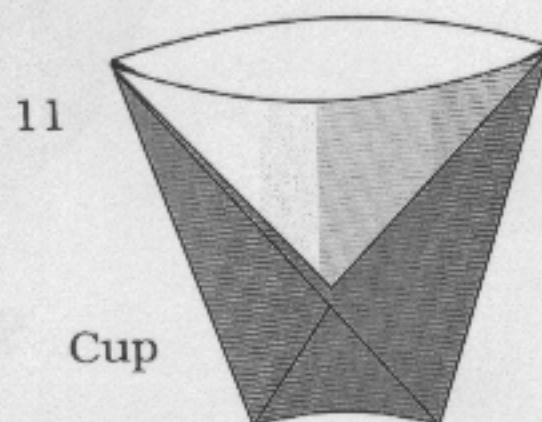

Cup

# Hat

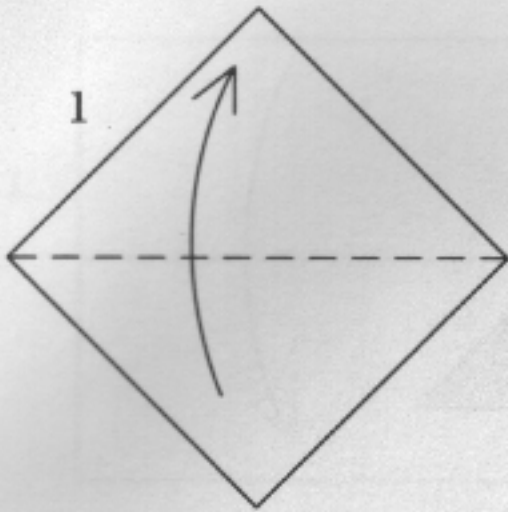

Fold in half.

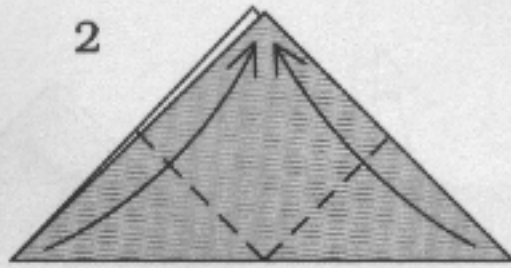

Fold the corners up.

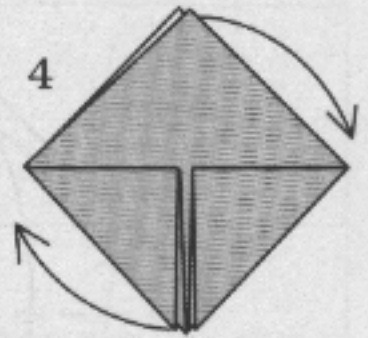
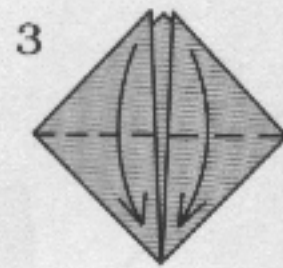

Rotate.

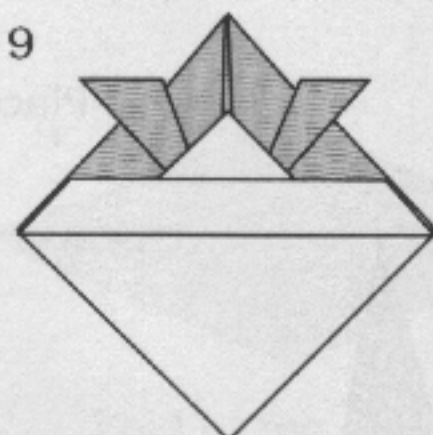
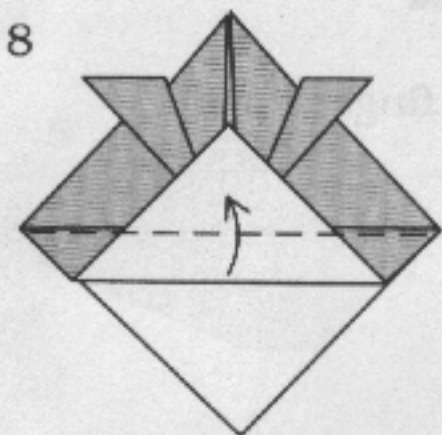
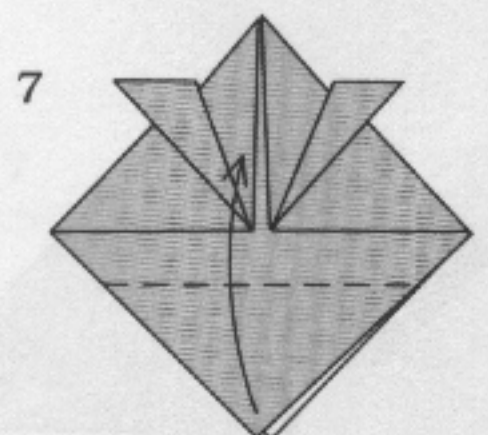
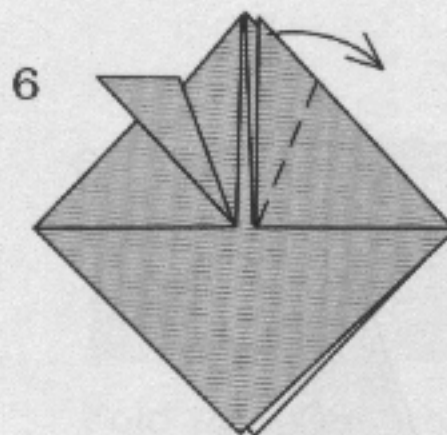
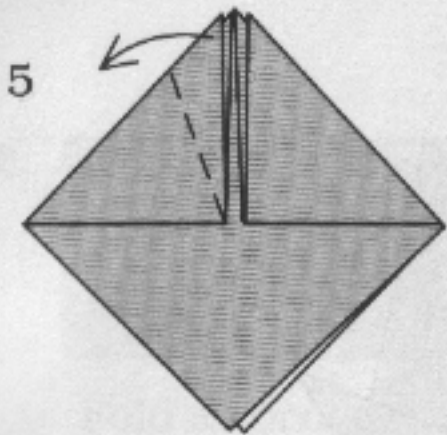

Turn over.

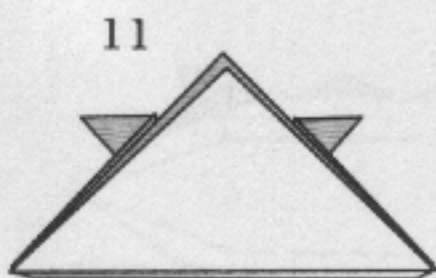
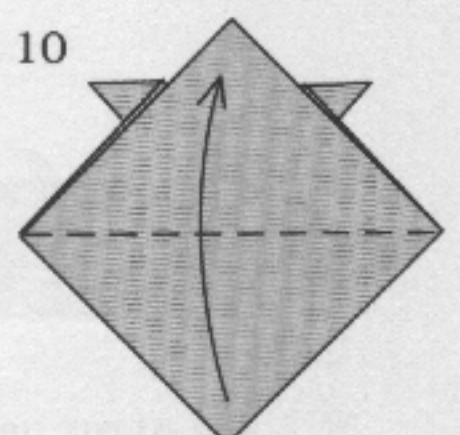

Turn over.

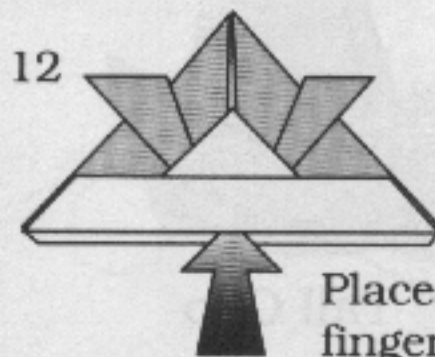

Place your finger inside to open the hat.

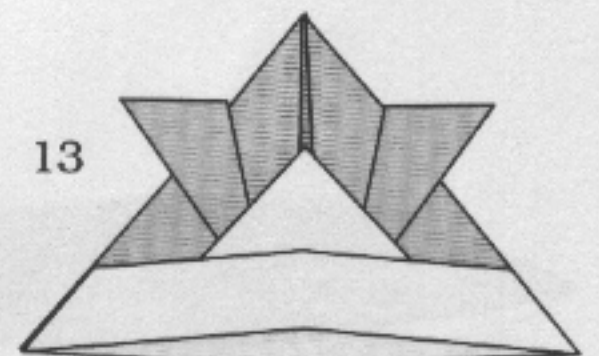

Hat

# Tall Cap

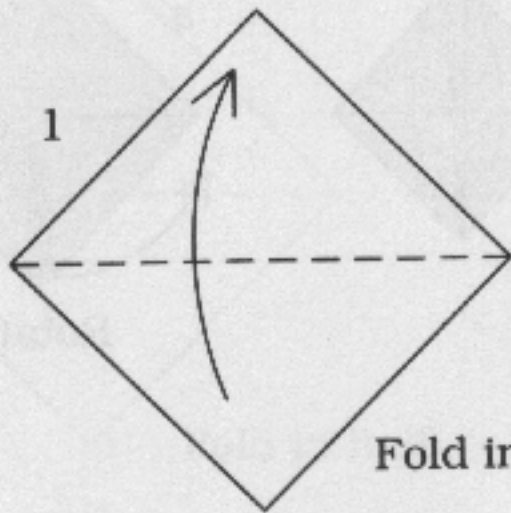

Fold in half.

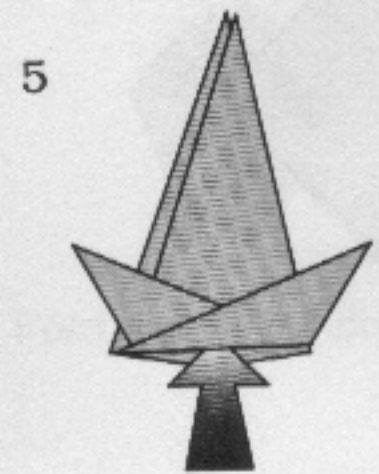
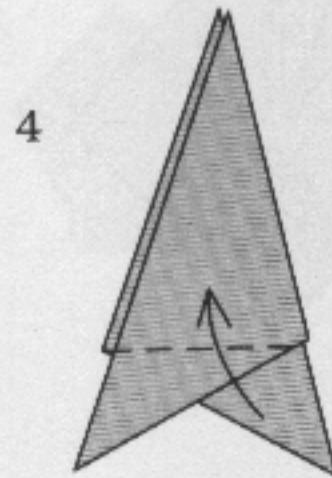
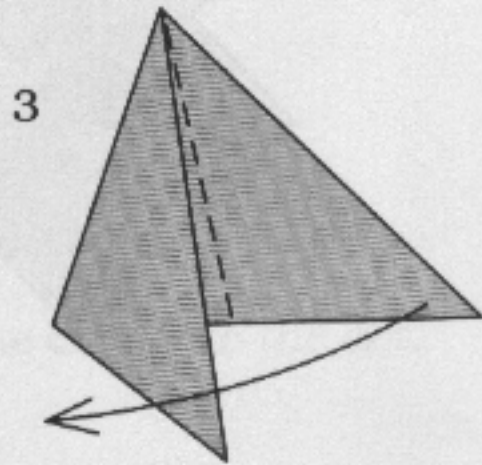
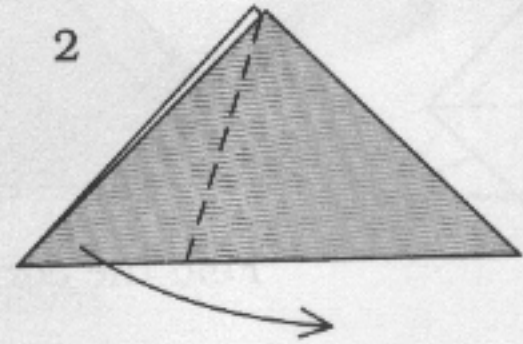

Place your finger inside.

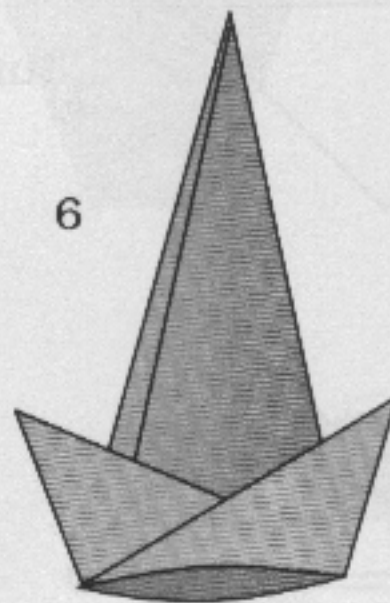

Tall Cap

# Boat

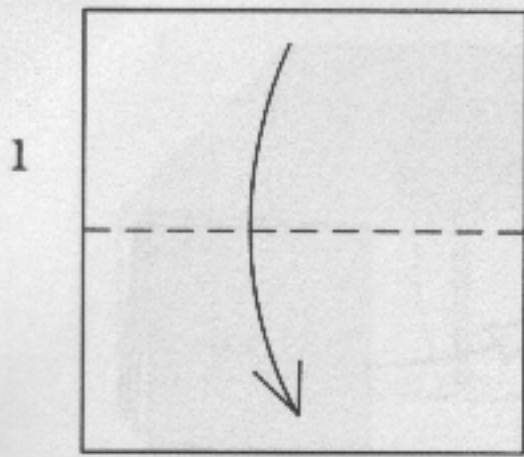

Fold in half.

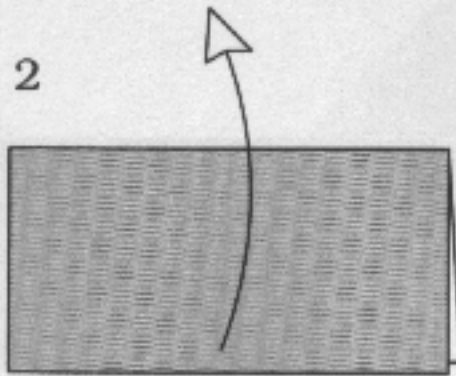

Unfold.

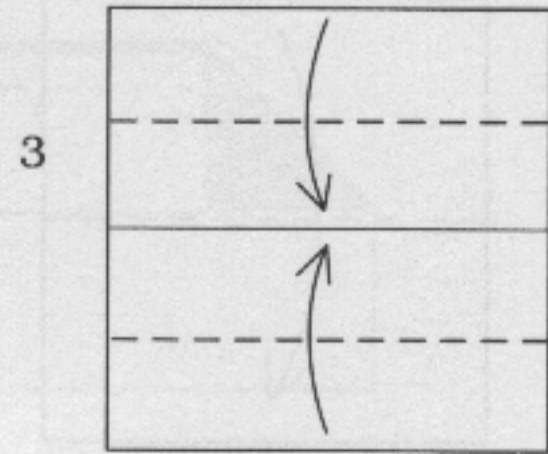

Fold to the center.

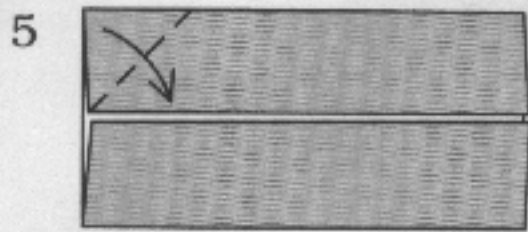

Fold a corner towards the center.

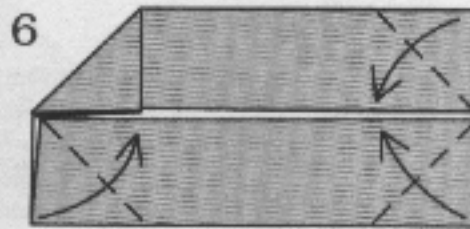

Fold the other corners towards the center.

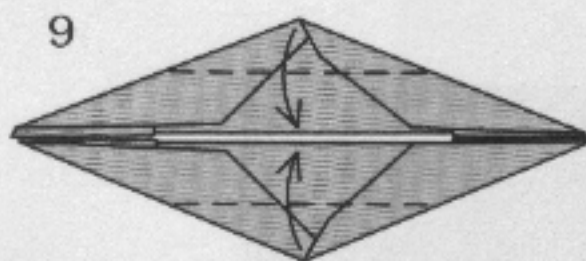
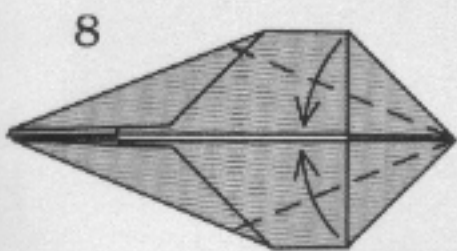
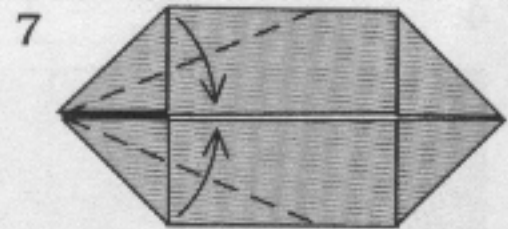

Fold to the center.

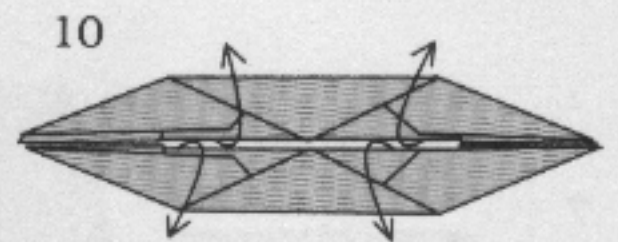

Open up to see the white paper.

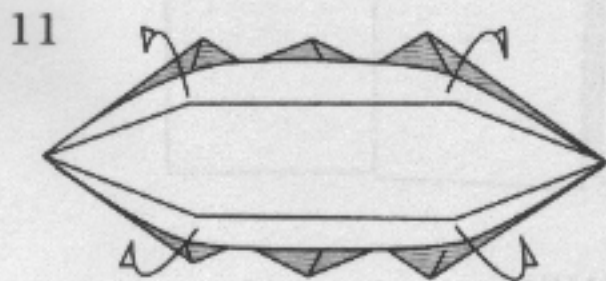

Fold inside-out and turn over.

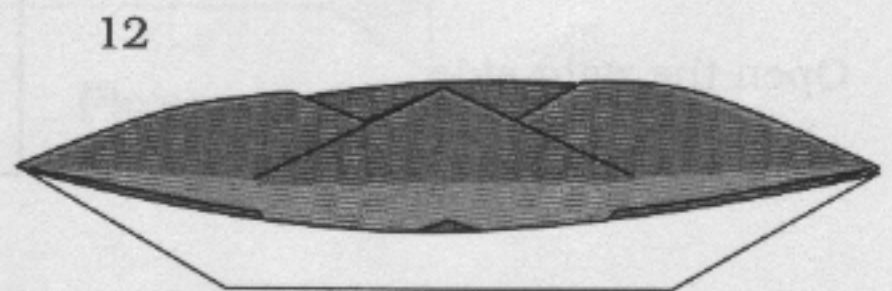

Boat

# House

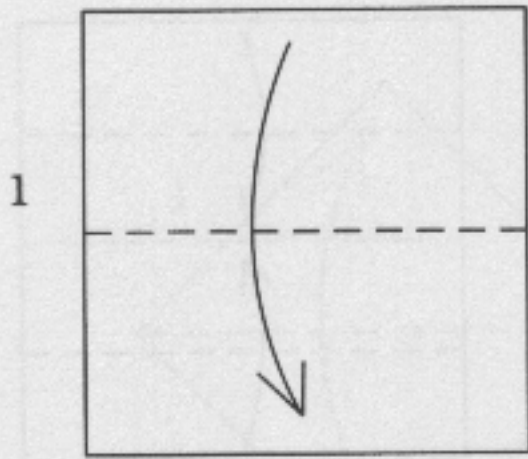

Fold in half.

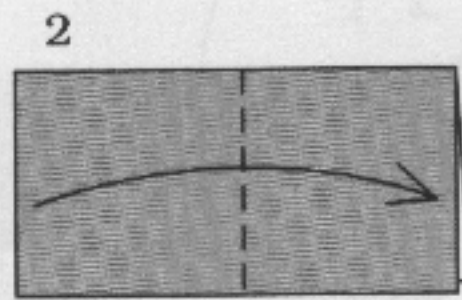

Fold in half.

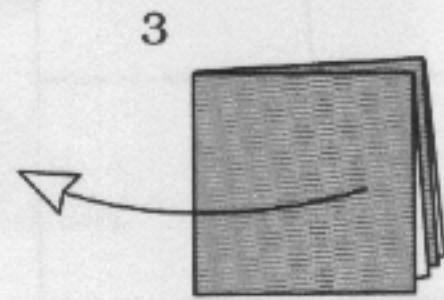

Unfold.

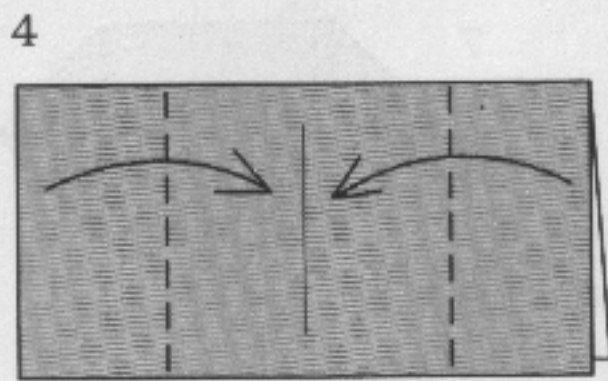

Fold to the center.

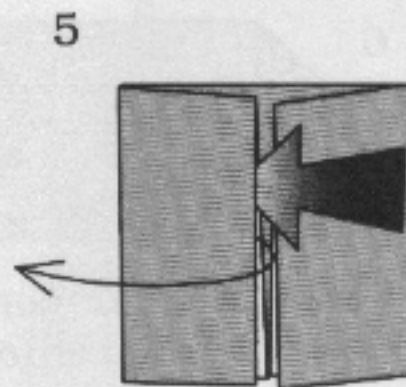

Place your finger inside to open.

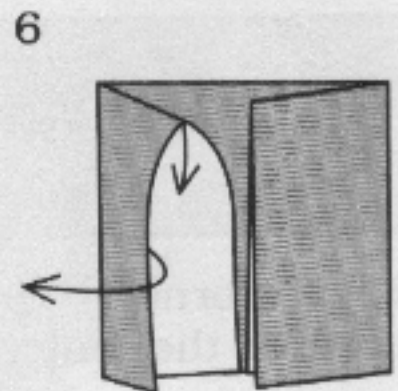

Continue opening the model.

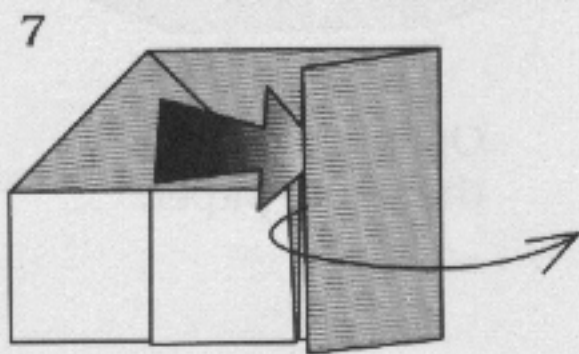

Open the right side.

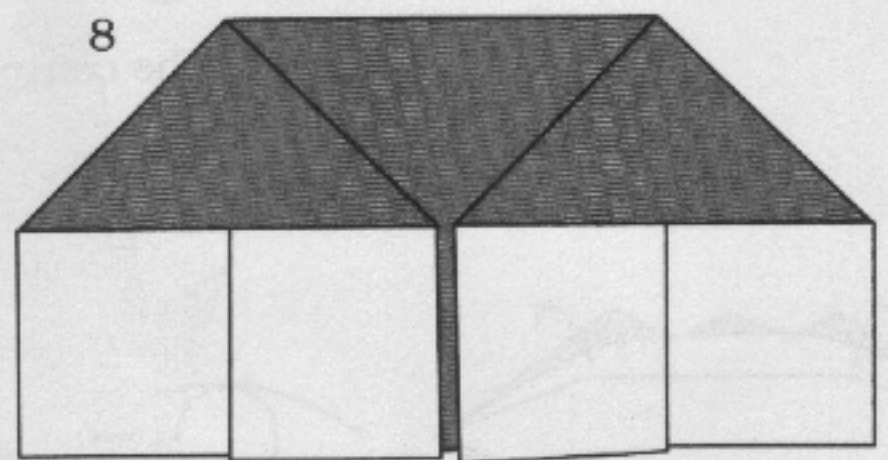

House

# Piano

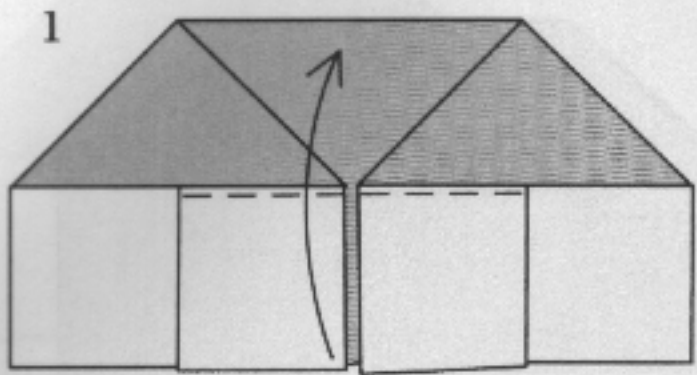

Begin with the house.

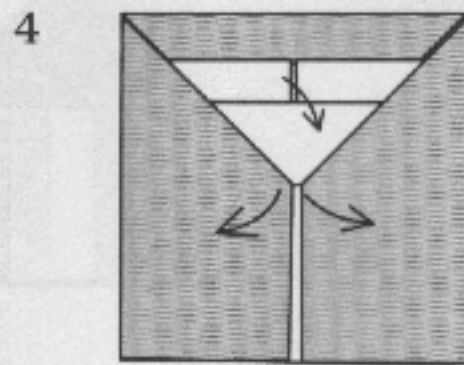
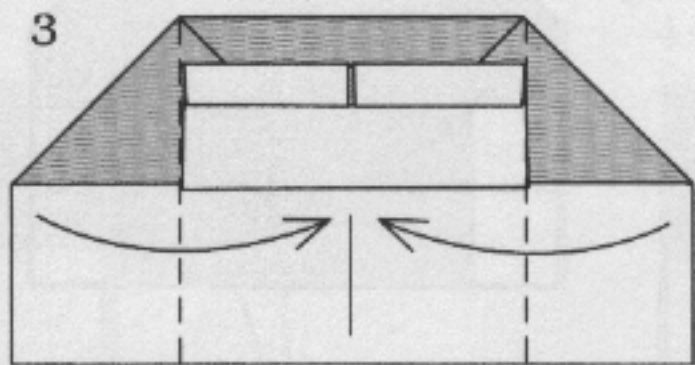
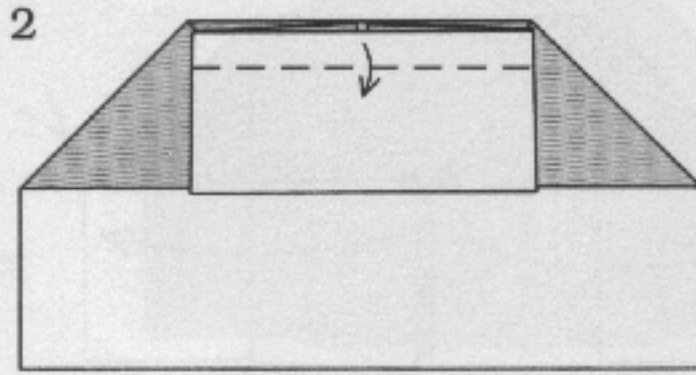

Open.

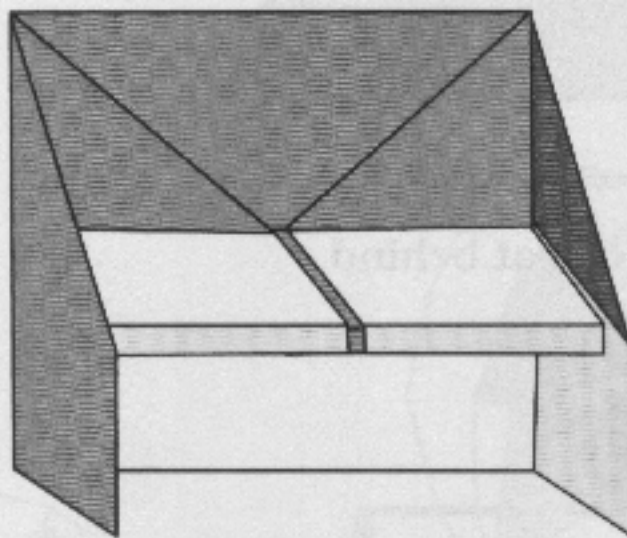

Piano

# Oblong Box

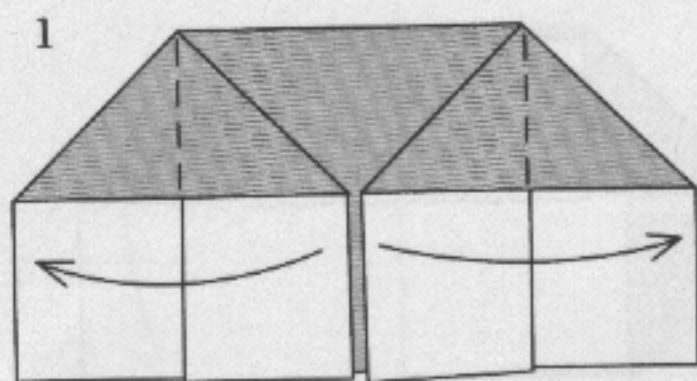

Begin with the house.

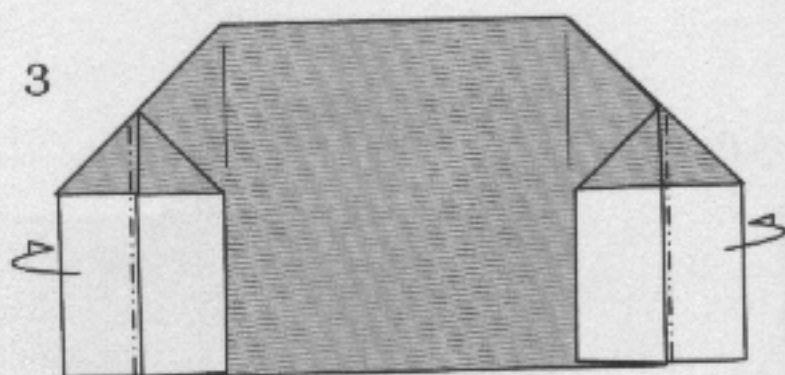
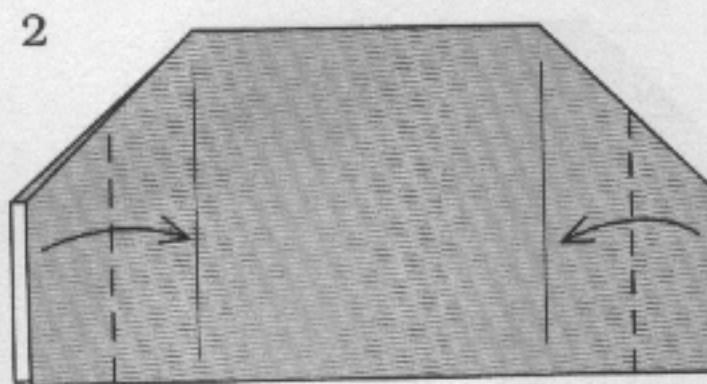

Fold behind.

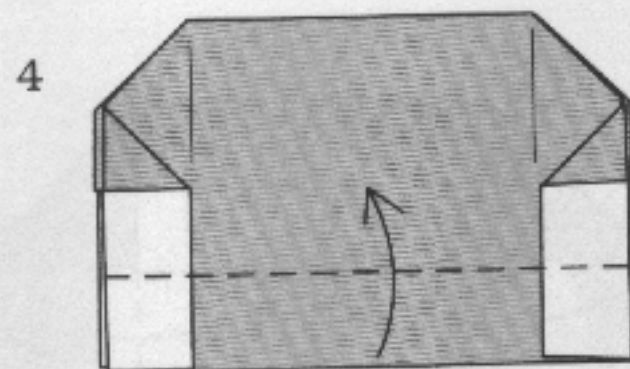

Repeat behind.

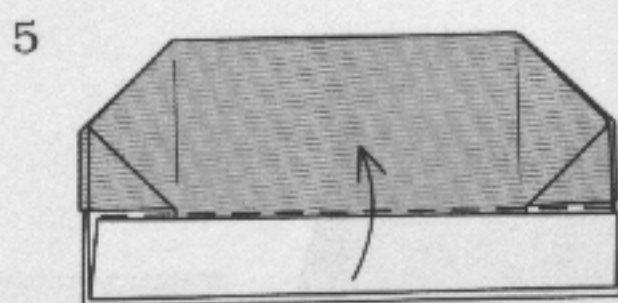

Repeat behind.

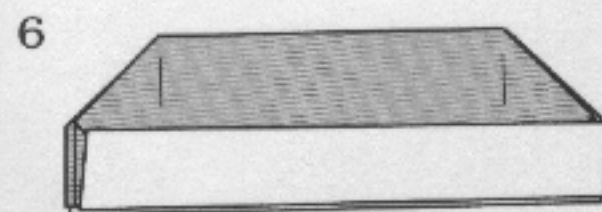

Rotate.

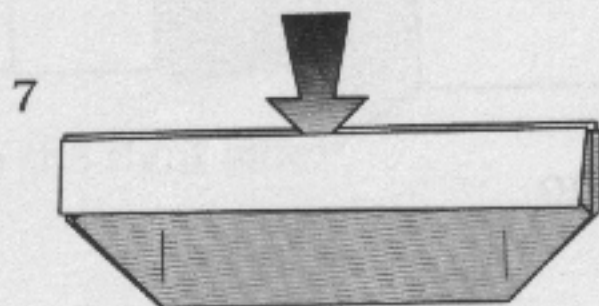

Open the box.

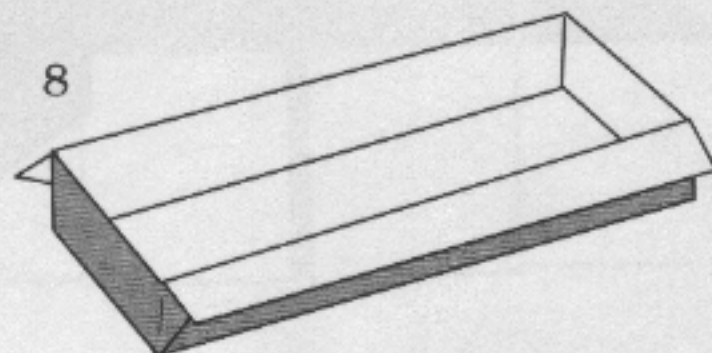

Oblong Box

# Fox

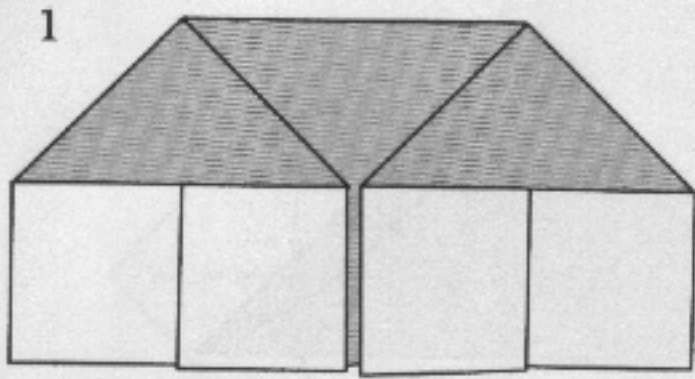

Begin with the house.



Turn over.

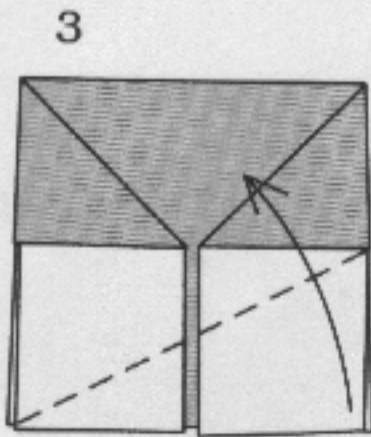
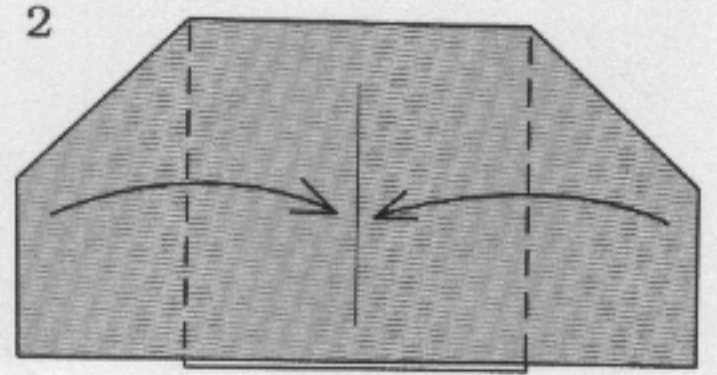

Fold up, repeat behind.

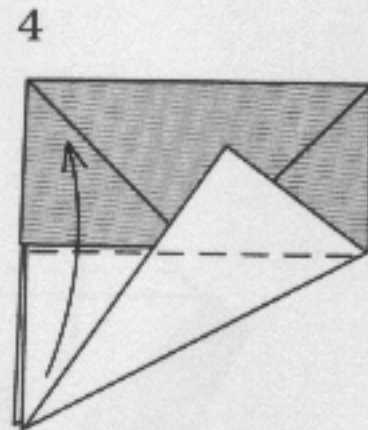

Fold up, repeat behind.

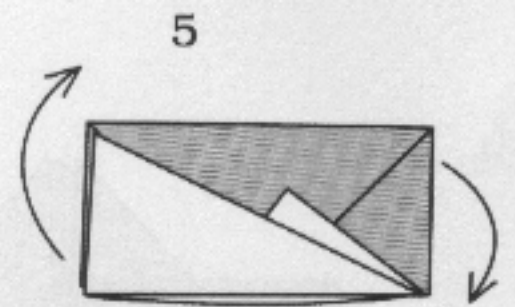

Rotate.

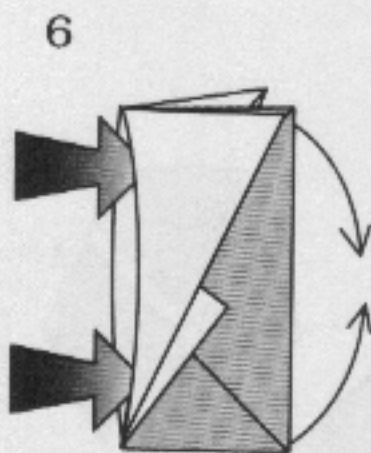

Place your finger and thumb inside to shape the mouth.

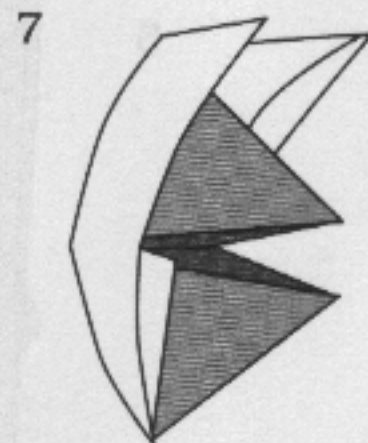

Fox

# Sitting Fox

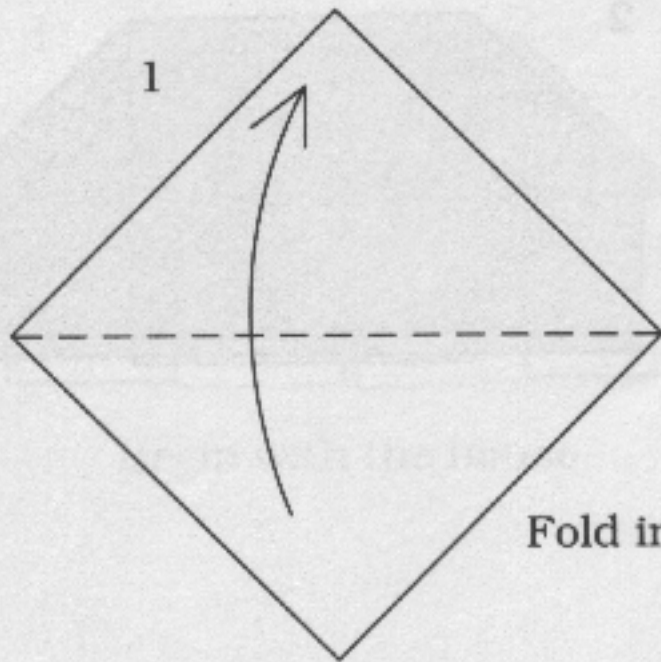

Fold in half.

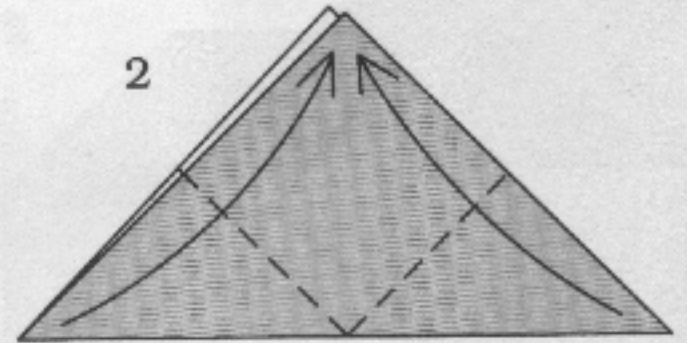

Fold the corners up.

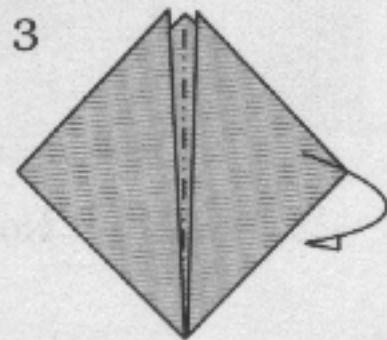

Fold behind.

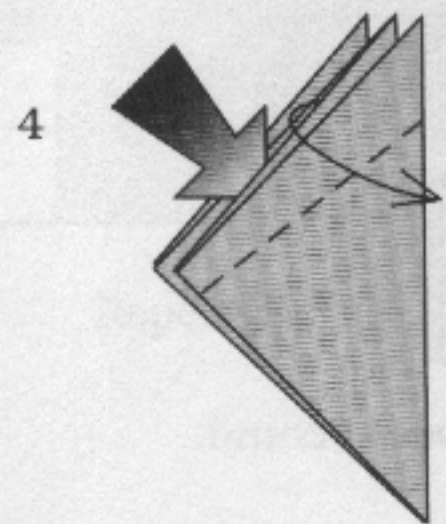

Open and rotate.

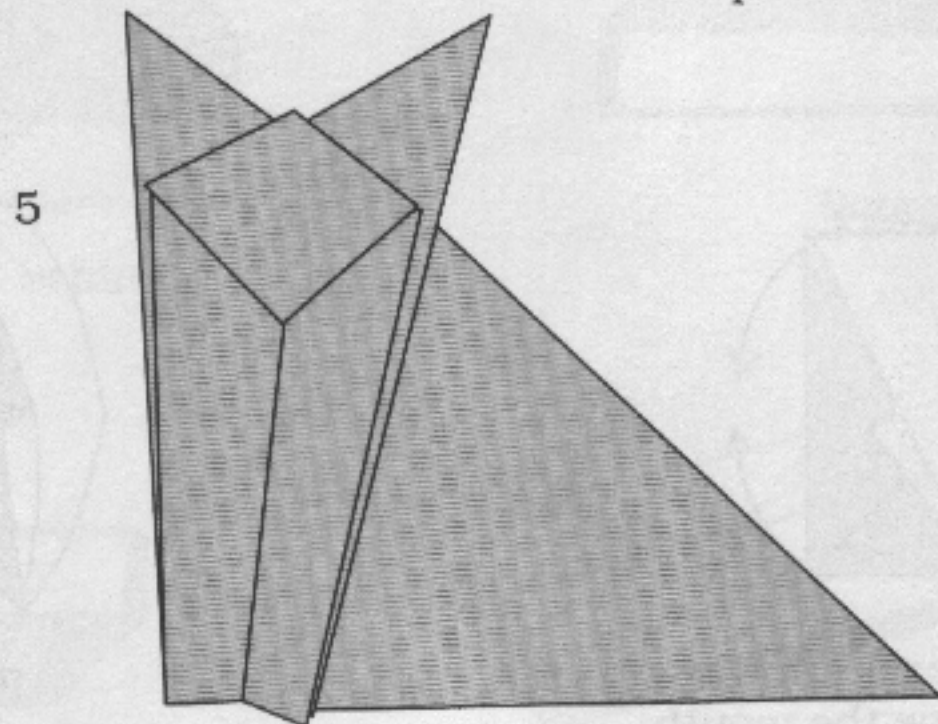

Sitting Fox

# Cicada

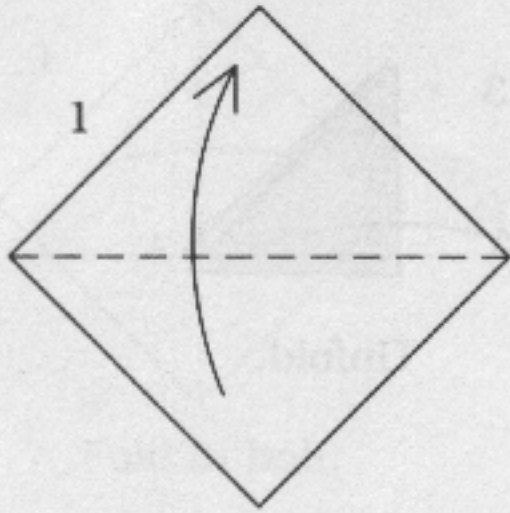

Fold in half.

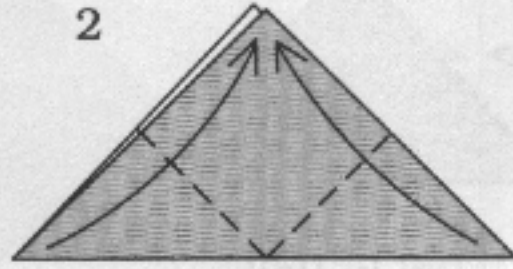

Fold the corners up.

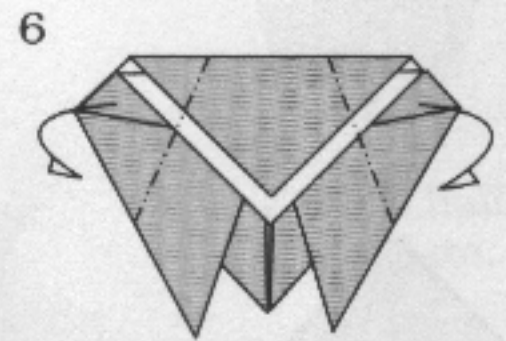
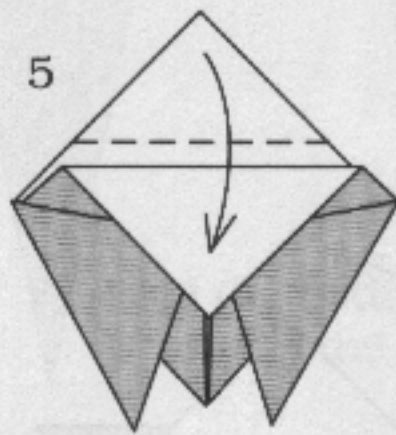
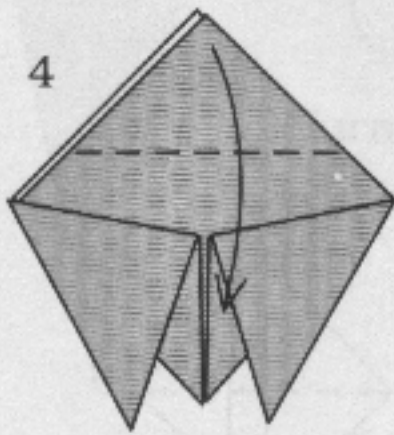
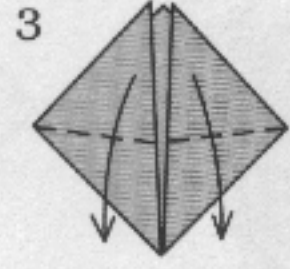

Fold behind.

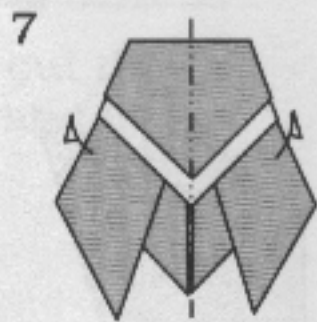

Bend in half.

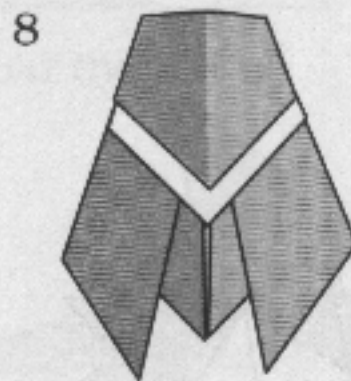

Cicada

# Pigeon

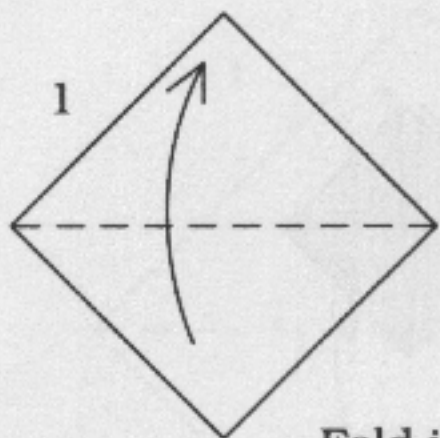

Fold in half.

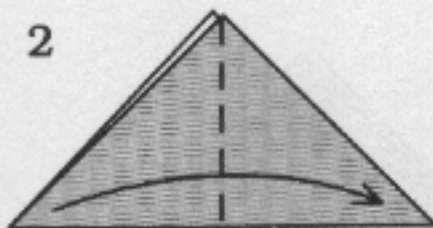

Fold in half.

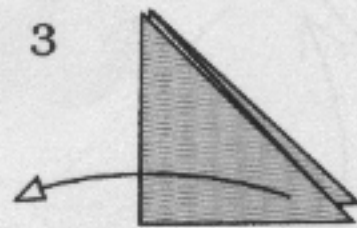

Unfold.

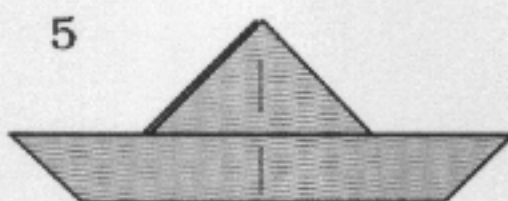
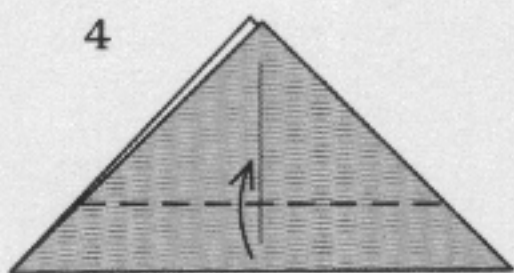

Turn over.

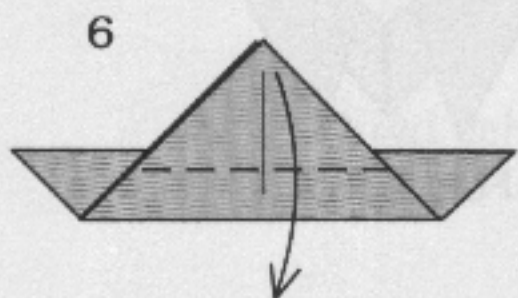

Fold one layer down.

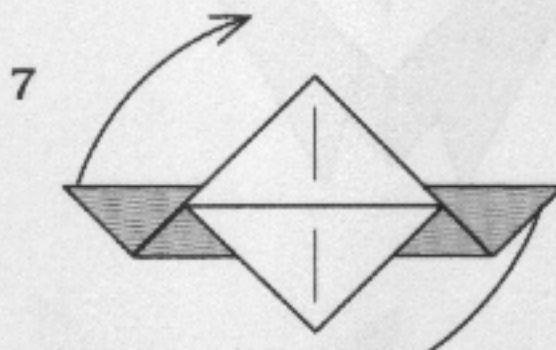

Rotate.

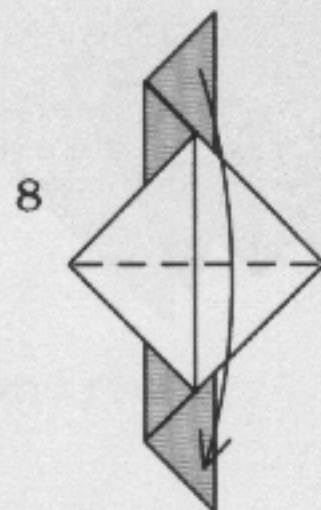

Fold in half.

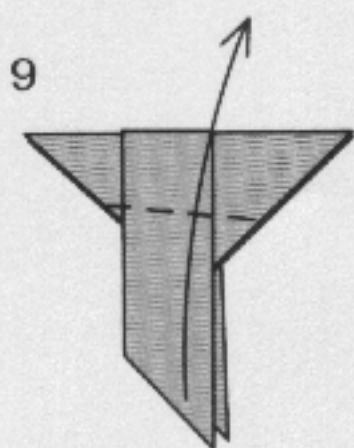

Fold the wing up,  
repeat behind.

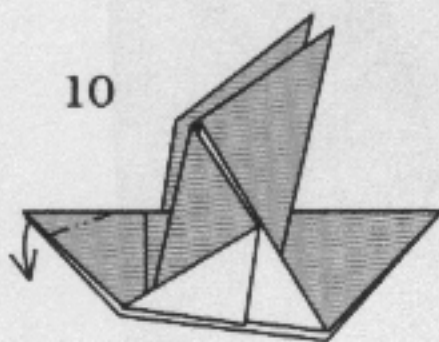

Fold the beak.

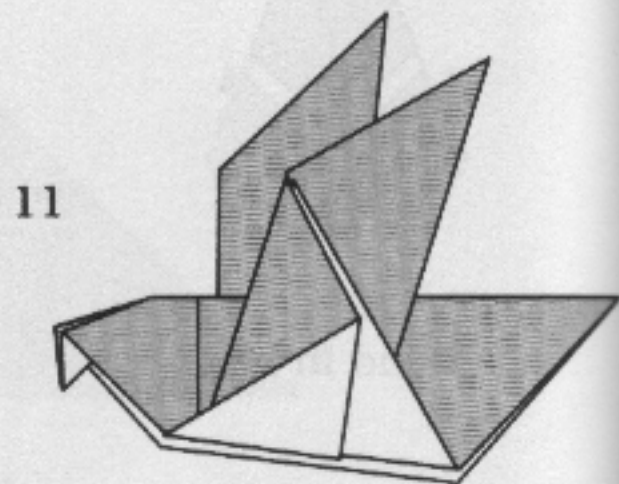

Pigeon

# Pelican

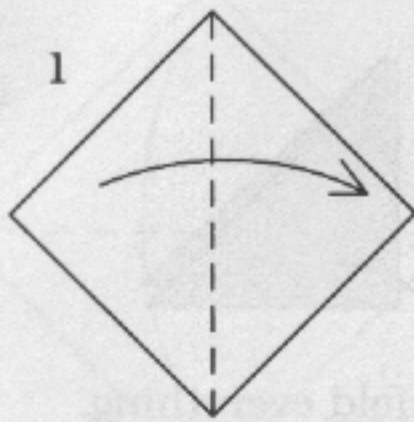

1  
Fold in half.

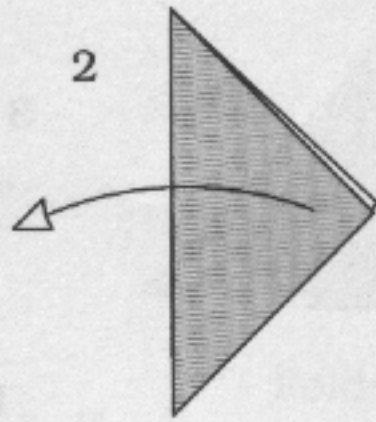

2  
Unfold.

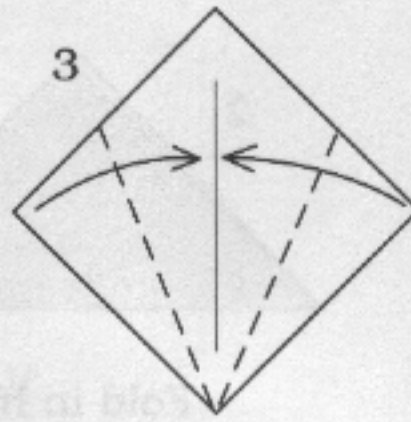

3  
Fold to the center.

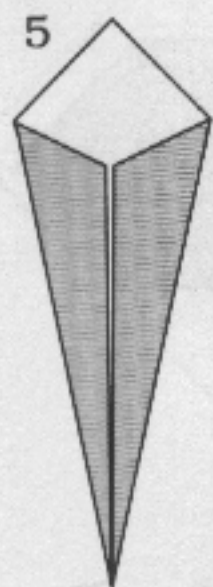
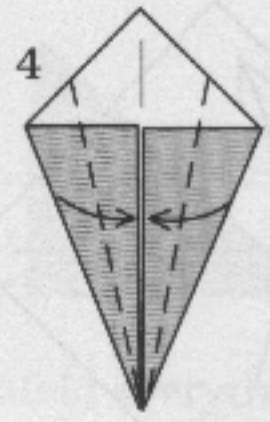

Turn over.

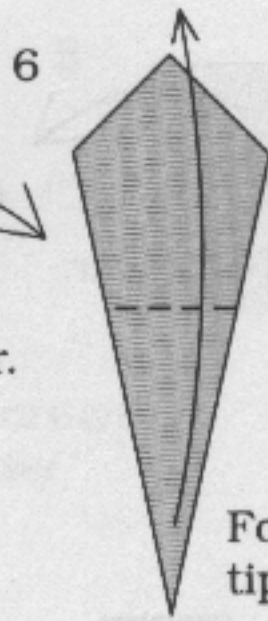

6  
Fold the bottom tip above the top.

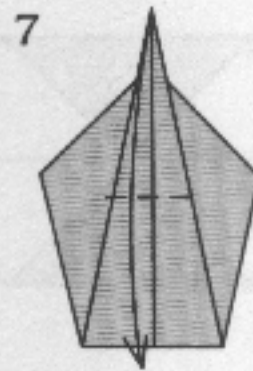

8  
Fold in half and rotate.

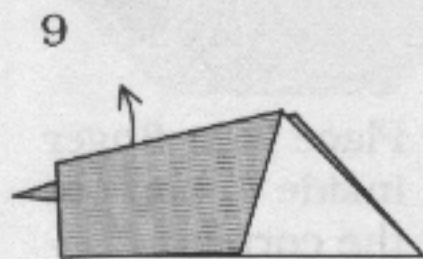

9  
Slide out the neck and head.

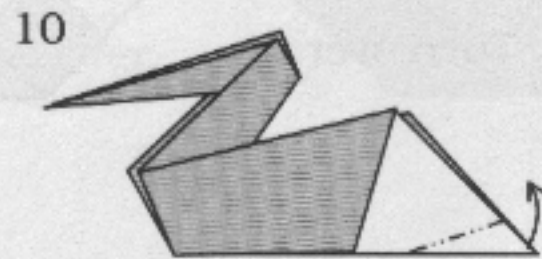

10  
Fold the tail up.

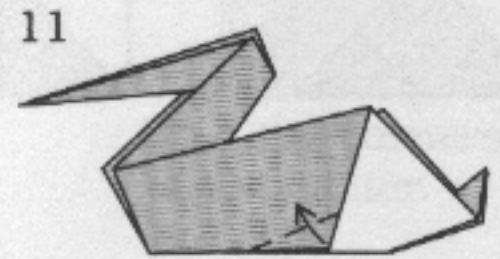

11  
Repeat behind.

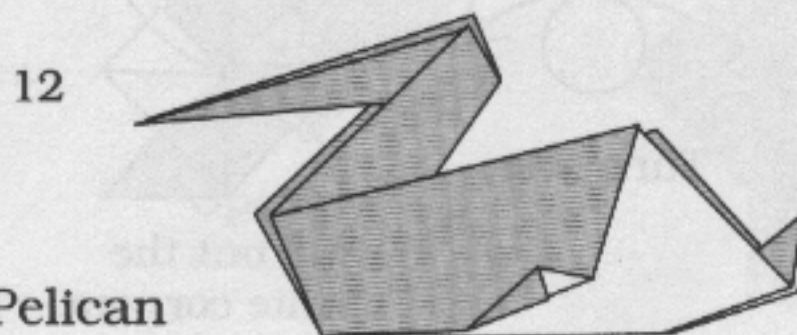

12  
Pelican

# Pin Wheel

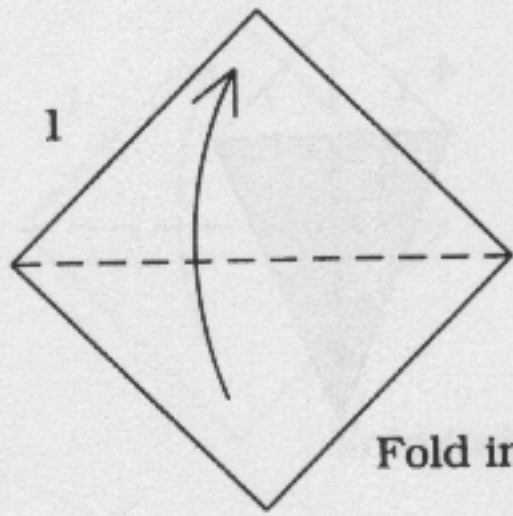

1

Fold in half.

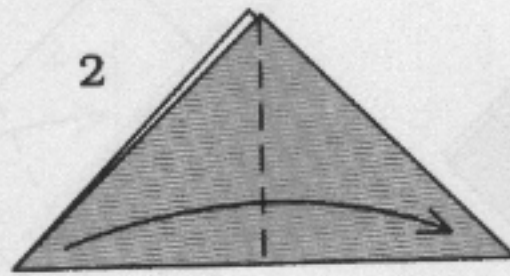

2

Fold in half.

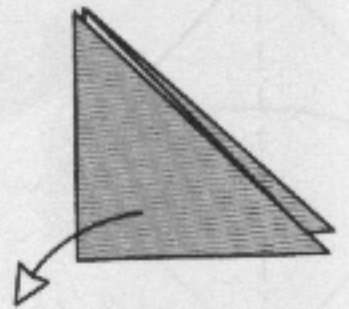

3

Unfold everything.

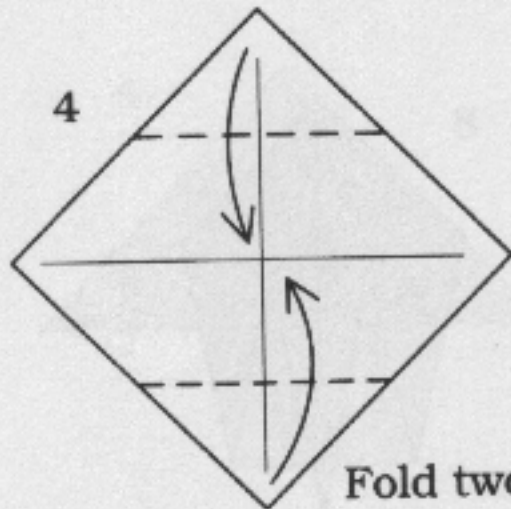

4

Fold two corners to the center.

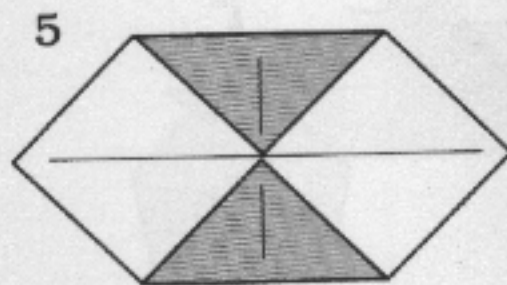

5



Turn over.

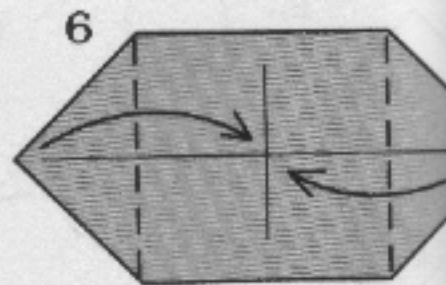

6

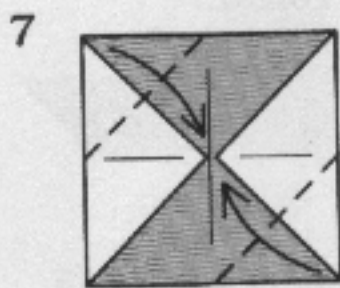

7

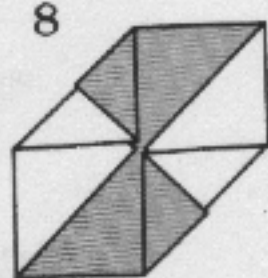

8



Turn over.

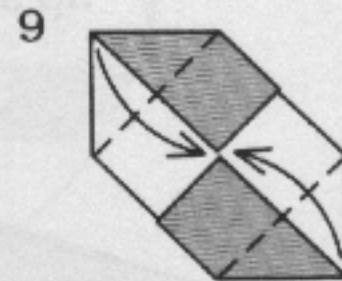

9

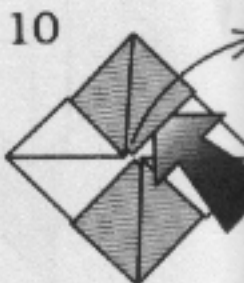

10

Place your finger inside to pop the corner.

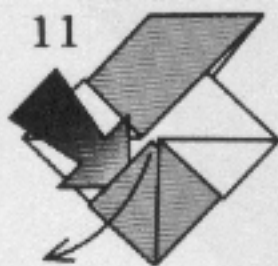

11

Pop out the lower corner.

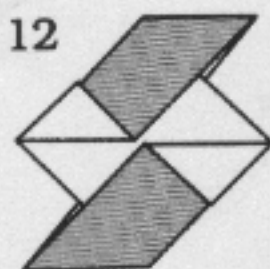

12



Turn over.

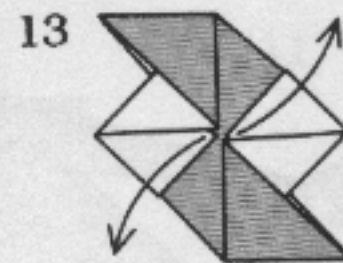

13

Pull out the white corners.

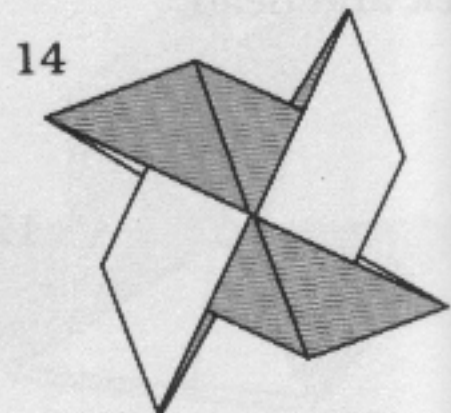

14

Pin Wheel

# Lantern

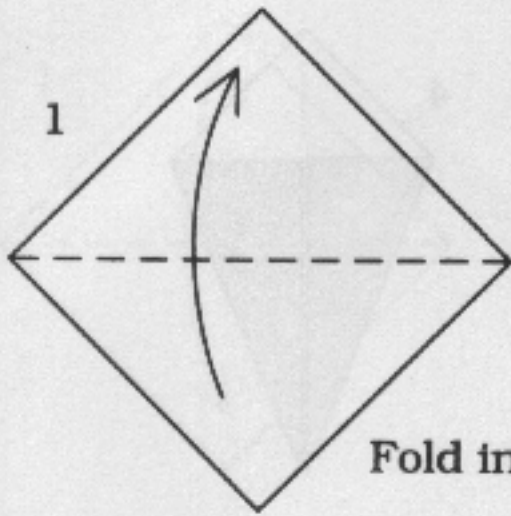

Fold in half.

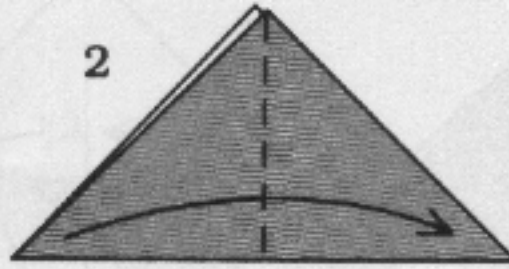

Fold in half.

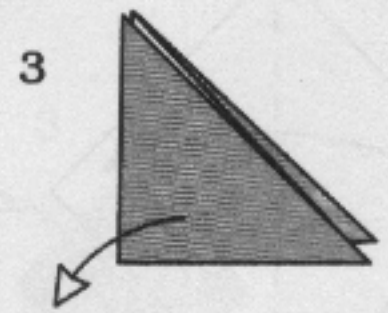

Unfold everything.

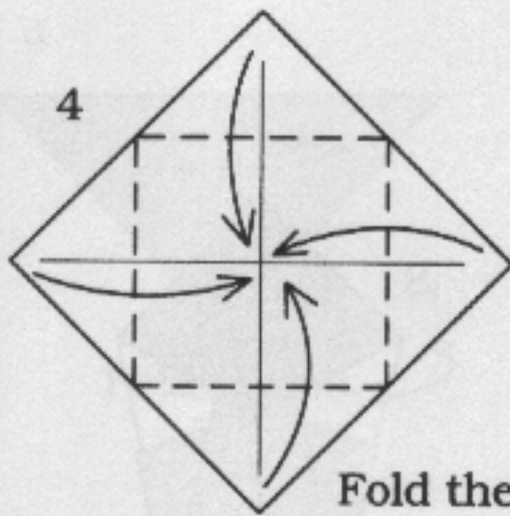

Fold the corners to the center.

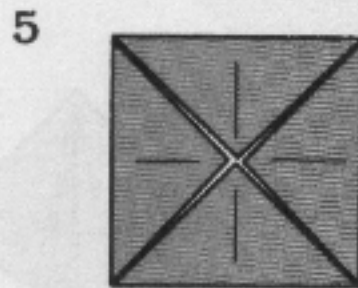

Turn over and rotate.

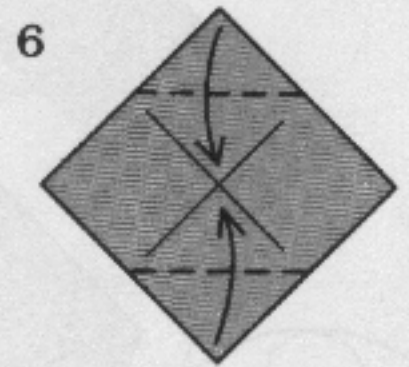

Fold the top and bottom to the center.

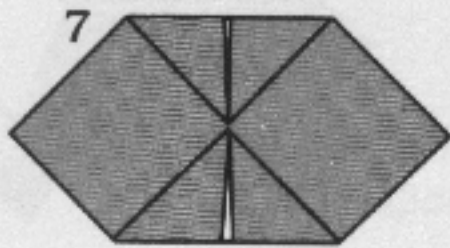

Turn over.

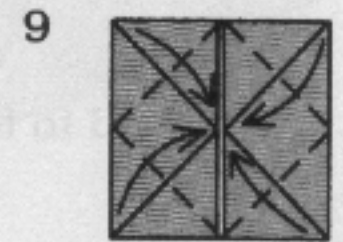
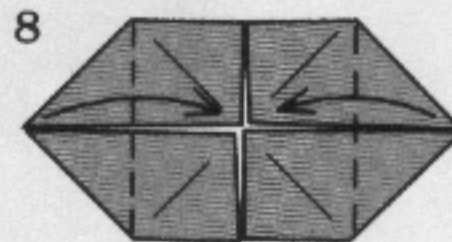

Fold the corners to the center.

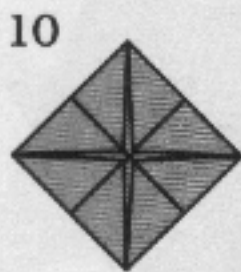

Turn over.

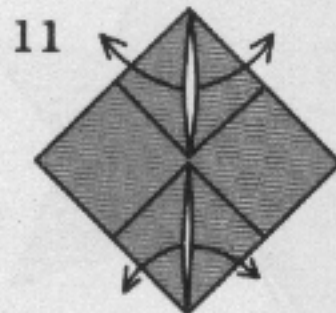

Open the top and bottom.

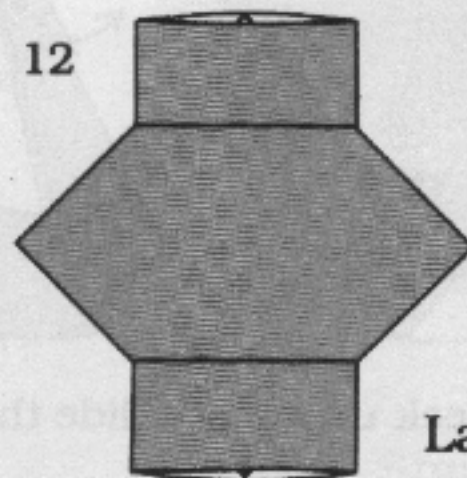

Lantern

# Swan

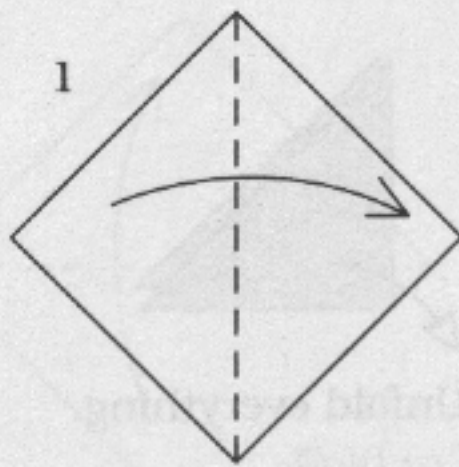

1  
Fold in half.

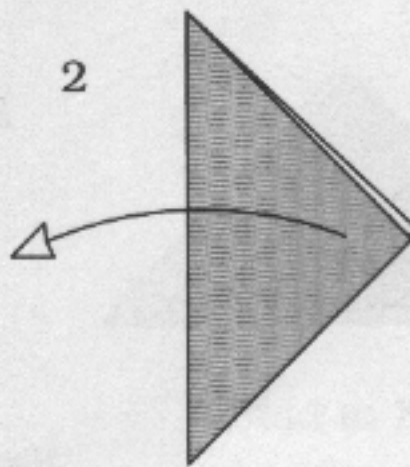

2  
Unfold.

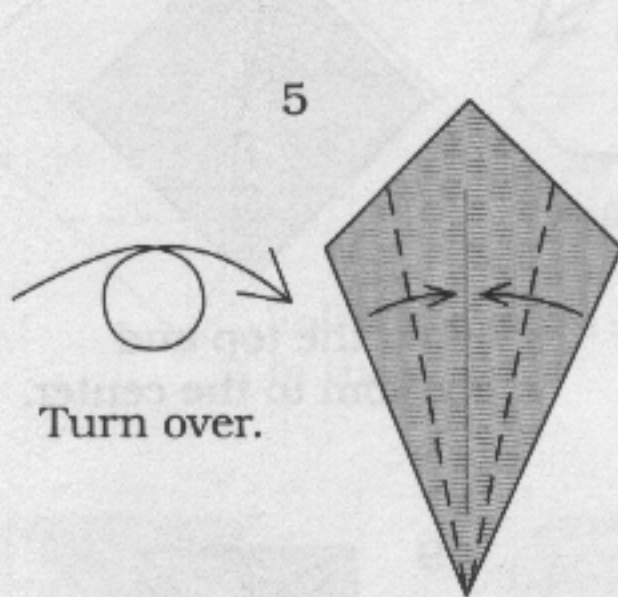
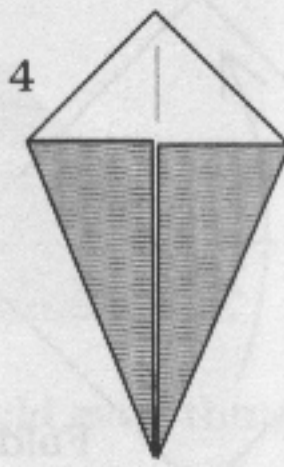
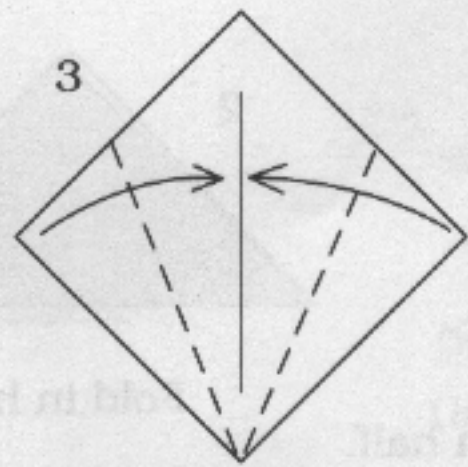

5  
Turn over.

Fold to the center.

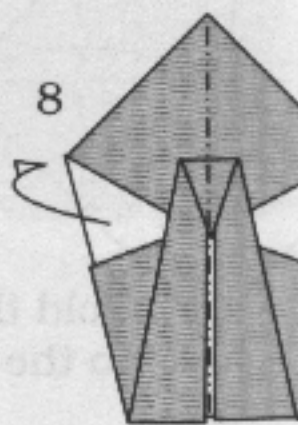
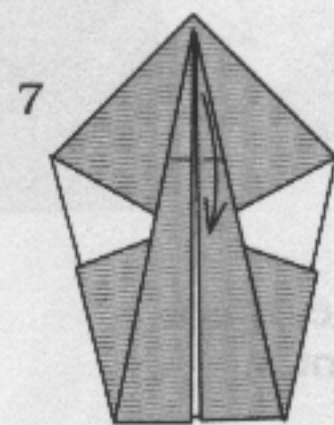
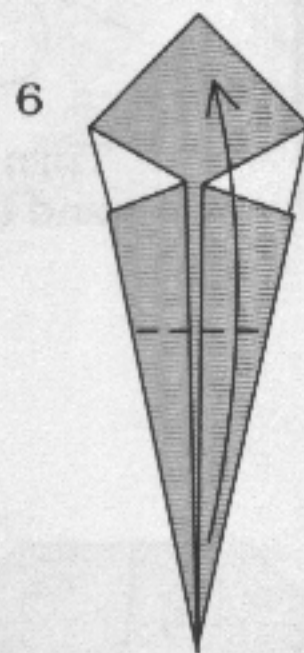

8  
Fold behind

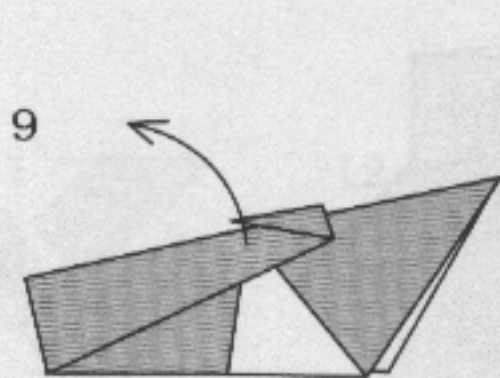

9  
Slide the neck up.

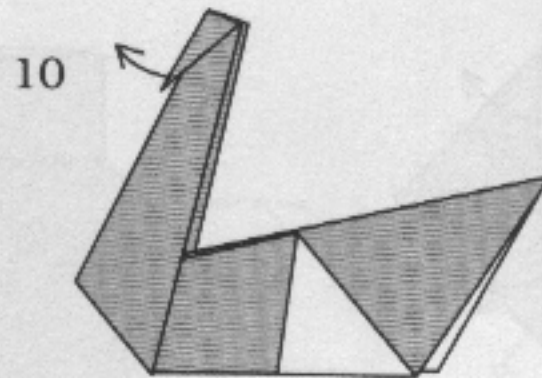

10  
Slide the head up.

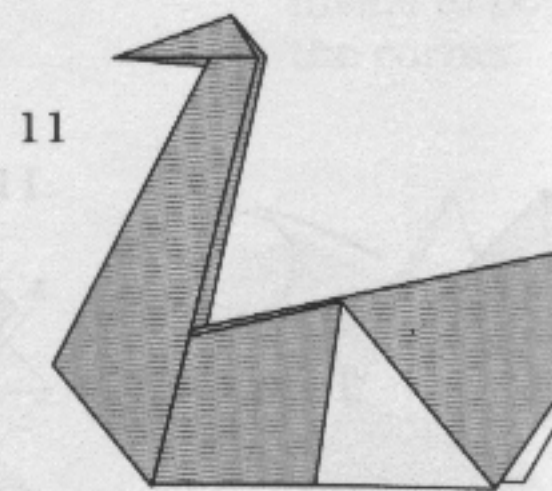

11  
Swan

# Star

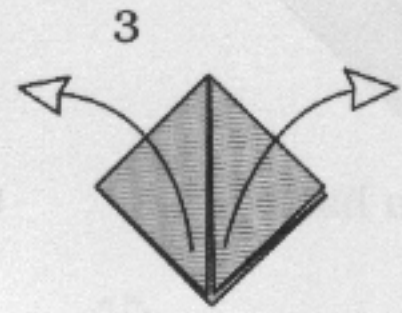
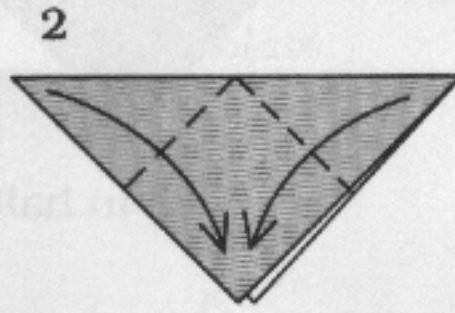
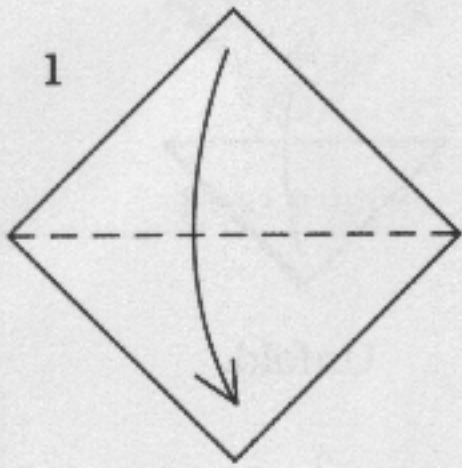

Unfold.

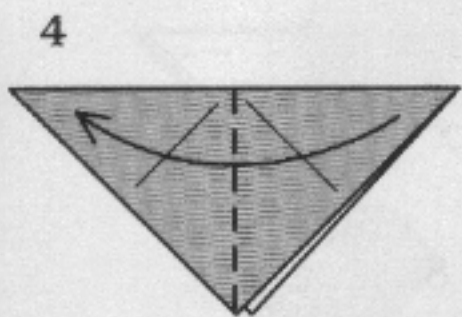

Fold in half.

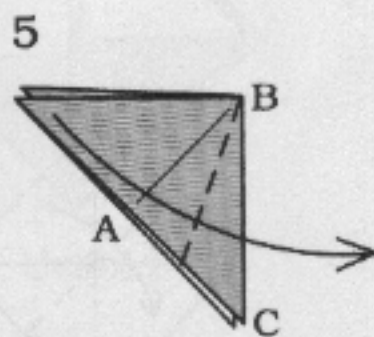

Fold A to the line B-C.

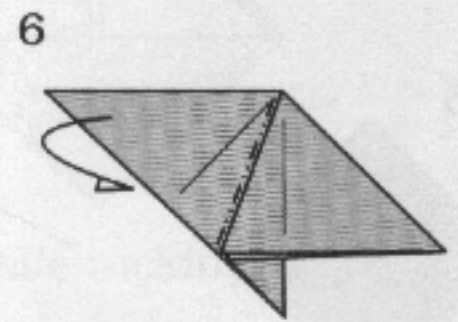

Fold behind.

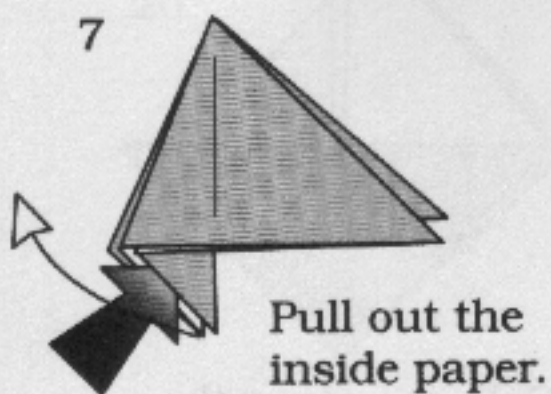

Pull out the inside paper.

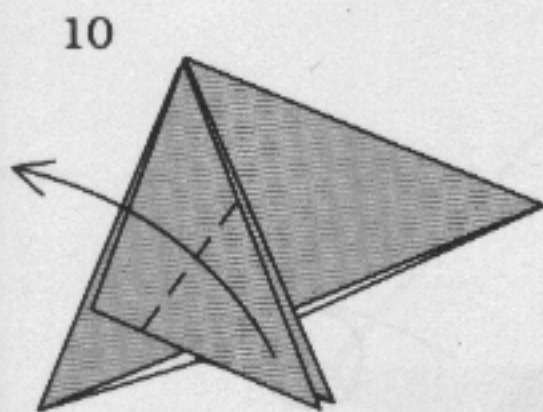
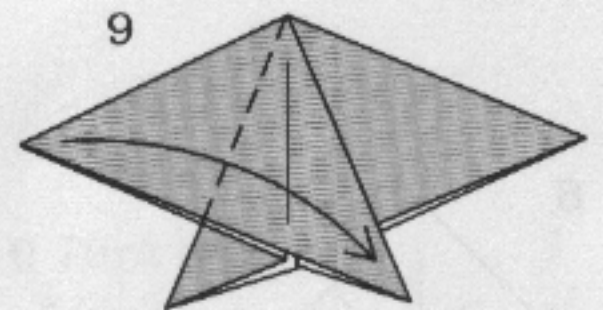
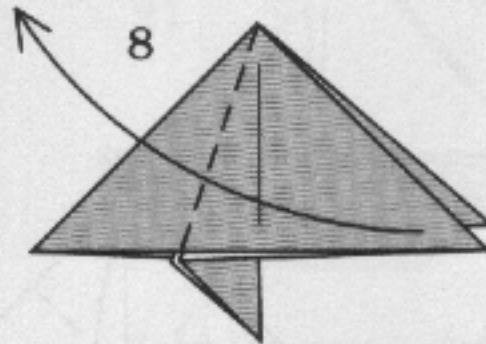

There are no guide lines for this fold.

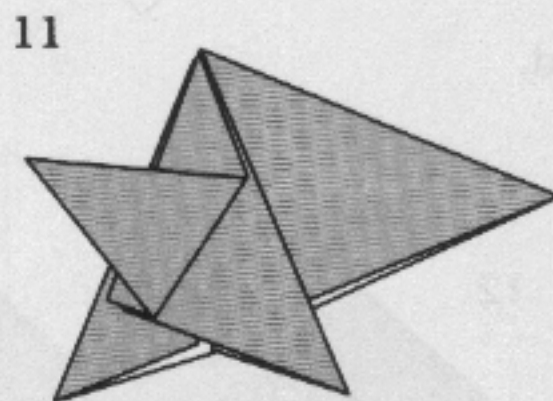

Repeat steps 9 and 10 behind.

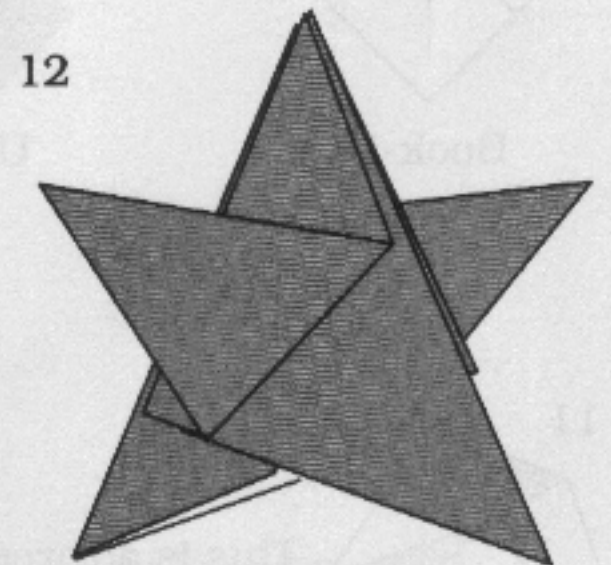

Star

# Sailboat

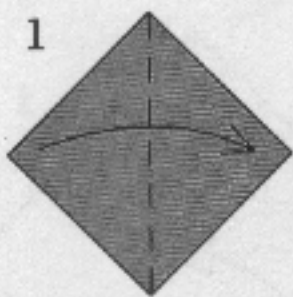

1  
Fold in half.

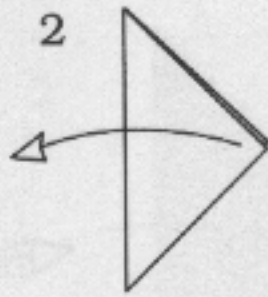

2  
Unfold.

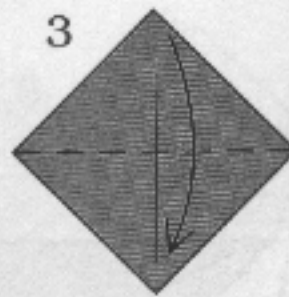

3  
Fold in half.

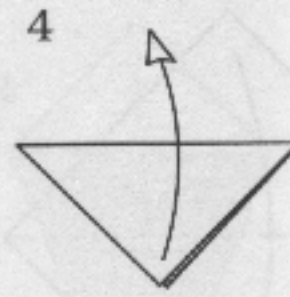

4  
Unfold.

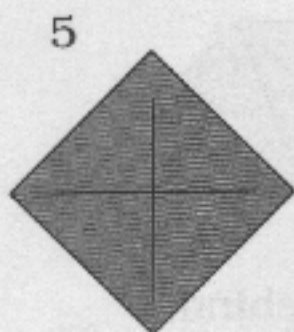

5



Turn over.

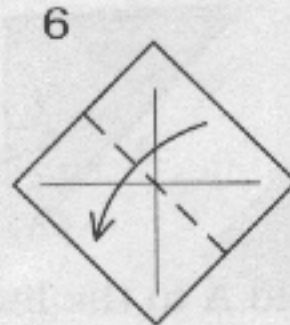

6  
Book-fold.



7  
Unfold.

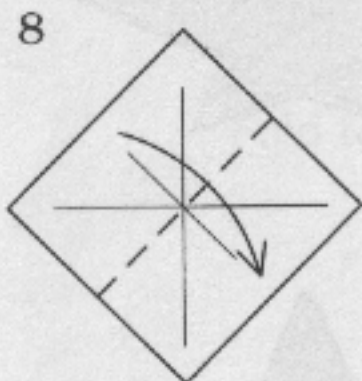

8  
Book-fold.

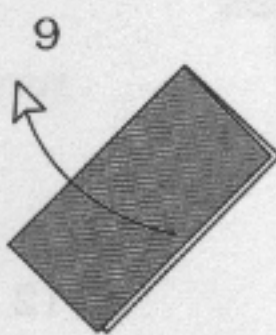

9  
Unfold.

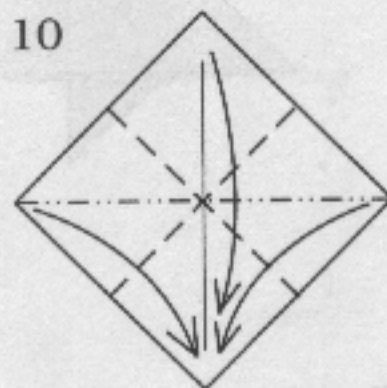

10

Collapse along the creases so that all the corners meet.

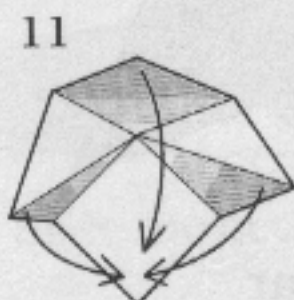

11

This is a three-dimensional intermediate step.

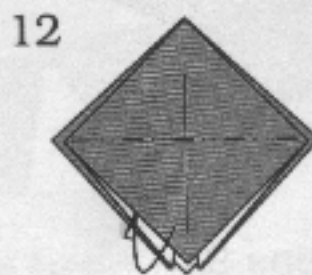

12  
Fold inside.

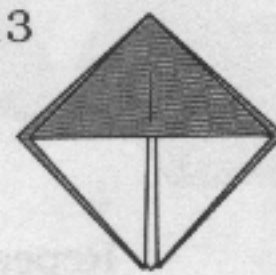

13



Turn over.

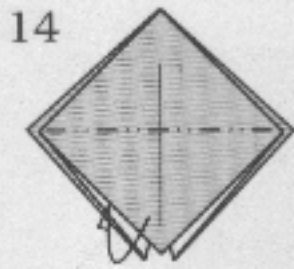

Fold inside.

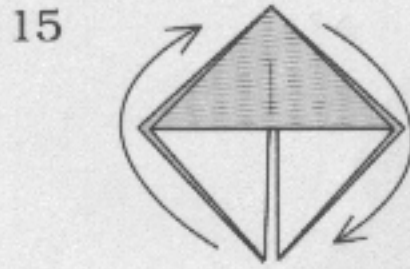

Rotate.

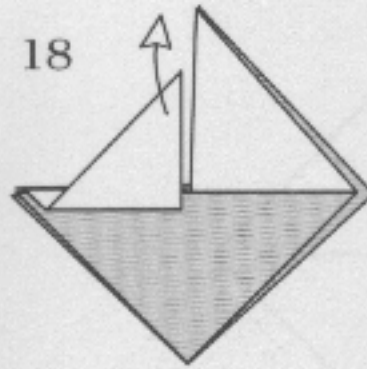
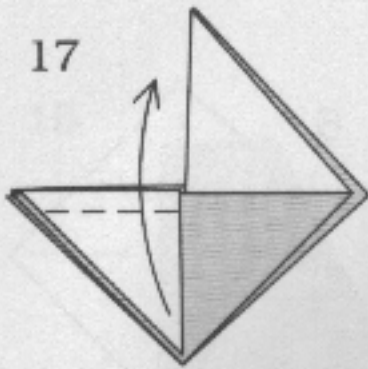
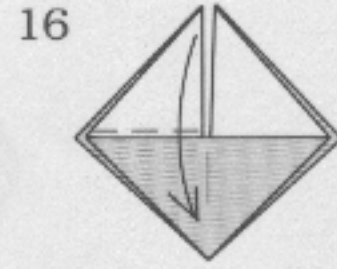

Unfold.

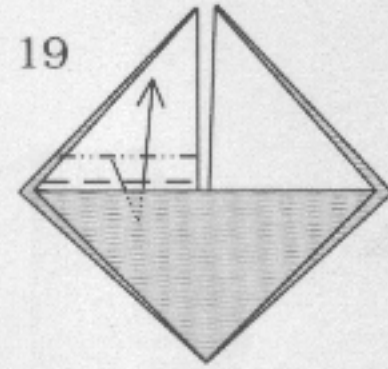

Refold while tucking inside.

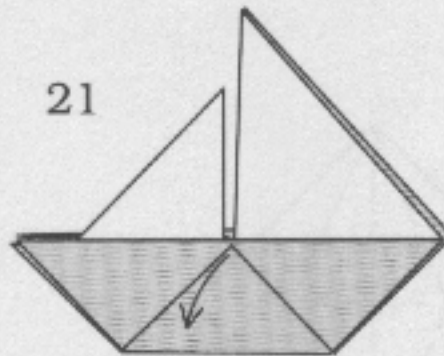
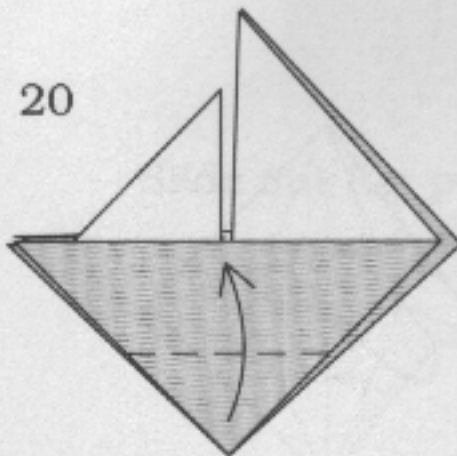

Fold the triangle  
down a little so the  
sailboat can stand.



Turn over.

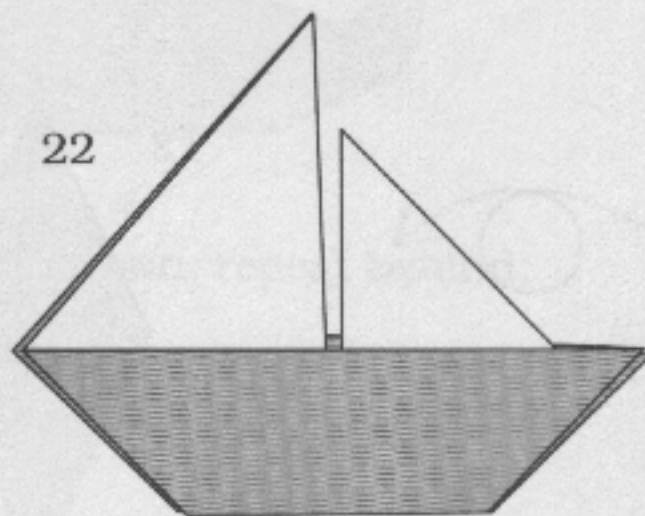

Sailboat

This sailboat is the logo for  
*The Friends of The Origami  
Center of America.*

# Carp

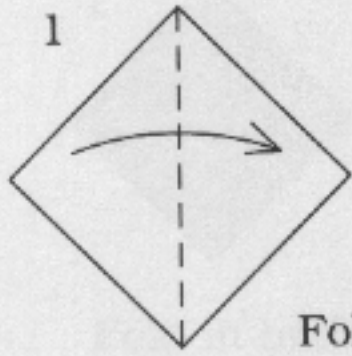

Fold in half.

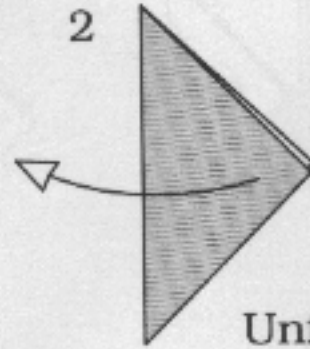

Unfold.

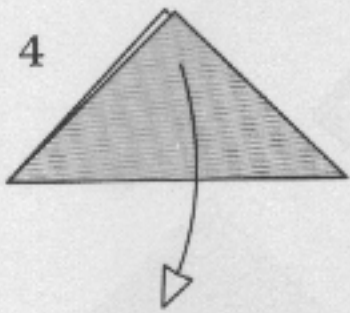
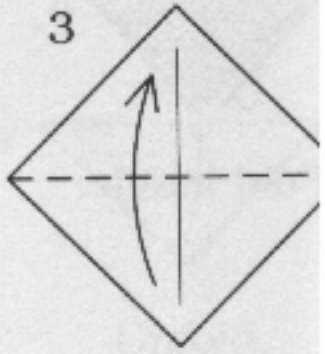

Unfold.

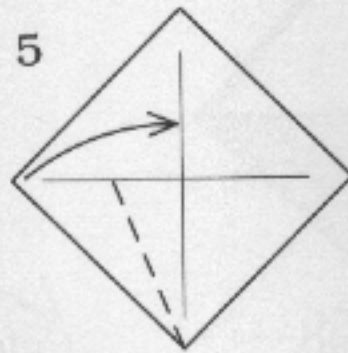

Kite-fold but only crease below the center line.

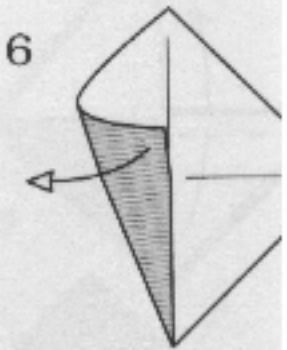

Unfold

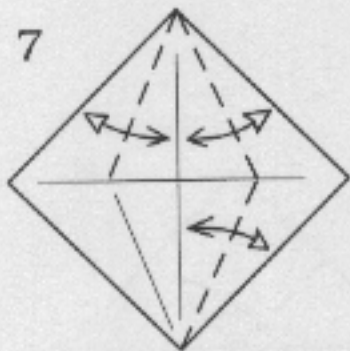

Fold and unfold three other sides.

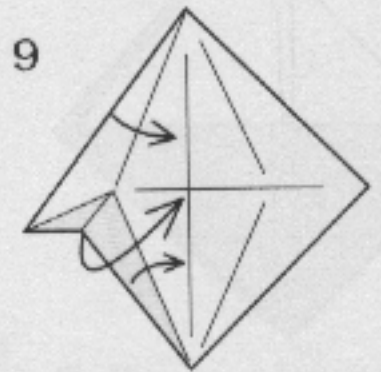
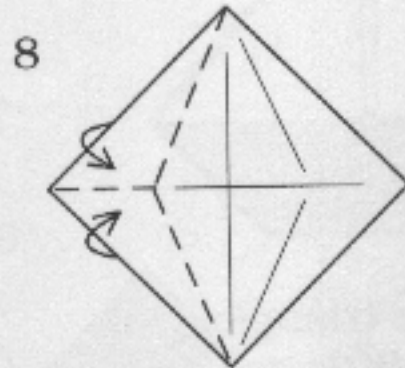

This is a three-dimensional drawing.

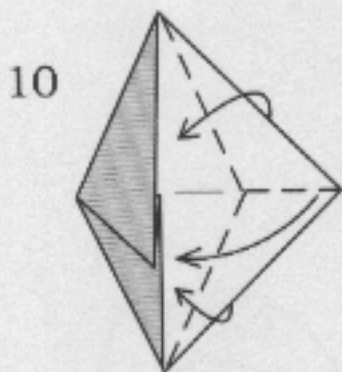

Repeat steps 8 and 9 on the right.

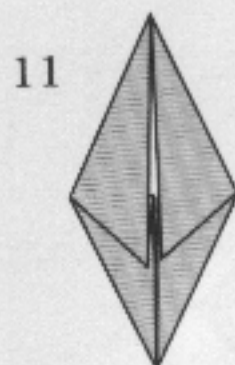

Turn over.

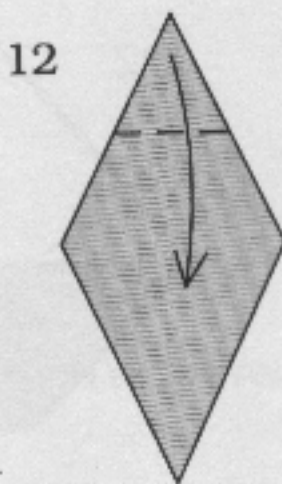

13

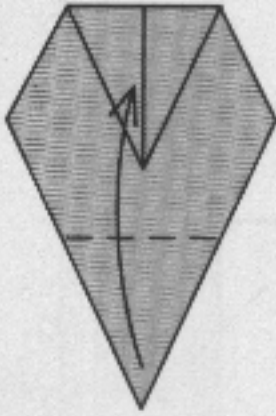

14

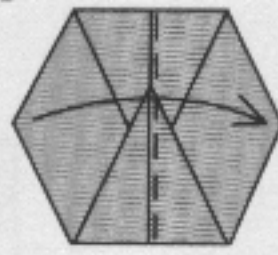

15

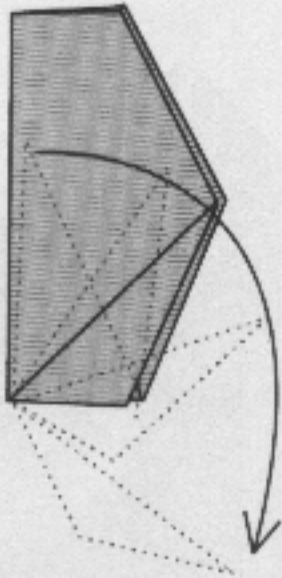

Slide out the point.

16

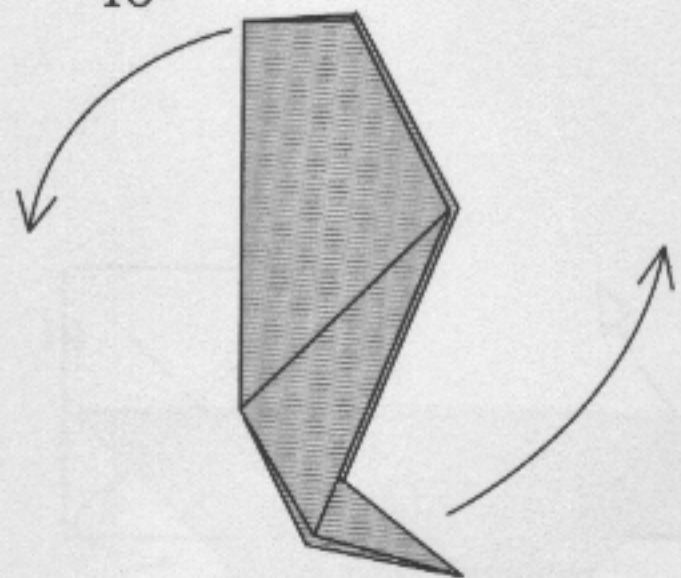

Rotate.

17

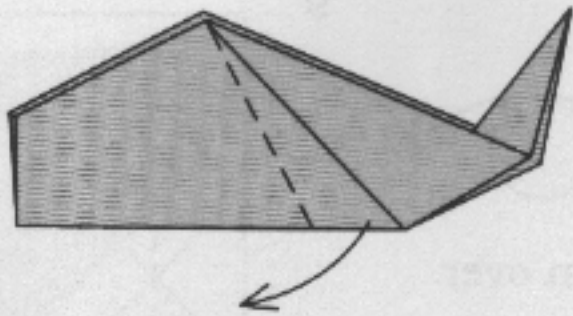

Fold the fin down, repeat behind.

18

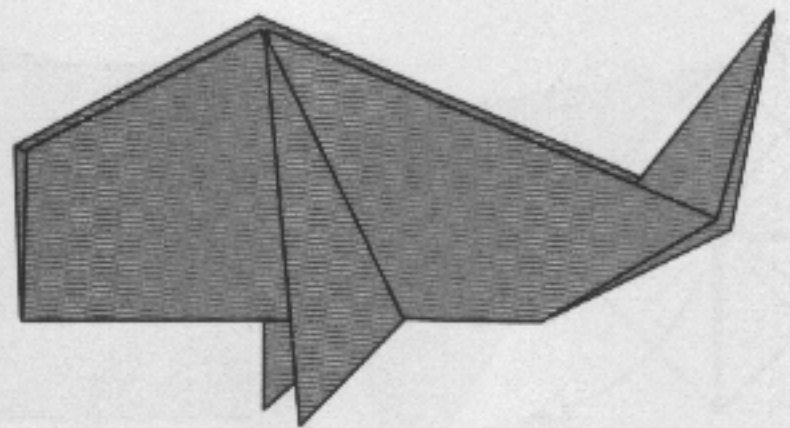

Carp

# Butterfly

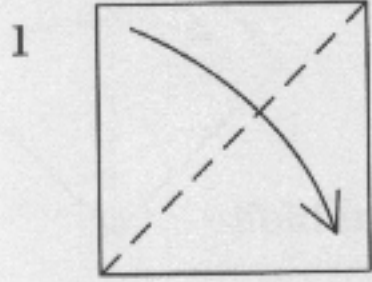

Fold in half.

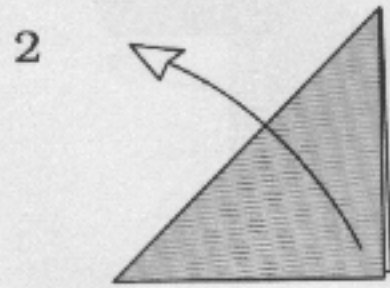

Unfold.

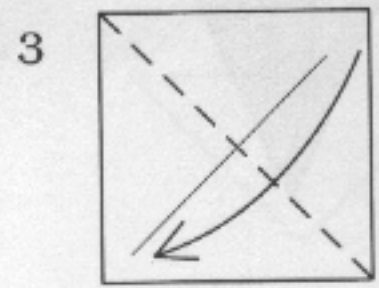

Fold in half.

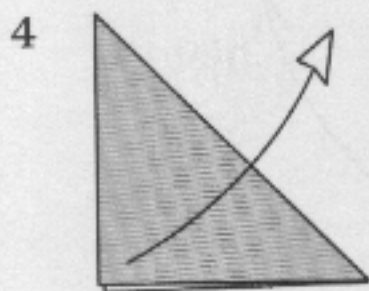

Unfold.

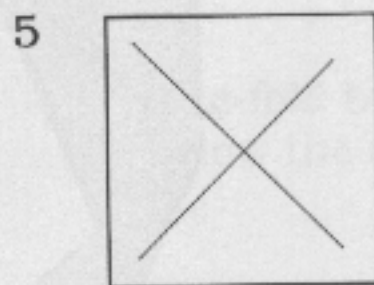

Turn over.

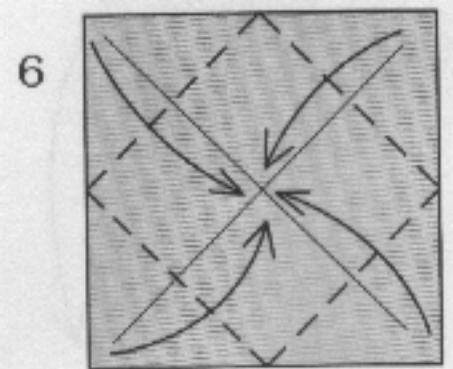

Fold the corners to the center.

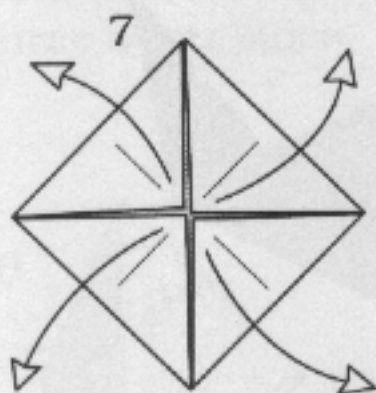

Unfold.

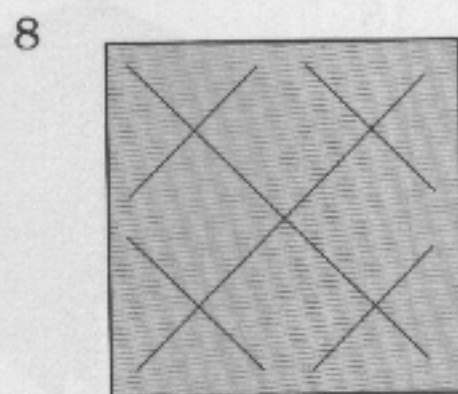

Turn over.

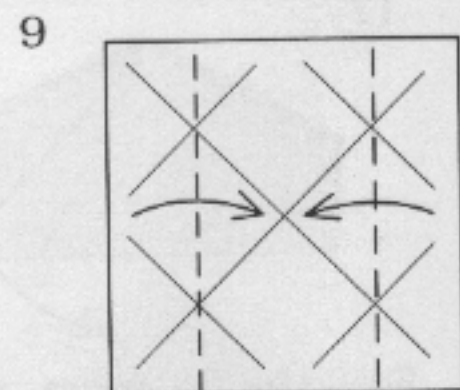

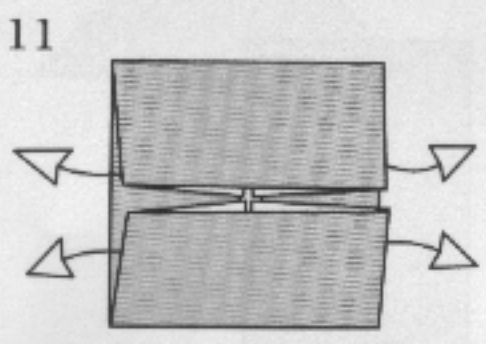
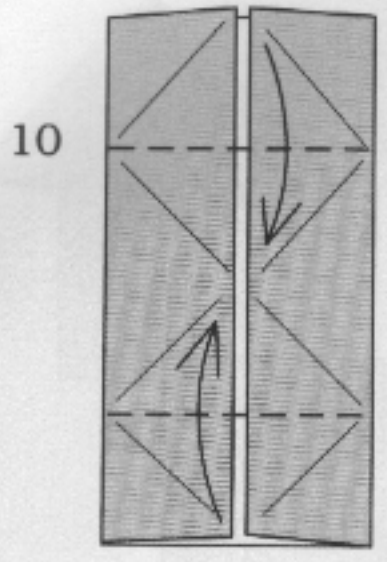

Pull out the corners.

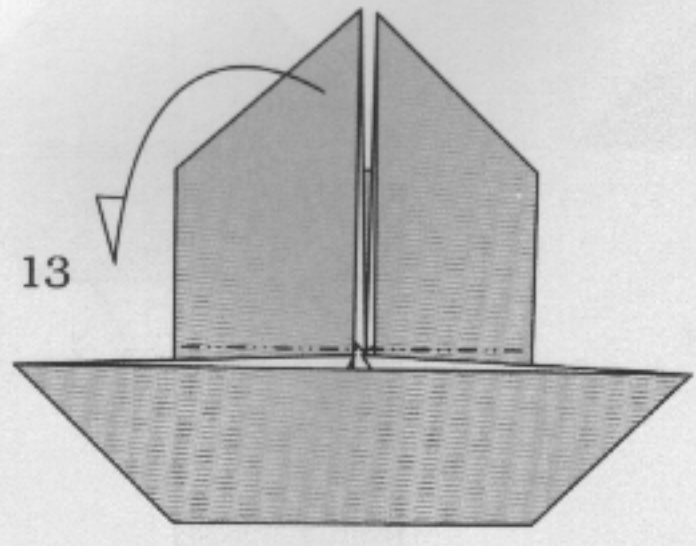
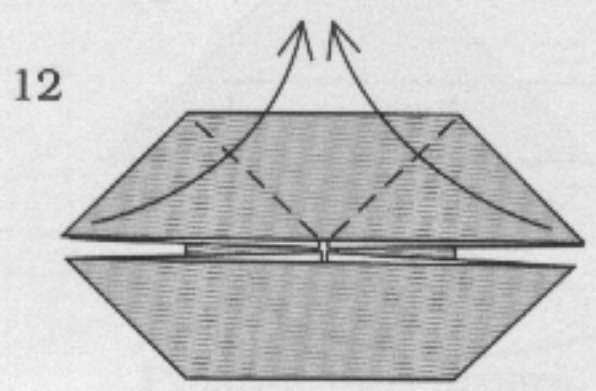

Fold behind.

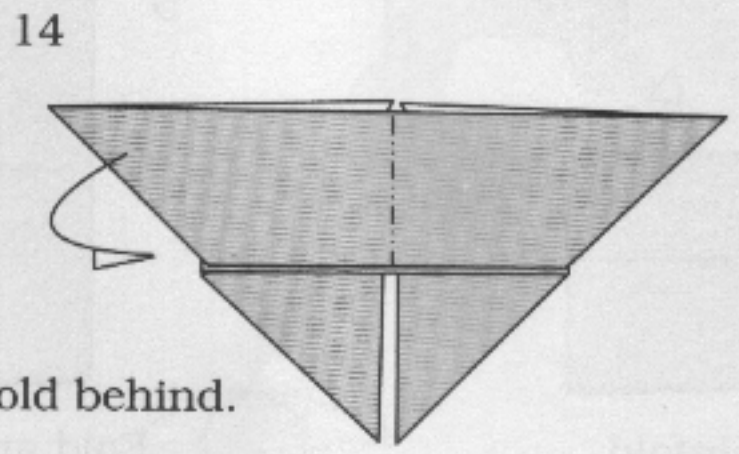

Fold behind.

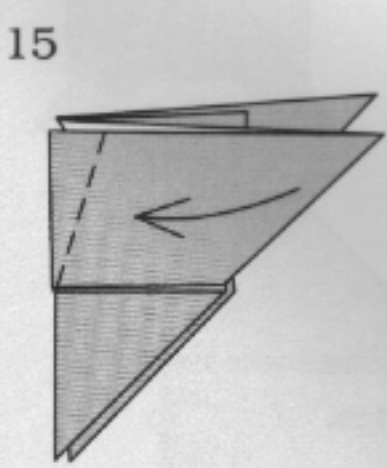

Repeat behind.

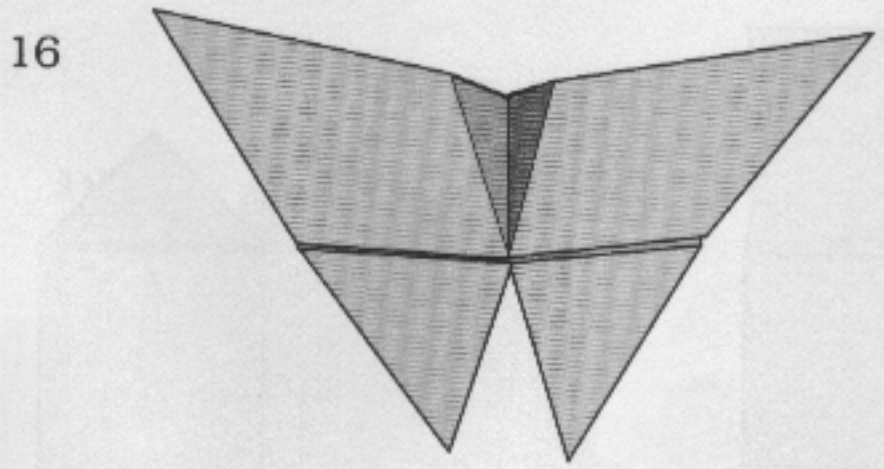

Butterfly

# Frog

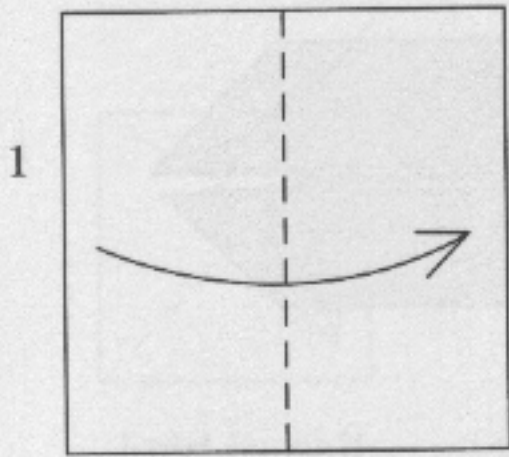

Fold in half.

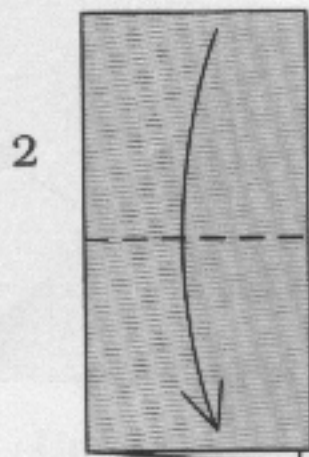

Fold in half.

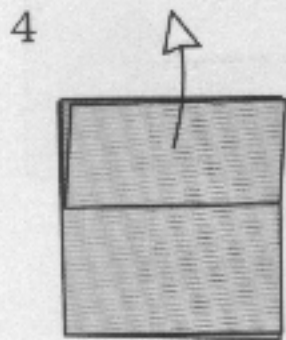
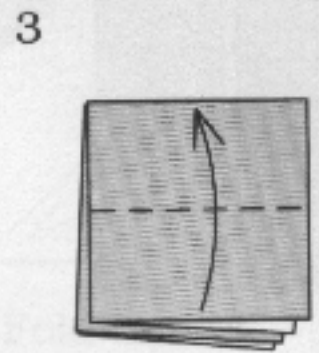

Unfold.

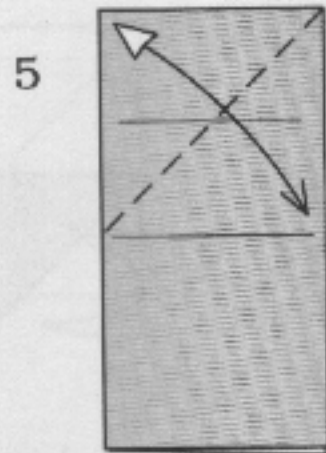

Fold and unfold.

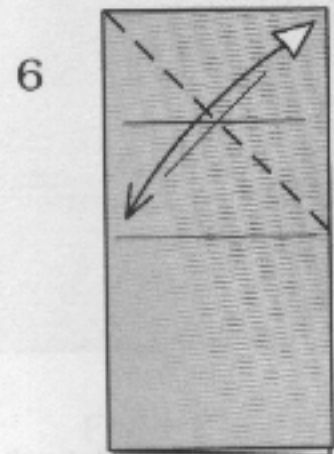

Fold and unfold.

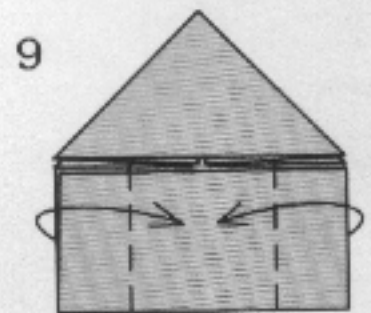
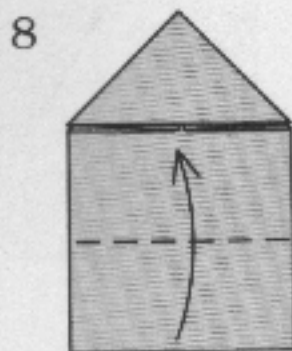
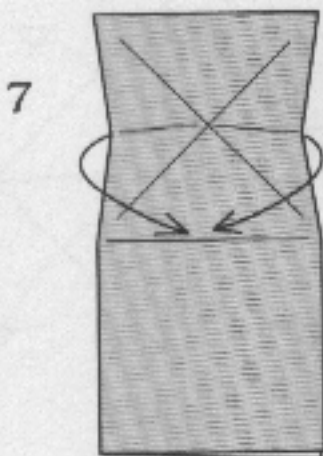

10

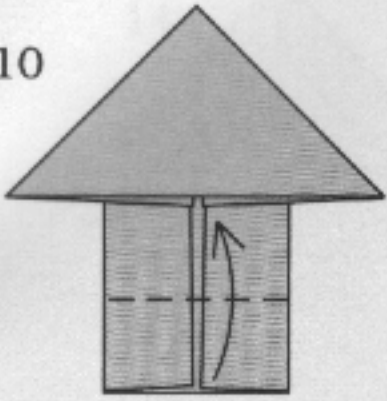

11

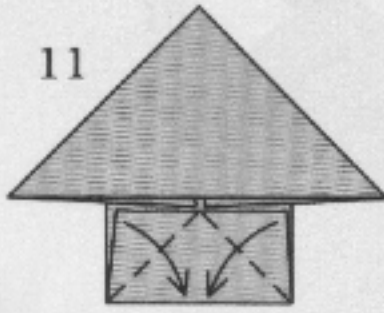

12

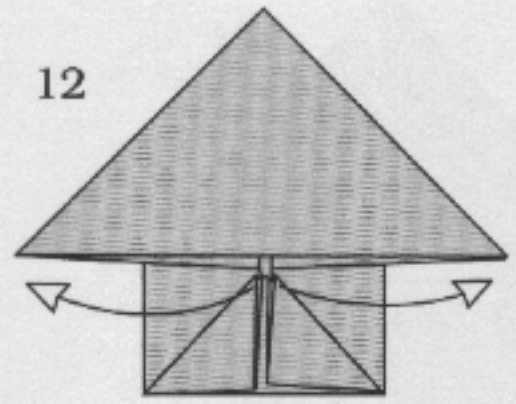

Pull out the corners.

13

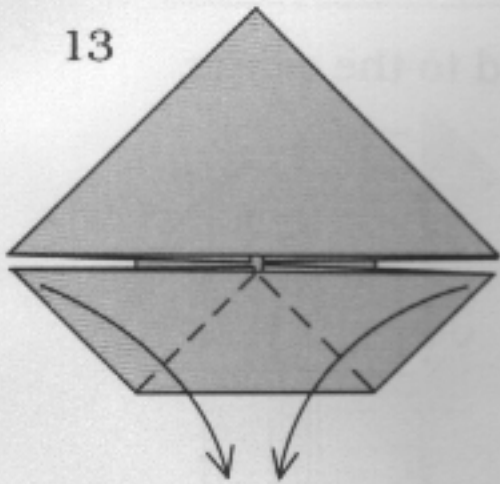

14

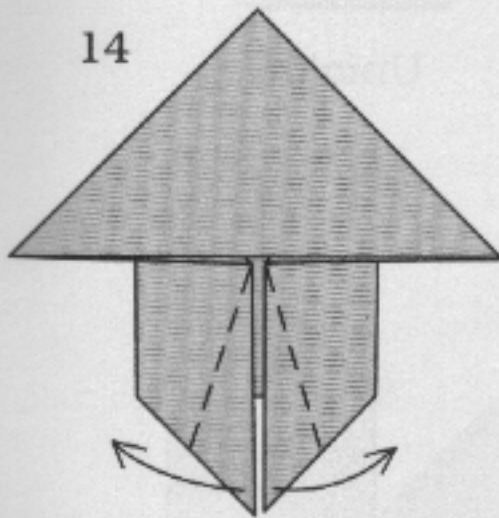

15

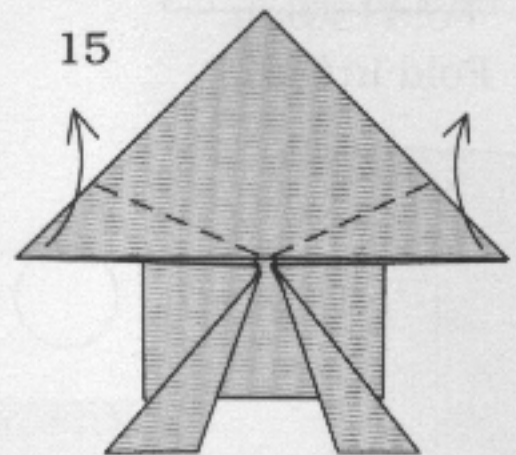

16

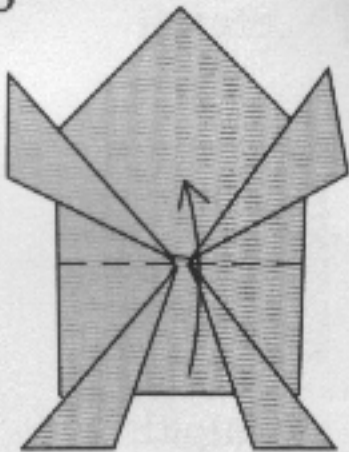

17

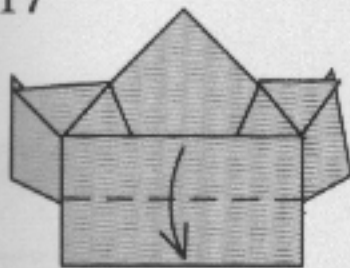

Turn over.

18

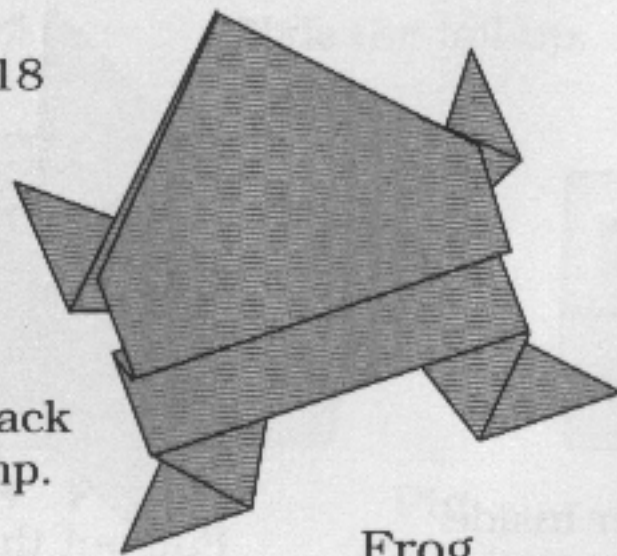

Push down on the back and the frog will jump.

Frog

# Pig

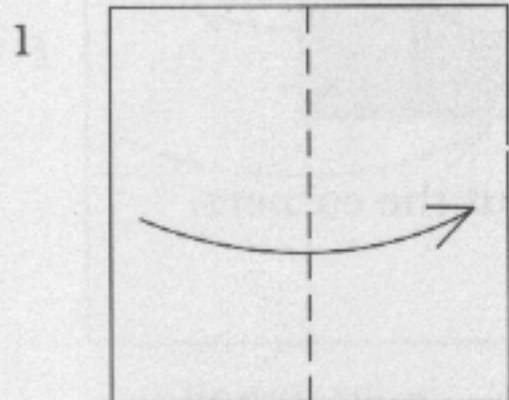

Fold in half.

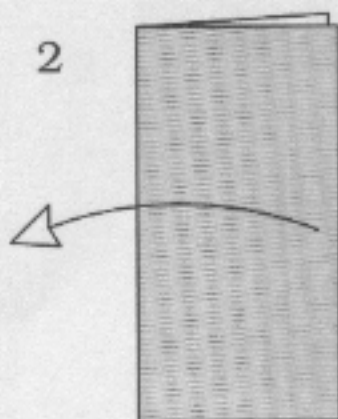

Unfold.

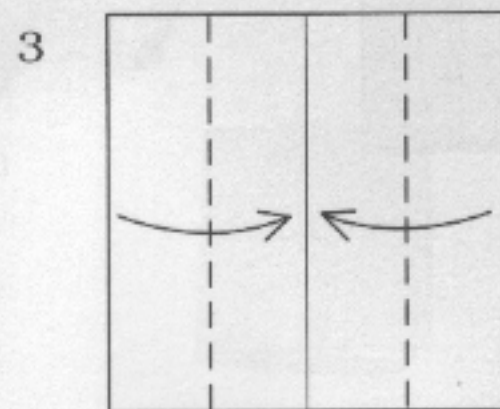

Fold to the center.

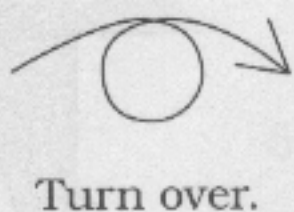
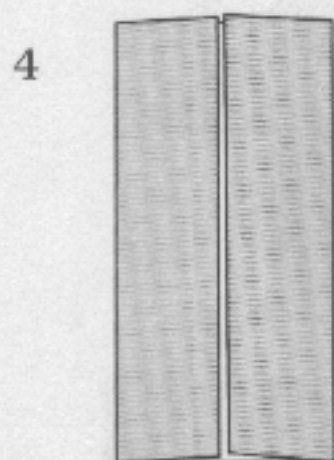

Turn over.

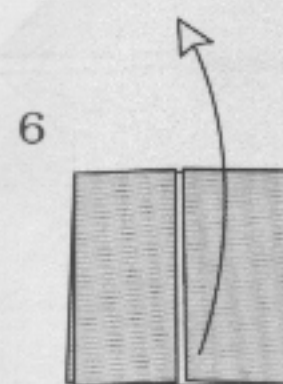
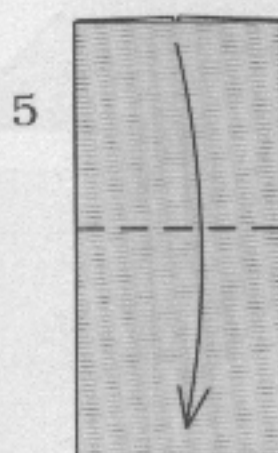

Unfold.

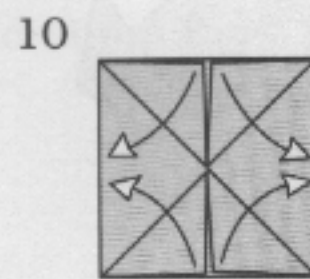
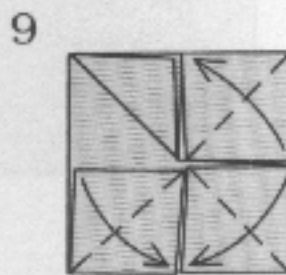
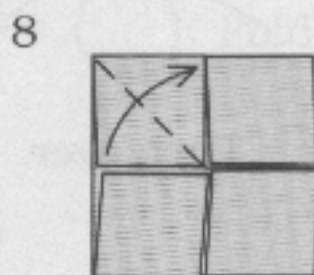
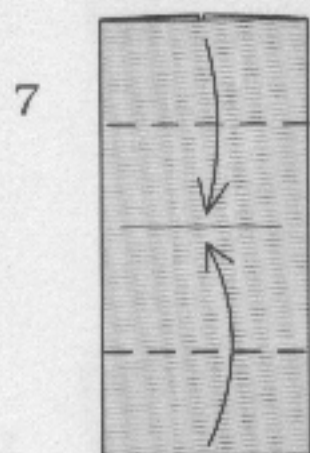

Unfold.

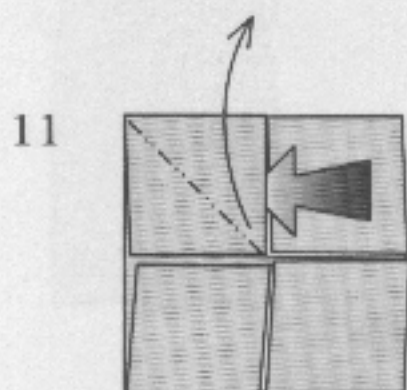

Place your finger inside to pull out the corner.

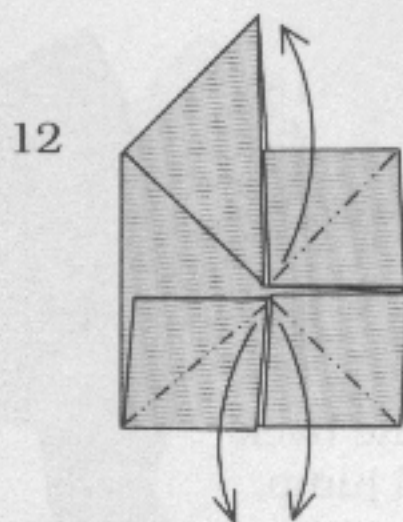

Pull out the three other corners.

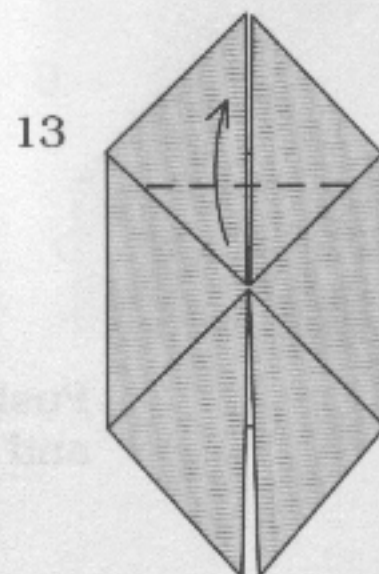

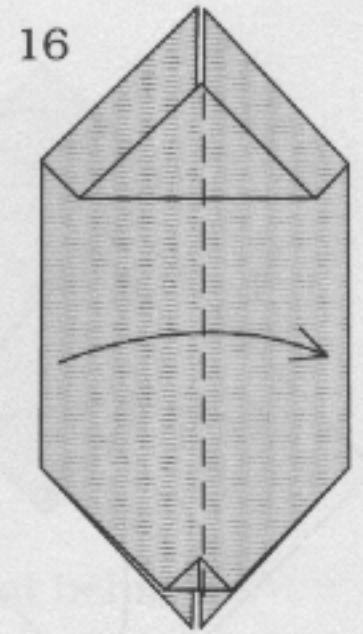
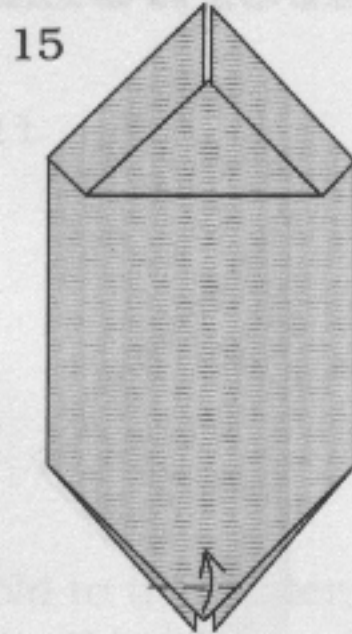
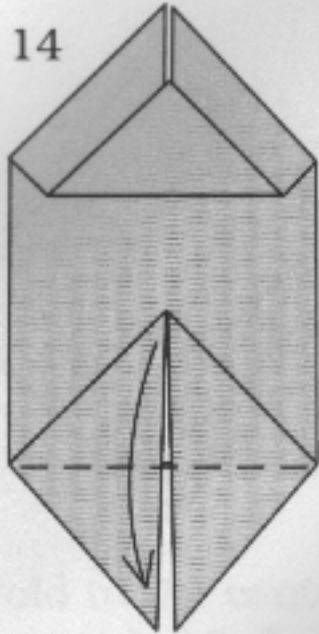

Fold in half.

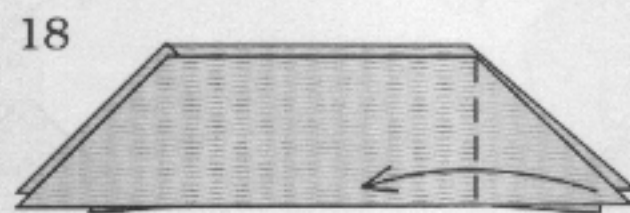
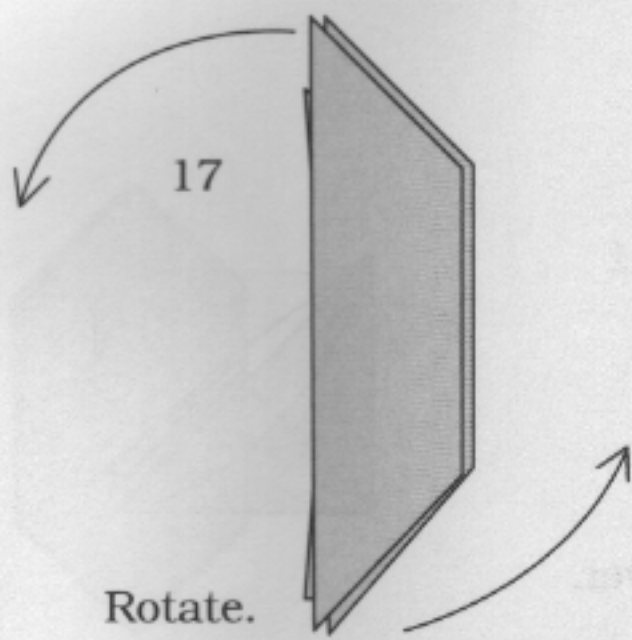

Repeat behind.

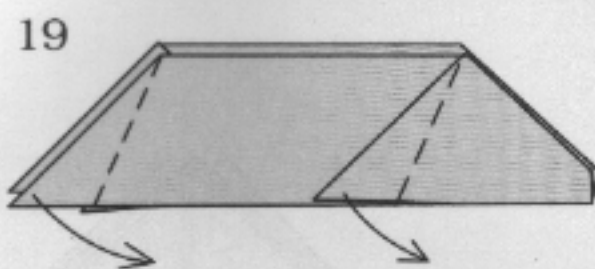

Fold the legs down,  
repeat behind.

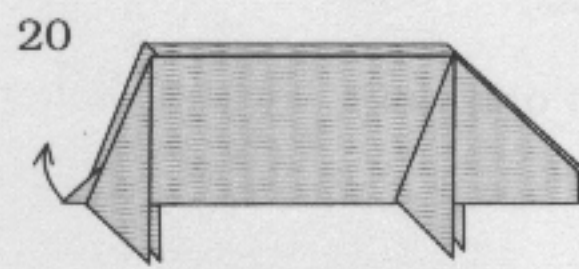

Slide the tail up.

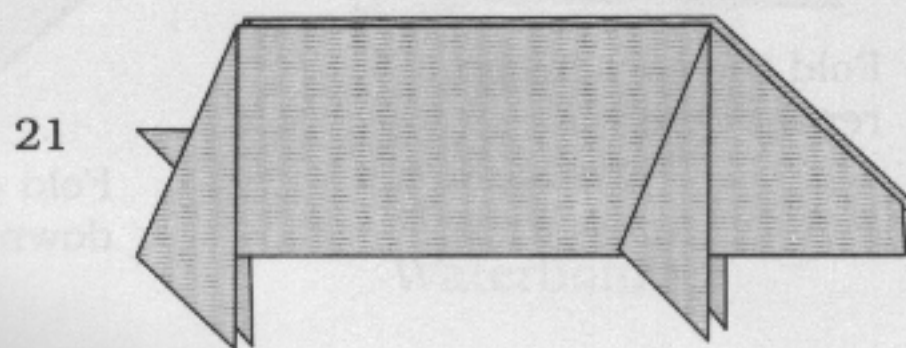

Pig

# Waterbomb

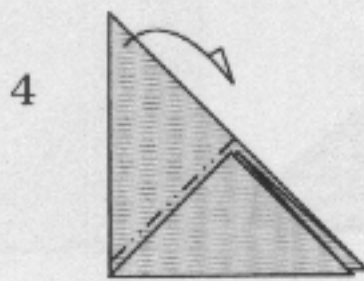
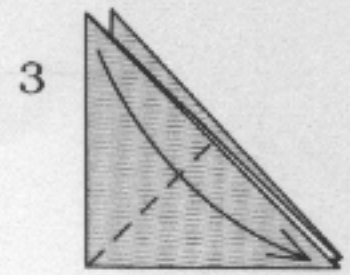
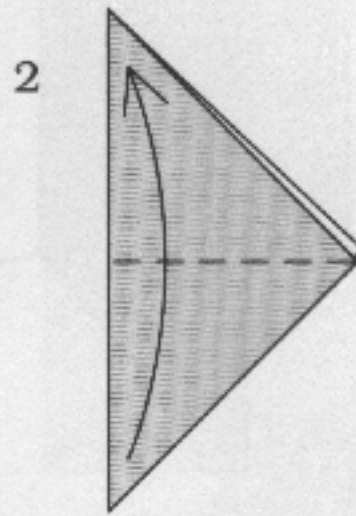
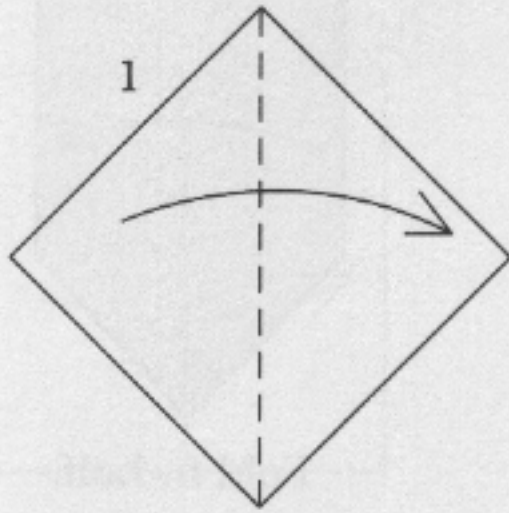

Fold behind.

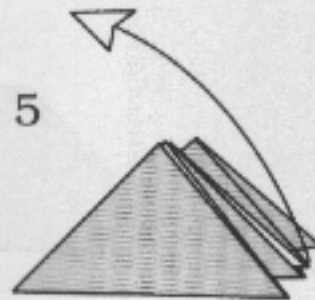

Pull out the middle layer.

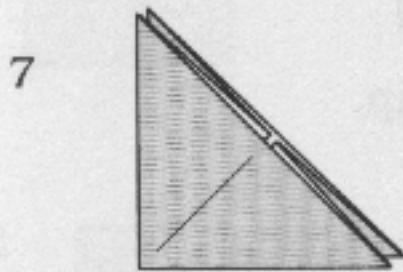
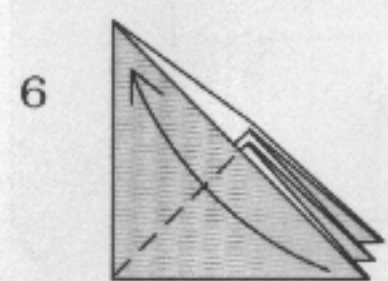

Rotate.



Fold the corners up,  
repeat behind.

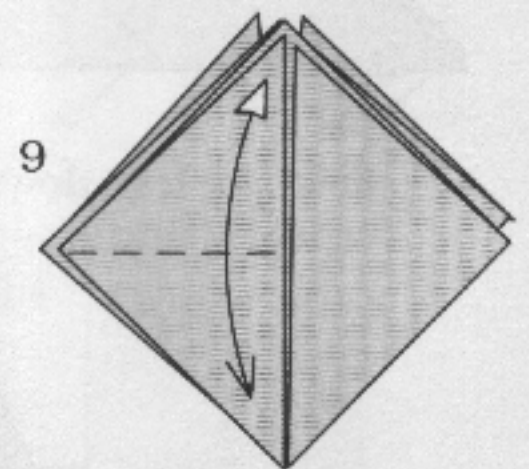

Fold one layer  
down and unfold.

10

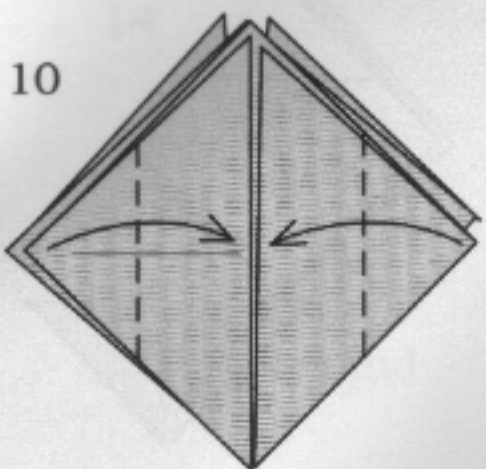

Fold to the center, repeat behind.

11

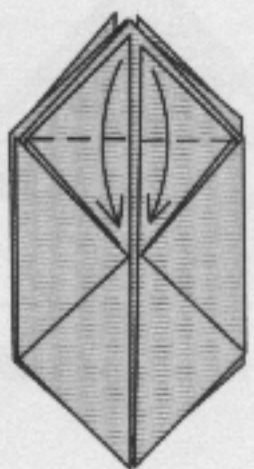

Fold to the center, repeat behind.

12

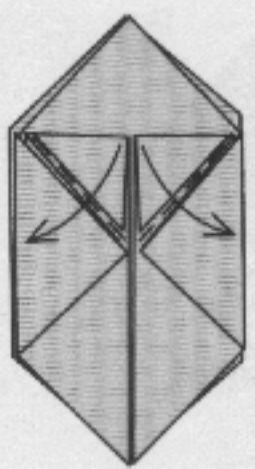

Repeat behind.

13



Unfold, repeat behind.

14

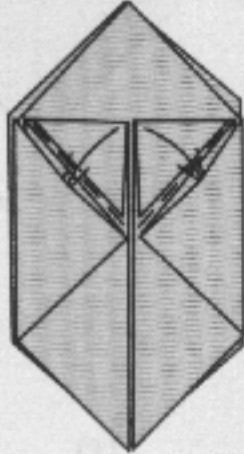

Tuck inside the pockets, repeat behind.

15



Blow into the bottom.

16

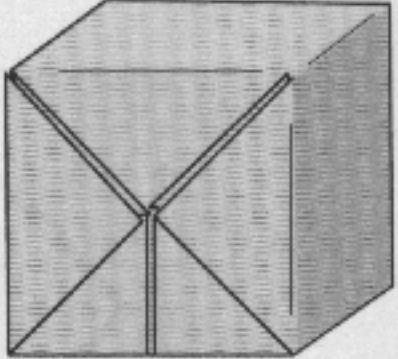

Waterbomb

# Candy Box

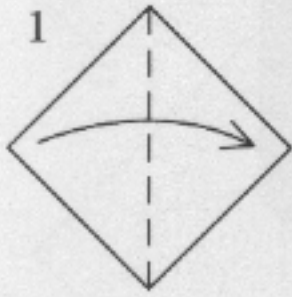

1  
Fold in half.

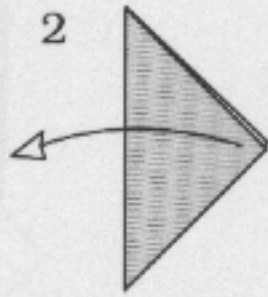

2  
Unfold.

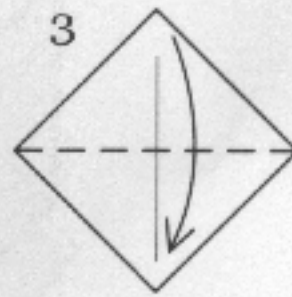

3  
Fold in half.

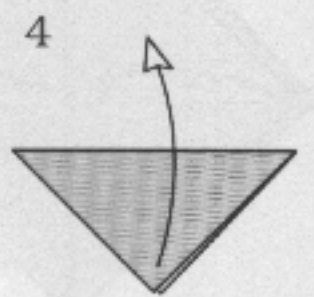

4  
Unfold.

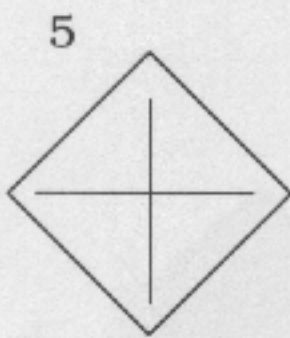

5



6  
Turn over.

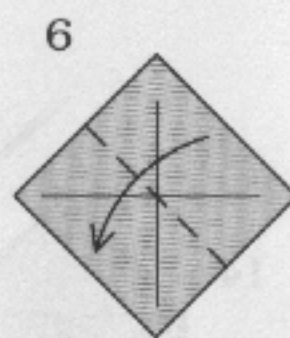

7

Book-fold.

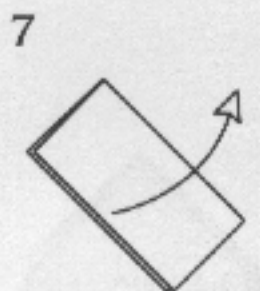

8

Unfold.

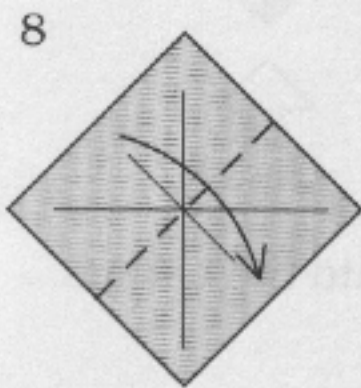

9

Book-fold.

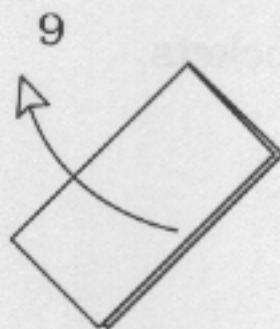

10

Unfold.

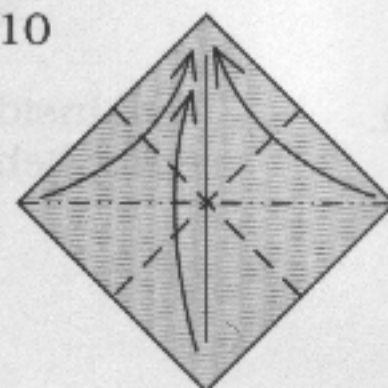

11

Collapse along the creases so that all the corners meet.

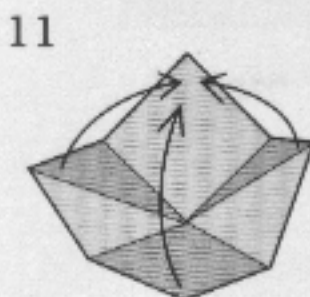

12

This is a three-dimensional intermediate step.

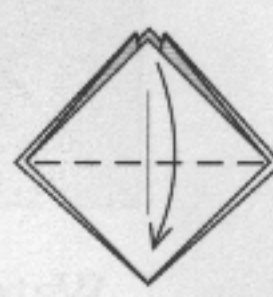

13

Repeat behind.

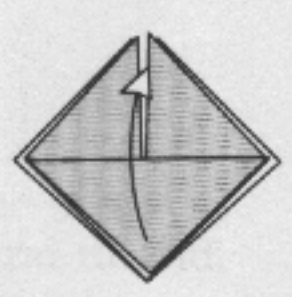

14

Unfold, repeat behind.

Fancy Box

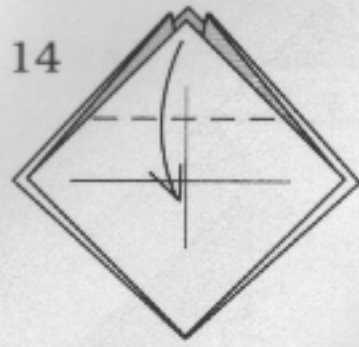

Repeat behind.

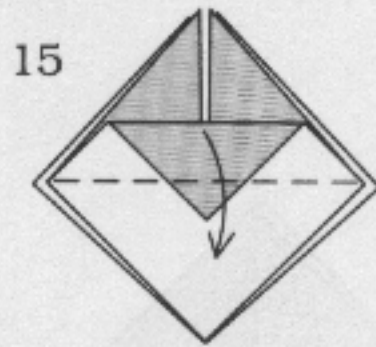

Repeat behind.

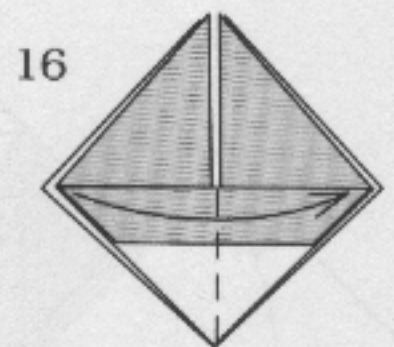

Repeat behind.

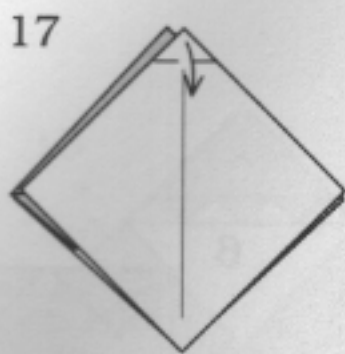

Fold the tip down, repeat behind.

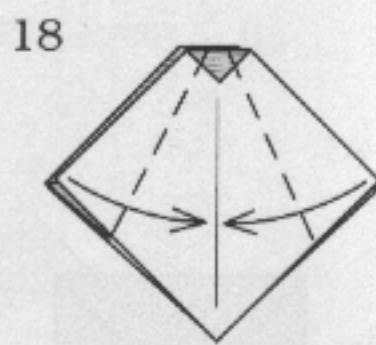

Kite-fold, repeat behind.

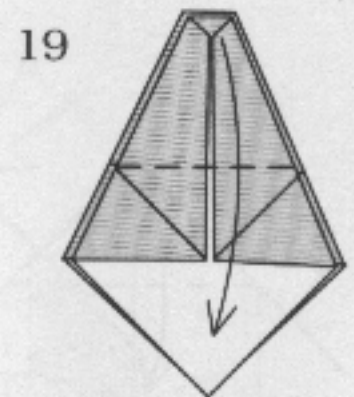

Repeat behind.

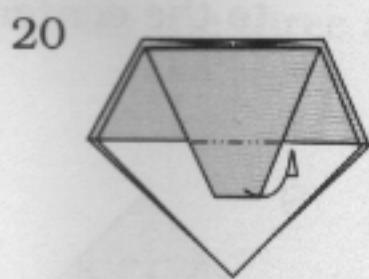

Tuck inside, repeat behind.

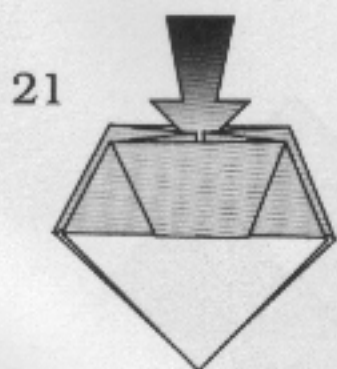

Open the box.

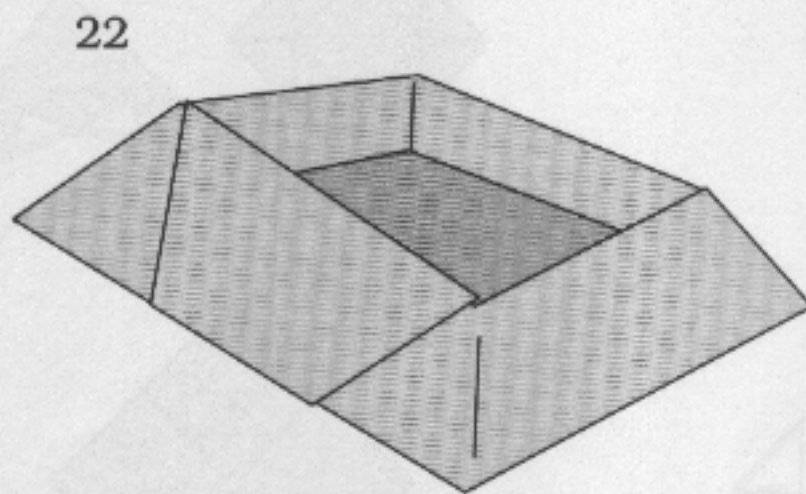

Candy Box

# Fancy Box

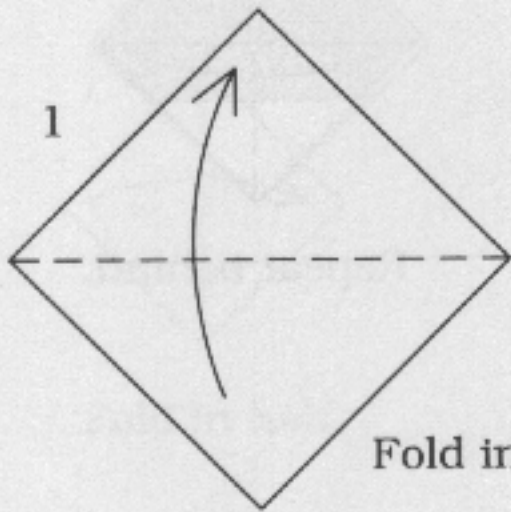

Fold in half.

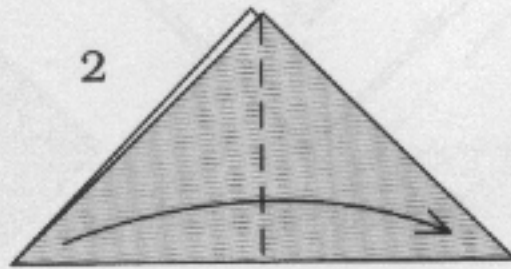

Fold in half.

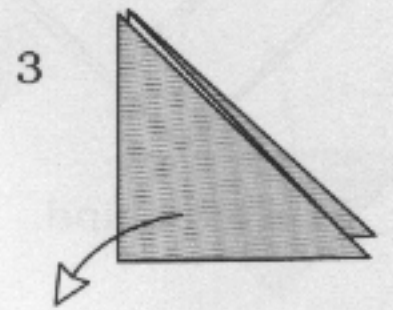

Unfold everything.

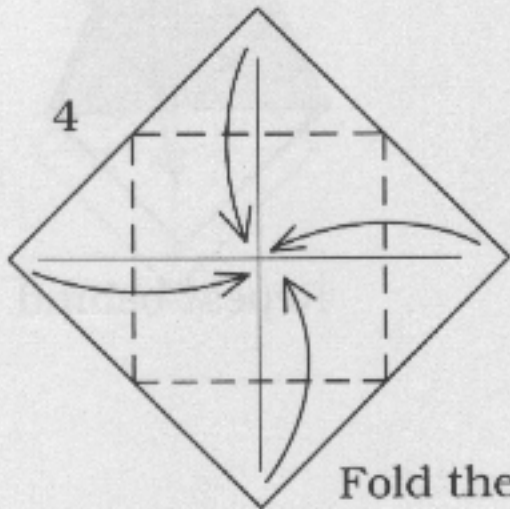

Fold the corners to the center.

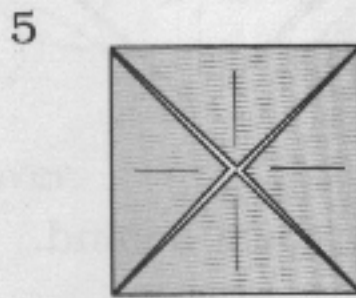

Turn over.

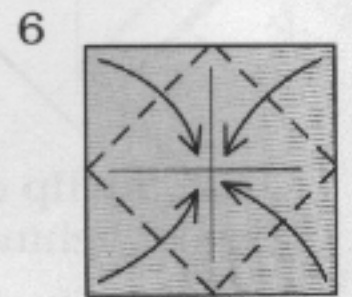

Fold the corners to the center.

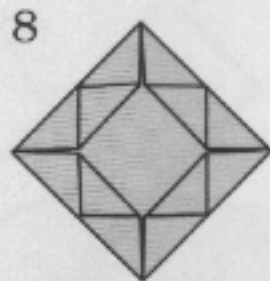

Turn over.

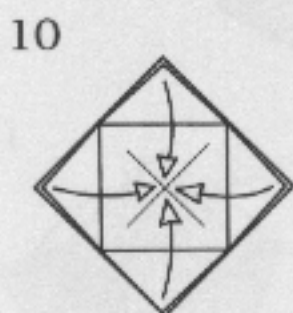
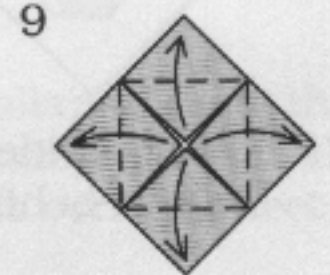

Unfold.

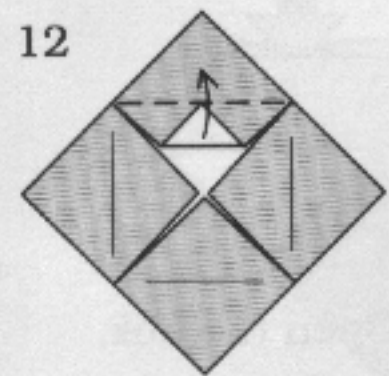
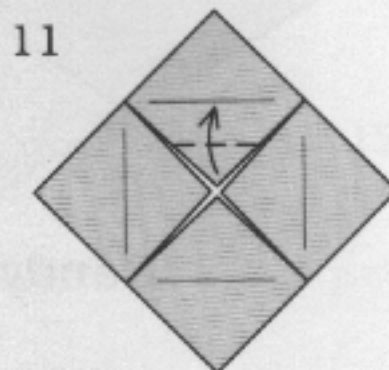

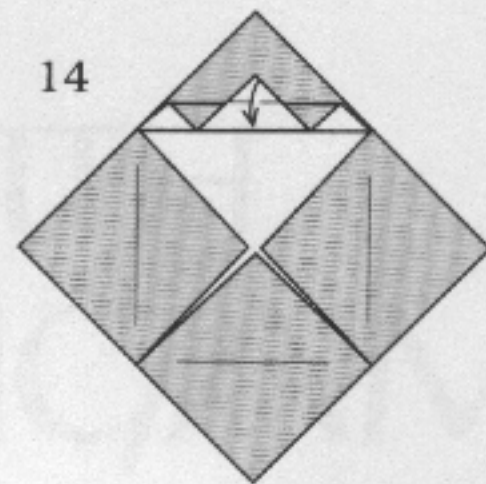
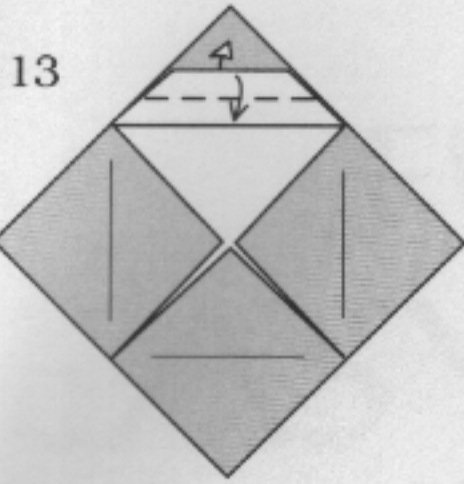

Let the corner slide out.

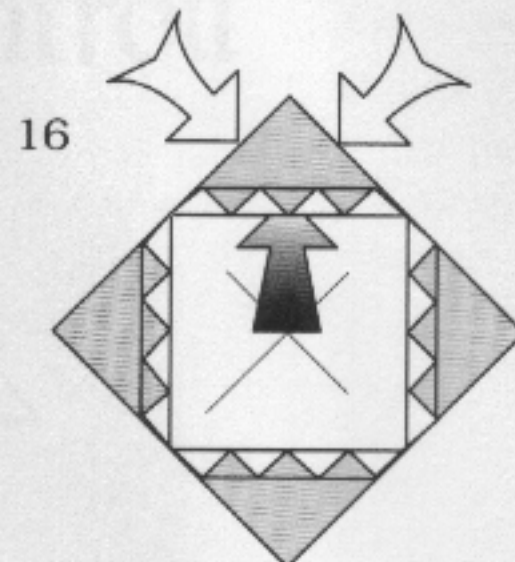
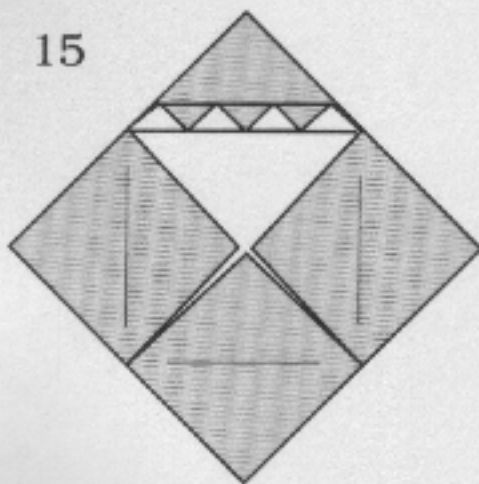

Repeat steps 11-14 on the three sides.

Place your finger inside and push from the outside. Repeat for each side.

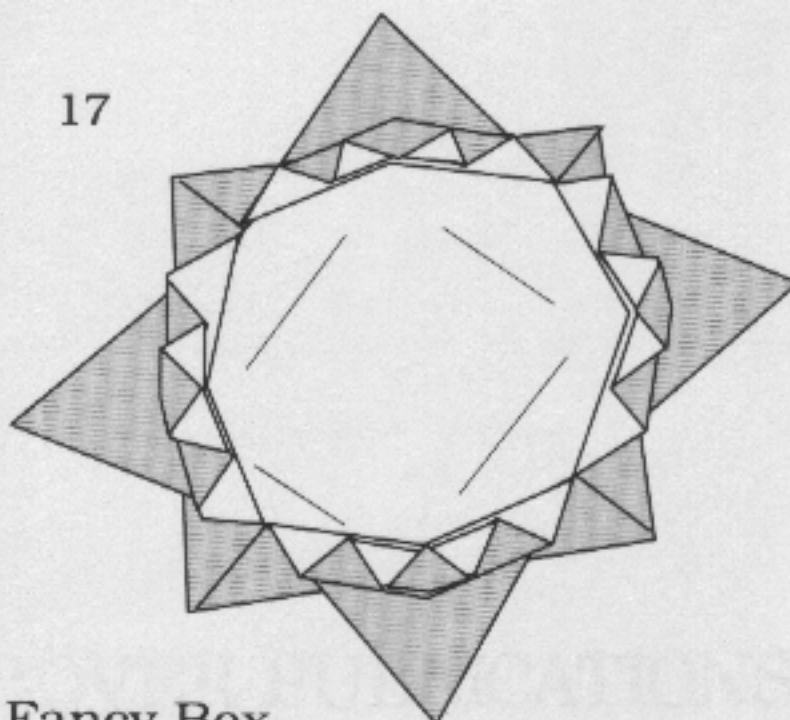

Fancy Box

# FUN WITH EASY ORIGAMI

48-page Booklet with 32 Projects and 24 Sheets of Origami Paper

## Dover Publications, Inc.

Inside this handy folder is everything a beginner needs to practice the ancient Japanese art of paper folding, including a clearly illustrated instructional booklet and a packet of authentic origami paper.

John Montroll's how-to book *Easy Origami* enables novices to grasp the fundamentals of the art quickly and to successfully complete 32 simple projects—among them, a hat, cup, pin wheel, boat, house and fish. Also included are directions for more challenging but still easy-to-make subjects such as a pigeon, pelican and piano.

Accompanying the instructions are 24 sheets of high-quality origami paper. Specially manufactured to resist tears and produce clean lines and crisp folds, the 7" x 7" sheets (2 each of 12 different colors) are perfect for creating a fascinating array of three-dimensional objects that will make intriguing party favors, holiday decorations and conversational pieces.

Original Dover (1993) publication. Instructional booklet. 24 sheets of 7" x 7" origami paper in 12 different colors. 9 $\frac{3}{8}$ " x 12 $\frac{3}{8}$ " shrink-wrapped folder.

### ALSO AVAILABLE

FUN WITH ORIGAMI: 17 EASY-TO-DO PROJECTS AND 24 SHEETS OF ORIGAMI PAPER, Dover. 9 x 12. 26664-8 Pa. \$4.95

EASY ORIGAMI, John Montroll. 48pp. 8 $\frac{1}{4}$  x 12. 27298-2 Pa. \$3.50

ANIMAL ORIGAMI FOR THE ENTHUSIAST: STEP-BY-STEP INSTRUCTIONS IN OVER 900 DIAGRAMS/25 ORIGINAL MODELS, John Montroll. 128pp. 9 x 12. 24792-9 Pa. \$9.95

ORIGAMI FOR THE ENTHUSIAST, John Montroll. 128pp. 9 x 12. 23799-0 Pa. \$8.95

LARGE ORIGAMI PAPER: 24 9" x 9" SHEETS IN 12 COLORS, Dover. 9 $\frac{3}{8}$ " x 12 $\frac{3}{8}$ ". 27295-8 Pa. \$4.95

ORIGAMI PAPER: 24 7" x 7" SHEETS IN 12 COLORS, Dover. 9 $\frac{3}{8}$ " x 12 $\frac{3}{8}$ ". 26829-2 Pa. \$3.95

Free Dover Crafts, Needlework & Cooking Catalog (59111-5) available upon request.

Cover photo by Bill Pell

ISBN 0-486-274



4.95 IN USA

0 78072 98705