

# English Made Easy

Learning English through Pictures

## VOLUME TWO

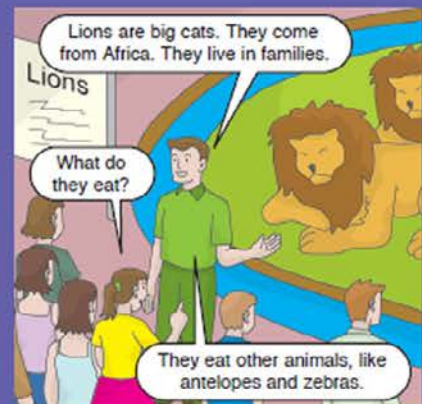

Jonathan Crichton  
and  
Pieter Koster

TUTTLE



# English Made Easy

Learning English Through Pictures

## VOLUME TWO

By Jonathan Crichton and Pieter Koster



TUTTLE Publishing

Tokyo | Rutland, Vermont | Singapore

## The Tuttle Story: “Books to Span the East and West”

Most people are surprised to learn that the world’s largest publisher of books on Asia had its humble beginnings in the tiny American state of Vermont. The company’s founder, Charles E. Tuttle, belonged to a New England family steeped in publishing. And his first love was naturally books—especially old and rare editions.

Immediately after WW II, serving in Tokyo under General Douglas MacArthur, Tuttle was tasked with reviving the Japanese publishing industry. He later founded the Charles E. Tuttle Publishing Company, which thrives today as one of the world’s leading independent publishers.

Though a westerner, Tuttle was hugely instrumental in bringing a knowledge of Japan and Asia to a world hungry for information about the East. By the time of his death in 1993, Tuttle had published over 6,000 books on Asian culture, history and art—a legacy honored by the Japanese emperor with the “Order of the Sacred Treasure,” the highest tribute Japan can bestow upon a non-Japanese.

With a backlist of 1,500 titles, Tuttle Publishing is more active today than at any time in its past—inspired by Charles Tuttle’s core mission to publish fine books to span the East and West and provide a greater understanding of each.



Published by Tuttle Publishing, an imprint of Periplus Editions (HK) Ltd.

[www.tuttlepublishing.com](http://www.tuttlepublishing.com)

Copyright © 2006 Periplus Editions (HK) Ltd.

All rights reserved. No part of this book may be reproduced or utilized in any form or by any means, electronic or mechanical, including photocopying, recording, or by any information storage or retrieval system, without permission in writing from the publisher.

ISBN: 978-1-4629-0969-8 (ebook)

Distributed by:

### North America, Latin America & Europe

Tuttle Publishing  
364 Innovation Drive  
North Clarendon,  
VT 05759-9436 U.S.A.  
Tel: 1 (802) 773-8930  
Fax: 1 (802) 773-6993  
[info@tuttlepublishing.com](mailto:info@tuttlepublishing.com)  
[www.tuttlepublishing.com](http://www.tuttlepublishing.com)

### Japan

Tuttle Publishing  
Yaekari Building, 3rd Floor  
5-4-12 Osaki, Shinagawa-ku,  
Tokyo 141 0032  
Tel: (81) 3 5437-0171  
Fax: (81) 3 5437-0755  
[sales@tuttle.co.jp](mailto:sales@tuttle.co.jp)  
[www.tuttle.co.jp](http://www.tuttle.co.jp)

### Asia Pacific

Berkeley Books Pte. Ltd.  
61 Tai Seng Avenue  
#02-12 Singapore 534167  
Tel: (65) 6280-1330  
Fax: (65) 6280-6290  
[inquiries@periplus.com.sg](mailto:inquiries@periplus.com.sg)  
[www.periplus.com](http://www.periplus.com)

15 14 13 12                      8 7 6 5 4 3  
1202CP

Printed in Singapore

TUTTLE PUBLISHING® is a registered trademark of Tuttle Publishing, a division of Periplus Editions (HK) Ltd.

# Contents

FUNCTION	GRAMMAR	VOCABULARY
<b>UNIT 1: Here's a letter for you. .... 6</b>		
<ul style="list-style-type: none"> <li>Communicating with friends</li> </ul>	<ul style="list-style-type: none"> <li>Imperatives</li> <li>Paired verbs</li> </ul>	<ul style="list-style-type: none"> <li>Prepositions</li> <li>Definite article</li> </ul>
		<ul style="list-style-type: none"> <li>Family relationships</li> <li>Correspondence</li> </ul>
<b>UNIT 2: Let's check the flight number again. .... 16</b>		
<ul style="list-style-type: none"> <li>Describing time</li> <li>Reporting events</li> <li>Checking details</li> </ul>	<ul style="list-style-type: none"> <li>Reported speech</li> <li>Adjectives (present and past participles)</li> <li>Adverbs of frequency (1)</li> </ul>	<ul style="list-style-type: none"> <li>Timetables and deadlines</li> <li>Feelings</li> </ul>
<b>UNIT 3: It's a goal! .... 26</b>		
<ul style="list-style-type: none"> <li>Talking about accommodation</li> </ul>	<ul style="list-style-type: none"> <li>There is/are</li> <li>Prepositions</li> </ul>	<ul style="list-style-type: none"> <li>Enough</li> <li>Too much</li> </ul>
		<ul style="list-style-type: none"> <li>Accommodation</li> <li>Quantity/division</li> </ul>
<b>UNIT 4: I want a chocolate bar! .... 34</b>		
<ul style="list-style-type: none"> <li>Making plans</li> </ul>	<ul style="list-style-type: none"> <li>Present continuous with future meaning</li> <li>Present perfect</li> <li>While</li> </ul>	<ul style="list-style-type: none"> <li>While</li> <li>Around</li> </ul>
<b>UNIT 5: Revision and extension .... 44</b>		
<b>UNIT 6: You always watch movies! .... 54</b>		
<ul style="list-style-type: none"> <li>Giving preferences</li> <li>Expressing hopes</li> <li>Describing the weather</li> <li>Making offers</li> </ul>	<ul style="list-style-type: none"> <li>I'd like/I'd rather</li> <li>I hope...</li> <li>Instead (of)</li> <li>1st conditional</li> </ul>	<ul style="list-style-type: none"> <li>Electronic appliances</li> <li>Television programs</li> <li>Weather</li> </ul>
<b>UNIT 7: I'd like to see a doctor. .... 62</b>		
<ul style="list-style-type: none"> <li>Seeking clarification</li> <li>Travelling on public transport</li> </ul>	<ul style="list-style-type: none"> <li>Which...?</li> <li>Because/so</li> <li>Comparatives (1)</li> </ul>	<ul style="list-style-type: none"> <li>Paired verbs</li> </ul>
		<ul style="list-style-type: none"> <li>Travel</li> <li>Memory</li> <li>Make-up</li> </ul>
<b>UNIT 8: Ten dollars extra. .... 70</b>		
<ul style="list-style-type: none"> <li>Asking questions</li> </ul>	<ul style="list-style-type: none"> <li>Wh questions</li> </ul>	<ul style="list-style-type: none"> <li>Duration</li> <li>Zoo</li> <li>Animals</li> </ul>
<b>UNIT 9: Where is Sue? .... 78</b>		
<ul style="list-style-type: none"> <li>Describing location</li> <li>Expressing possibility</li> </ul>	<ul style="list-style-type: none"> <li>Modals of possibility</li> <li>Prepositions</li> <li>Too + adjective</li> <li>Not... enough</li> </ul>	<ul style="list-style-type: none"> <li>Position</li> <li>Movement</li> </ul>

FUNCTION	GRAMMAR	VOCABULARY
<b>UNIT 10: Revision and extension</b> ..... 86		
<b>UNIT 11: I'm wearing one, too.</b> ..... 96		
<ul style="list-style-type: none"> <li>Speculating and justifying</li> </ul>	<ul style="list-style-type: none"> <li>Reflexive pronouns</li> <li>Modals of deduction</li> <li>In case...      • Either</li> </ul>	<ul style="list-style-type: none"> <li>Clothes</li> <li>Furniture</li> <li>Damage</li> </ul>
<b>UNIT 12: You'd better go to the dentist.</b> ..... 106		
<ul style="list-style-type: none"> <li>Giving advice</li> </ul>	<ul style="list-style-type: none"> <li>Causatives      • You'd better..</li> <li>Un + adjectives</li> <li>Comparatives with than</li> </ul>	<ul style="list-style-type: none"> <li>Repairs</li> <li>Injuries</li> </ul>
<b>UNIT 13: I was having breakfast when the phone rang.</b> ..... 114		
<ul style="list-style-type: none"> <li>Describing medical problems</li> <li>Making recommendations</li> </ul>	<ul style="list-style-type: none"> <li>Interrupted past</li> <li>Modals of obligation</li> <li>Until</li> <li>Soon                      • Few</li> </ul>	<ul style="list-style-type: none"> <li>Parts of the body</li> <li>Medical problems</li> <li>Symptoms</li> <li>Treatments</li> </ul>
<b>UNIT 14: Do you have a receipt?</b> ..... 122		
<ul style="list-style-type: none"> <li>Buying goods</li> <li>Renting services</li> <li>Describing size and distance</li> </ul>	<ul style="list-style-type: none"> <li>Grammar of numbers</li> </ul>	<ul style="list-style-type: none"> <li>Financial transactions</li> <li>Insurance</li> <li>Measurement      • Simple maths</li> </ul>
<b>UNIT 15: Revision and extension</b> ..... 132		
<b>UNIT 16: Can I try them on?</b> ..... 142		
<ul style="list-style-type: none"> <li>Choosing prices and sizes</li> </ul>	<ul style="list-style-type: none"> <li>Comparatives (2)</li> <li>Other/the others</li> </ul>	<ul style="list-style-type: none"> <li>Shopping              • Sizes</li> <li>Prices, discounts and sales</li> </ul>
<b>UNIT 17: Neither can I.</b> ..... 150		
<ul style="list-style-type: none"> <li>Ordering in restaurants</li> </ul>	<ul style="list-style-type: none"> <li>Every..                      • Until</li> <li>Neither/so</li> </ul>	<ul style="list-style-type: none"> <li>Food</li> <li>Eating in restaurants</li> </ul>
<b>UNIT 18: If I won, I'd buy a new car.</b> ..... 160		
<ul style="list-style-type: none"> <li>Talking about conditions and consequences</li> </ul>	<ul style="list-style-type: none"> <li>Conditionals</li> <li>Adverbs of frequency (2)</li> <li>As..as                      • Can/can't (ability)</li> </ul>	<ul style="list-style-type: none"> <li>Empty</li> <li>Full</li> </ul>
<b>UNIT 19: I wish I could play the piano.</b> ..... 168		
<ul style="list-style-type: none"> <li>Expressing wishes      • Saying goodbye</li> <li>Congratulating</li> </ul>	<ul style="list-style-type: none"> <li>As soon as</li> </ul>	<ul style="list-style-type: none"> <li>Celebrations              • Farewells</li> <li>Applications</li> </ul>
<b>UNIT 20: Revision and extension</b> ..... 178		
<b>Grammar/Function/Topic, Index</b> ..... 188		

## Preface

In an increasingly international world, being able to communicate in English is nowadays a necessity in social, professional and business life. Competence in English creates an increasing range of business, travel and leisure opportunities, opening doors to international communication.

*English Made Easy* is a breakthrough in English language learning – imaginatively exploiting how pictures and text can work together to create understanding and help learners learn more productively.

*English Made Easy* gives learners easy access to the vocabulary, grammar and functions of English as it is actually used in a comprehensive range of social situations. Self-guided students and classroom learners alike will be delighted by the way they are helped to progress easily from one unit to the next, using the combinations of pictures and text to discover for themselves how English works.

The *English Made Easy* method is based on a thorough understanding of language structure and how language is successfully learned. The authors are experienced English language teachers with strong backgrounds in language analysis and language learning. The *English Made Easy* team is confident that the books represent a significant development in English language learning.

— Professor Christopher N. Candlin

## Using this book

This book is easy to use. You will learn how to speak English by looking at the pictures and words on each page. The pictures explain the words.

The table of contents tells you what you will learn in each of the twenty units. You can use this table to look up any particular points you want to learn or practice.

The twenty units are arranged in groups of five. The first four units present language and give you opportunities to practice as you learn. The first page of each unit has a list of all the words and phrases you will learn in that unit. At the end of each unit there is an interesting story which uses the language you have just learned.

The fifth unit in each group gives you the opportunity to revise the language in the first four units and to use it in different situations. The exercises are easy to understand and there is an answer key at the end of the unit.

At the end of the book there is an index which contains all the words and phrases in the book. It is not a dictionary. It refers you to the unit in which that language first appears so that you can “discover” the meaning of the word by seeing it in context.

# UNIT 1: Here's a letter for you.

grandfather  
 grandmother  
 daughter-in-law  
 son-in-law  
 brother-in-law  
 sister-in-law  
 uncle  
 aunt  
 niece  
 nephew  
 cousin

open                      on  
 close                     off

letter                      postman  
 invitation                card  
 postcard                 bill  
 envelope                stamp  
 parcel                    fax  
 letterbox                airmail  
 email

all

lay the table  
 make the toast  
 butter the toast  
 pass the milk  
 clear the table  
 load the dishwasher

to                              from

arrive at  
 depart from  
 land  
 take off

holidays  
 look forward to        want  
 hurry up                quickly

chair                      cat  
 sofa

put

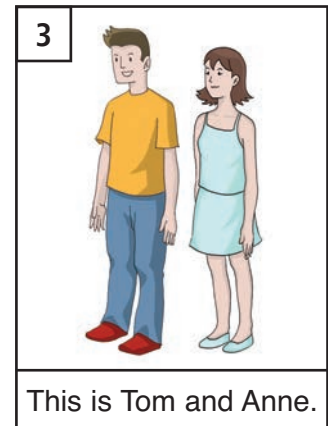
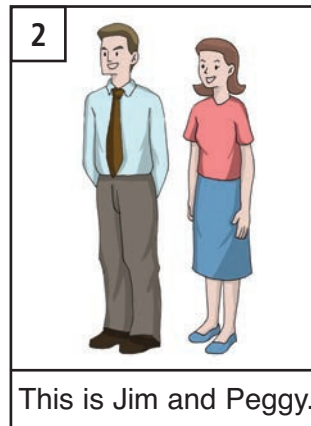
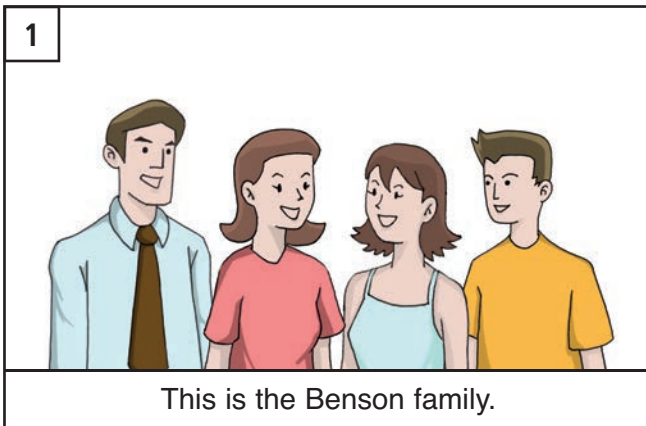

### The Benson Family

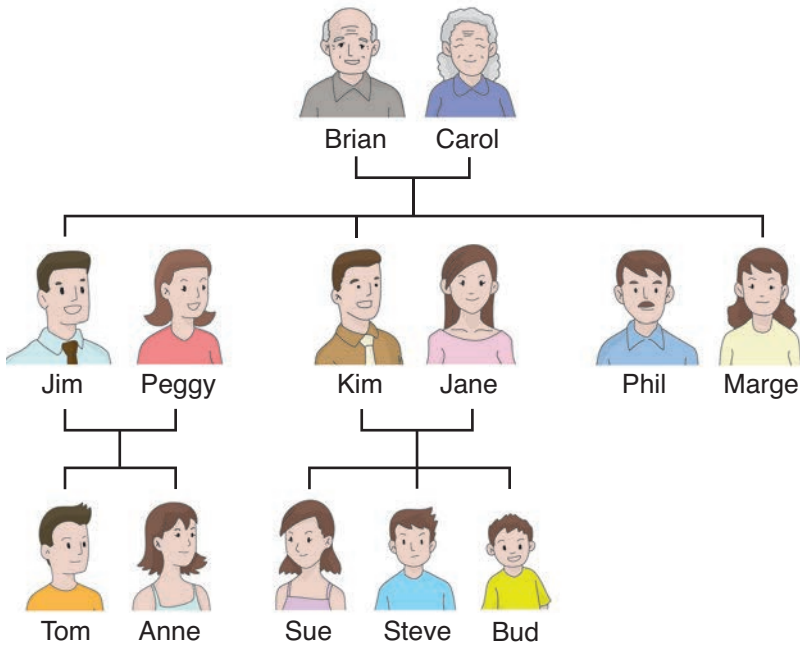

1. Jim is Anne's father.
2. Anne is Jim's daughter.
3. Tom is Anne's brother.
4. Marge is Jim's sister.
5. Kim is Jim's brother.
6. Brian is Jim's father.
7. Brian is Tom's grandfather.
8. Carol is Tom's grandmother.
9. Marge is Carol's daughter.
10. Peggy is Carol's daughter-in-law.
11. Kim is Anne's uncle.
12. Marge is Anne's aunt.
13. Sue is Anne's cousin.
14. Anne is Sue's cousin.
15. Sue is Jim's niece.
16. Steve is Jim's nephew.
17. Jane is Jim's sister-in-law.
18. Kim is Peggy's brother-in-law.
19. Phil is Carol's son-in law.

### The Taylor Family

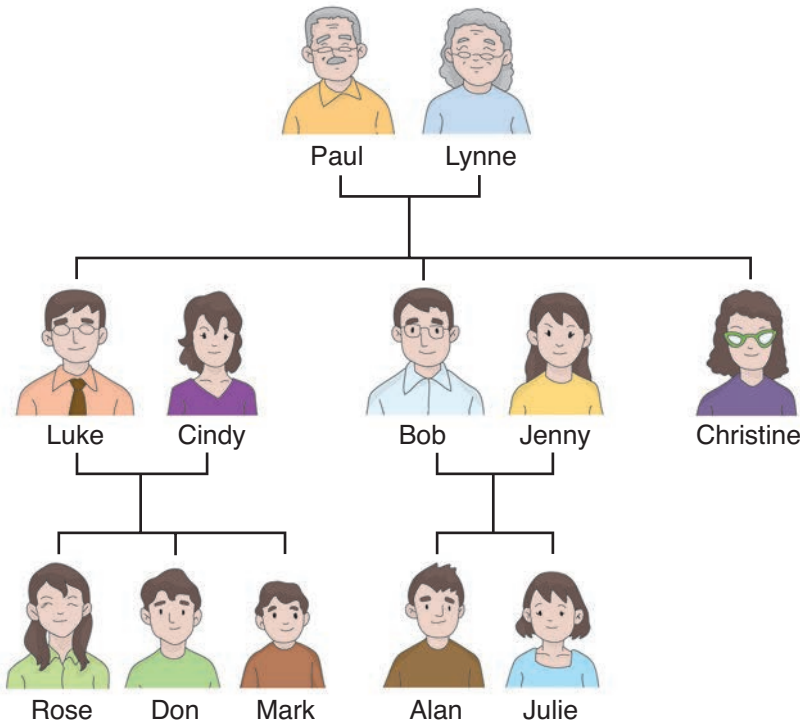

1. Bob is Julie's \_\_\_\_\_.
2. Julie is Bob's \_\_\_\_\_.
3. Alan is Julie's \_\_\_\_\_.
4. Lynne is Alan's \_\_\_\_\_.
5. Cindy is Bob's \_\_\_\_\_.
6. Paul is Bob's \_\_\_\_\_.
7. Jenny is Lynne's \_\_\_\_\_.
8. Luke is Bob's \_\_\_\_\_.
9. Christine is Lynne's \_\_\_\_\_.
10. Rose is Julie's \_\_\_\_\_.
11. Luke is Julie's \_\_\_\_\_.
12. Christine is Julie's \_\_\_\_\_.
13. Christine is Bob's \_\_\_\_\_.
14. Julie is Rose's \_\_\_\_\_.
15. Paul is Alan's \_\_\_\_\_.
16. Don is Bob's \_\_\_\_\_.
17. Rose is Bob's \_\_\_\_\_.
18. Luke is Jenny's \_\_\_\_\_.

UNIT 1

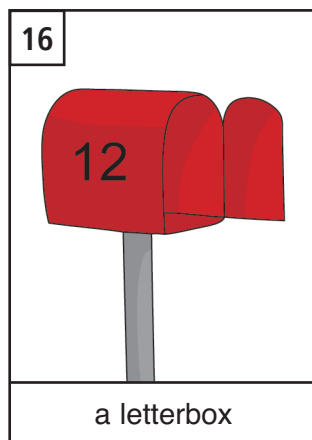
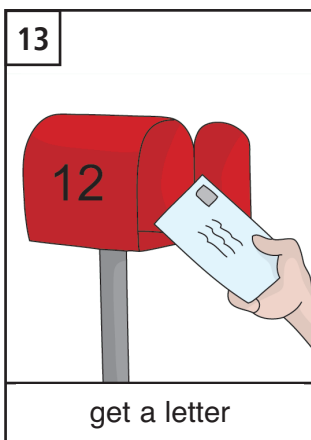
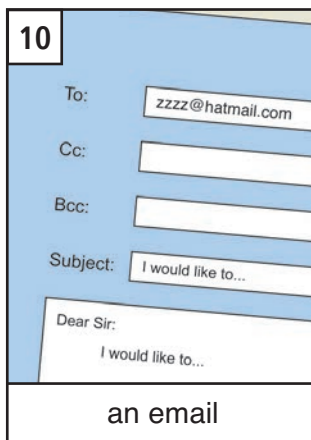
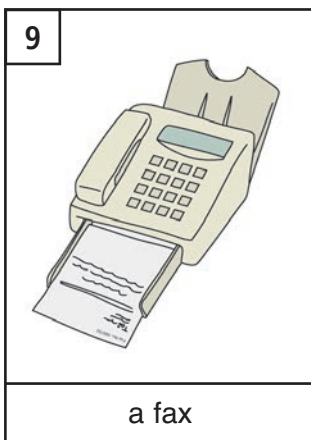
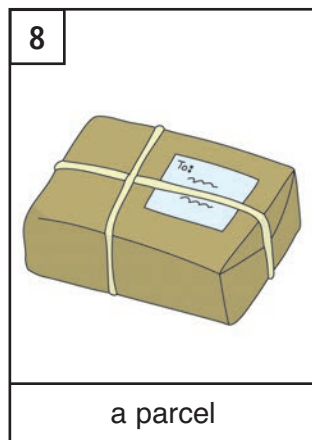
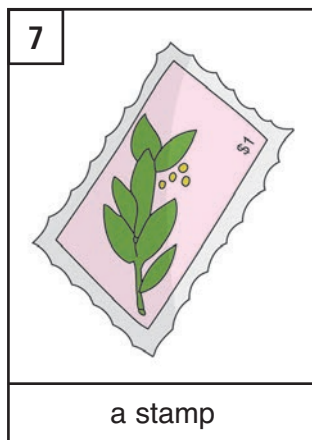
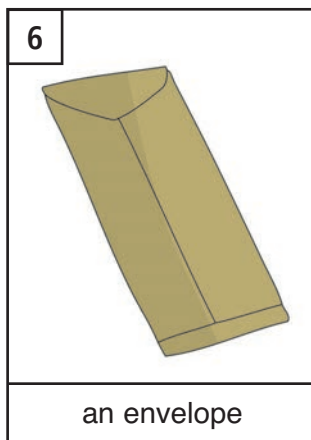
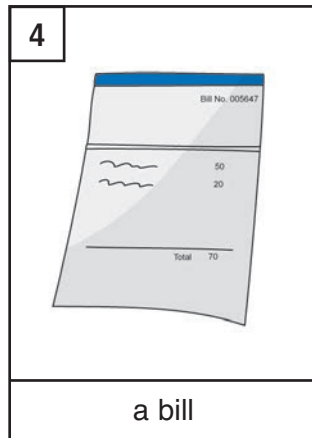
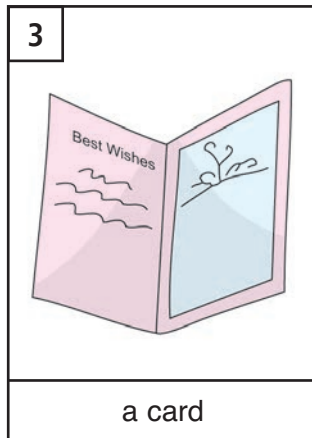
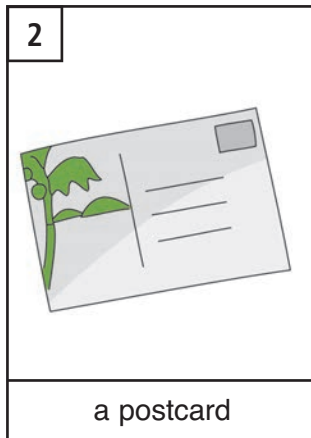
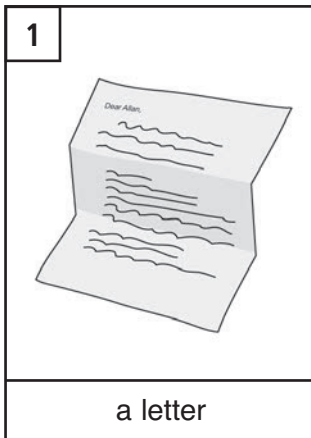



who is = who's

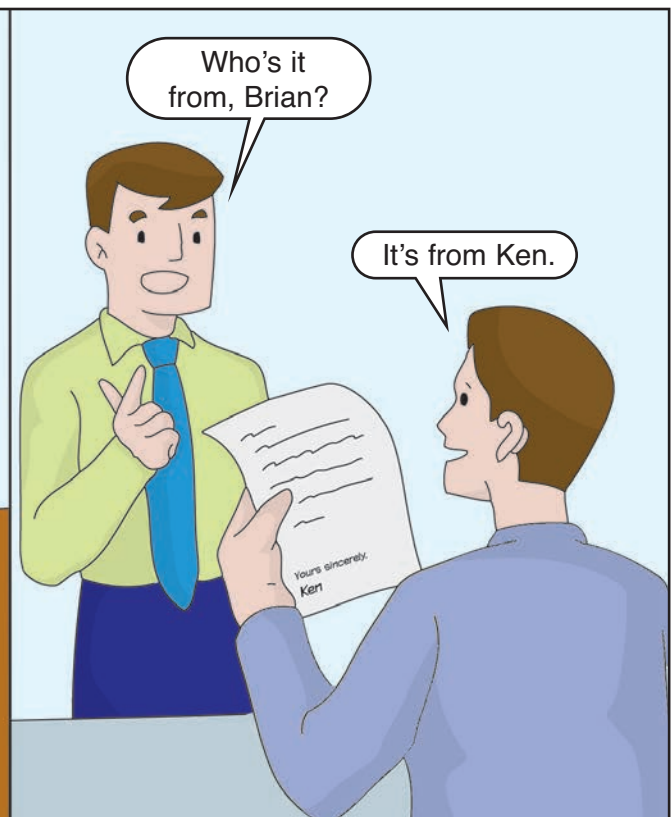
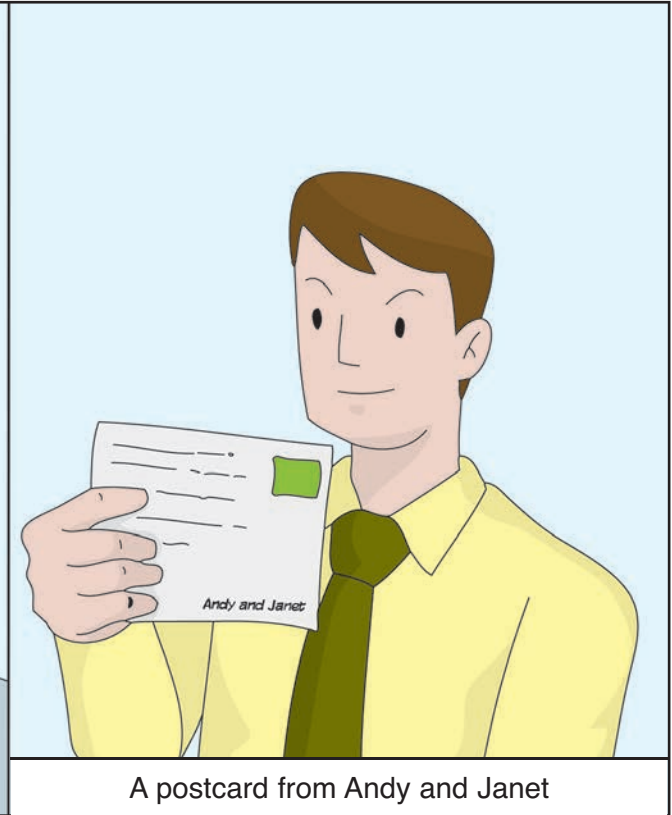

UNIT 1

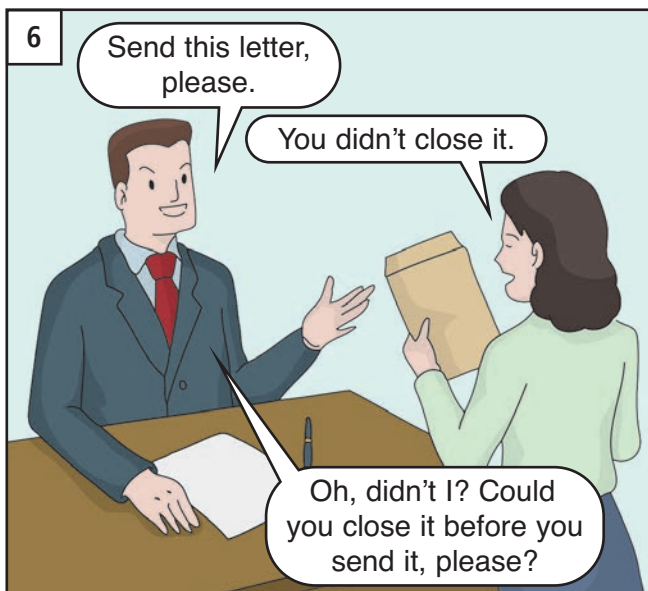
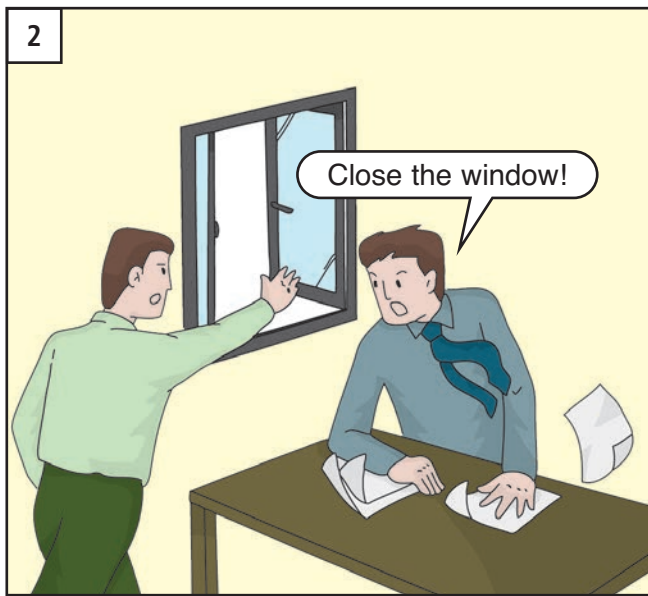

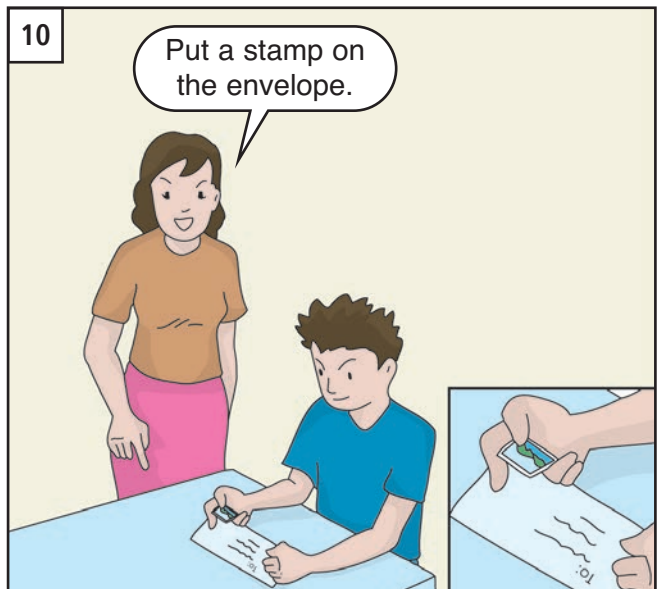
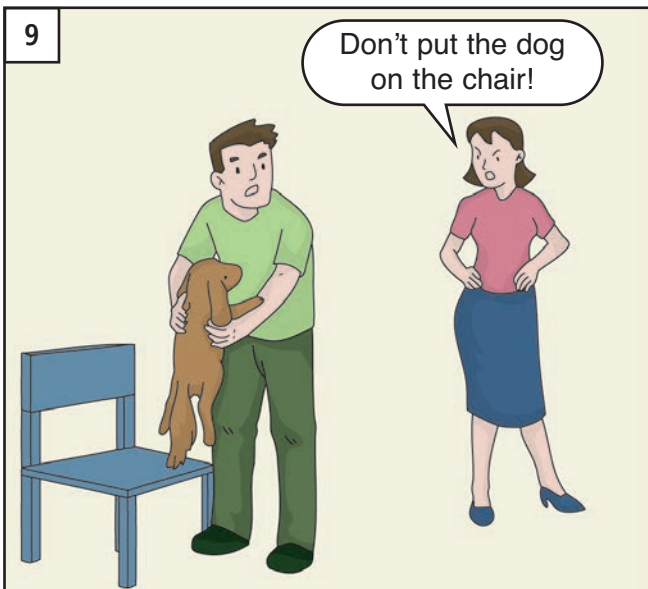
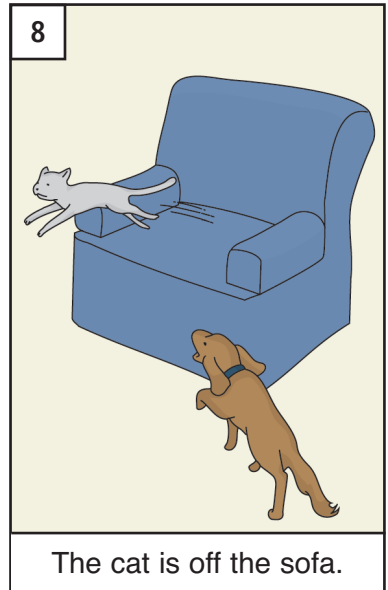
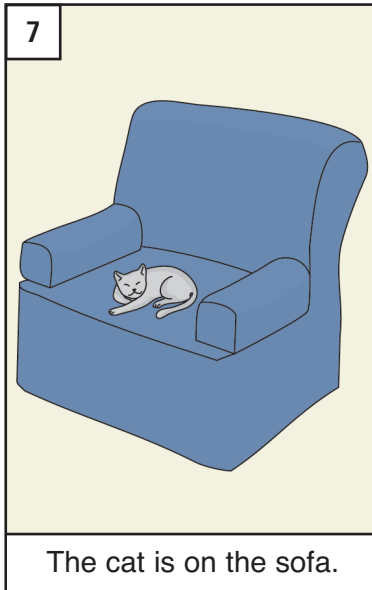
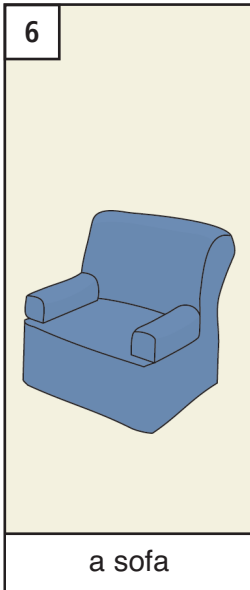
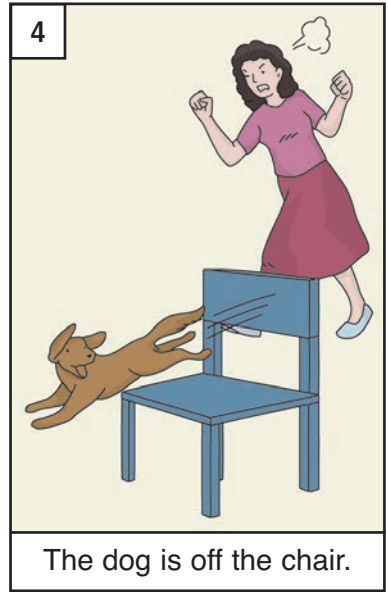
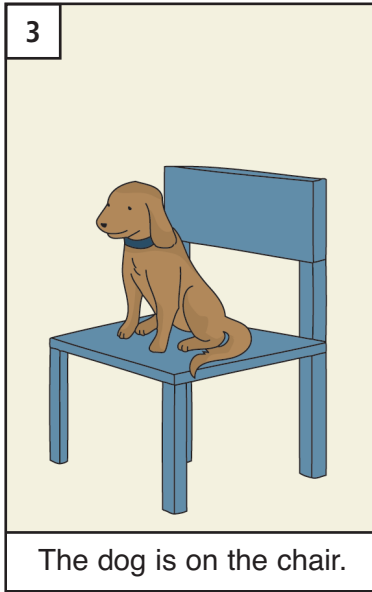
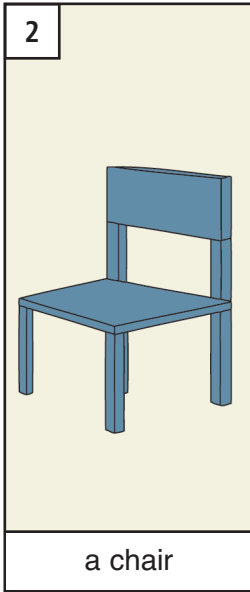
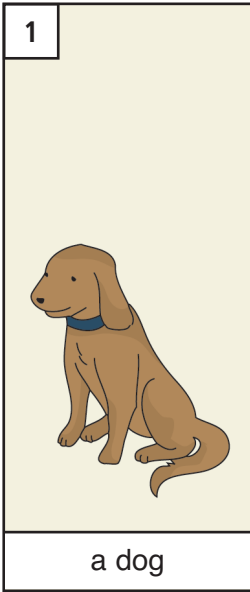

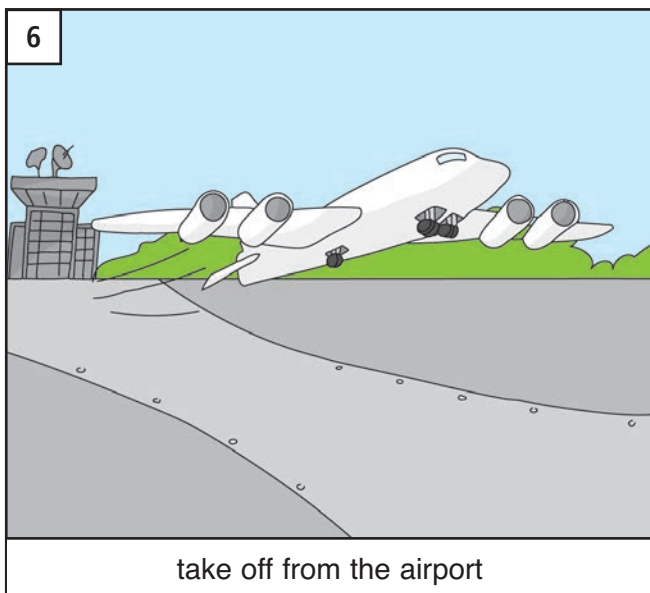
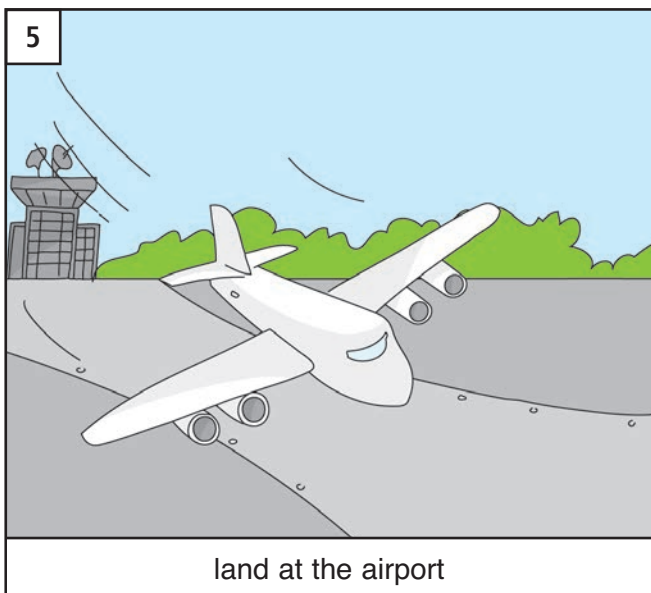
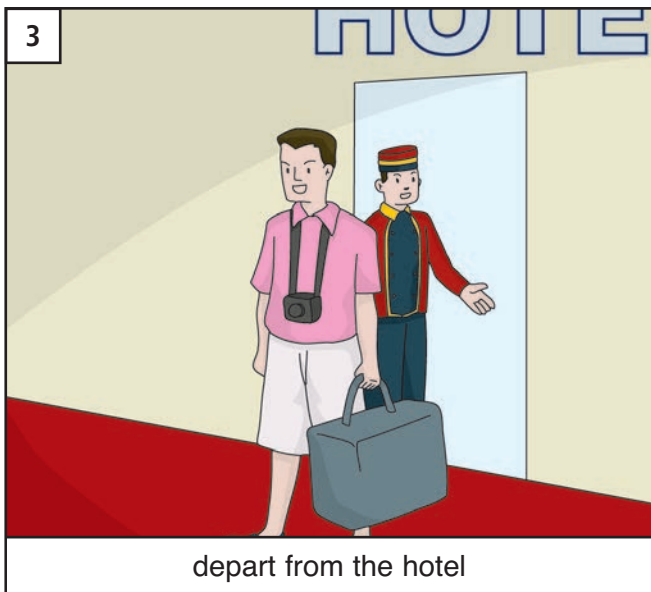
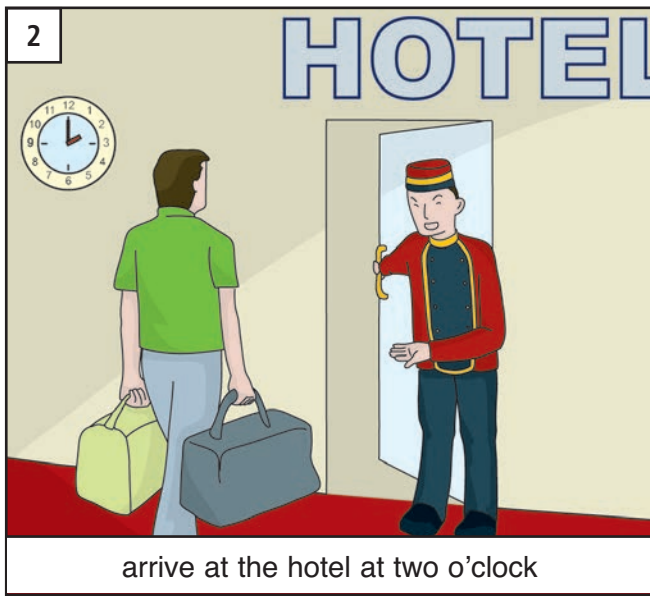

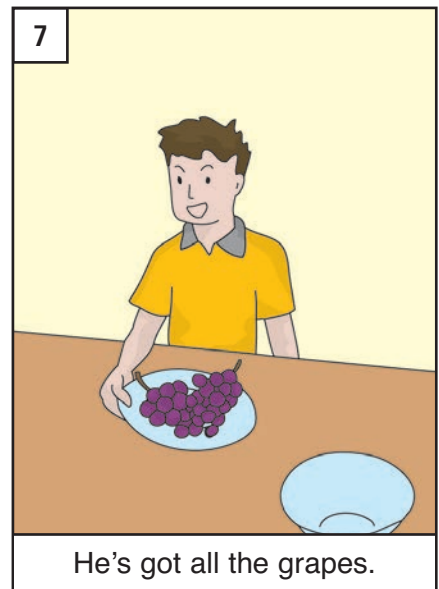
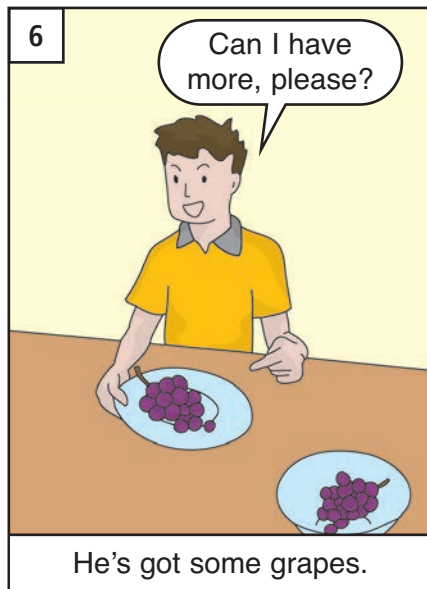
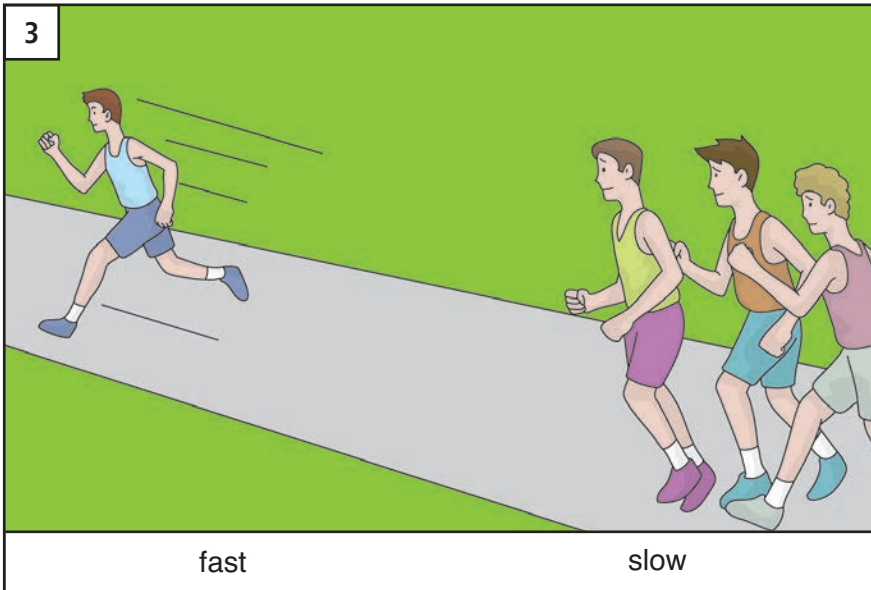
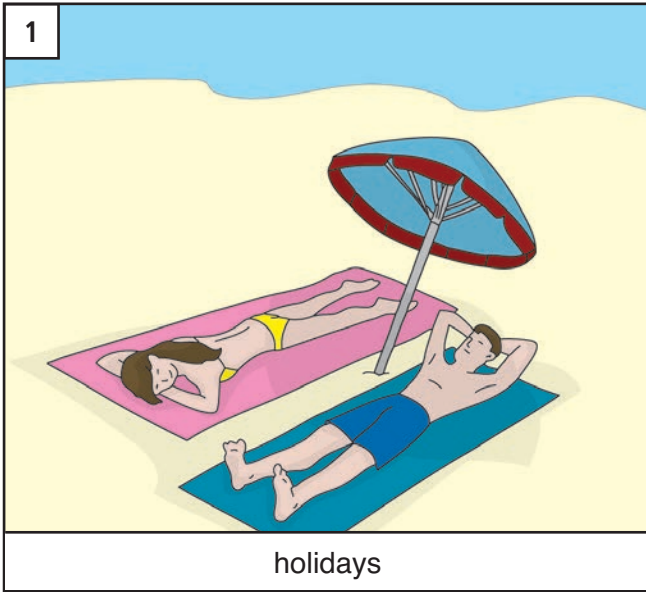

# The Bensons



This is the Benson's house. The postman is putting a letter in the letterbox.

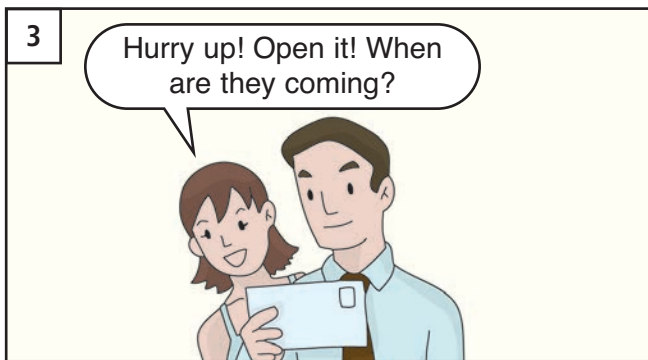
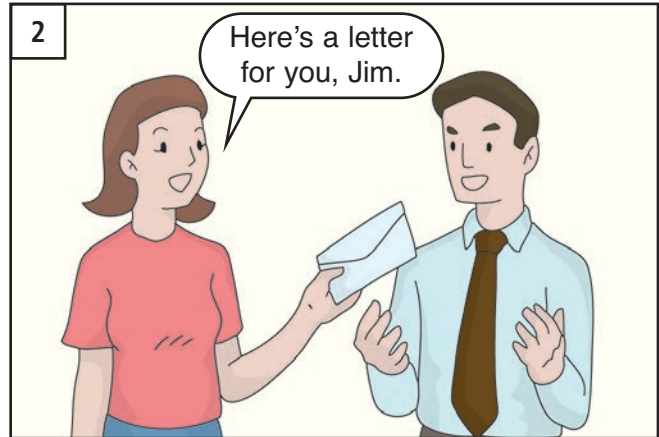

Anne wants Jim to open the letter quickly.

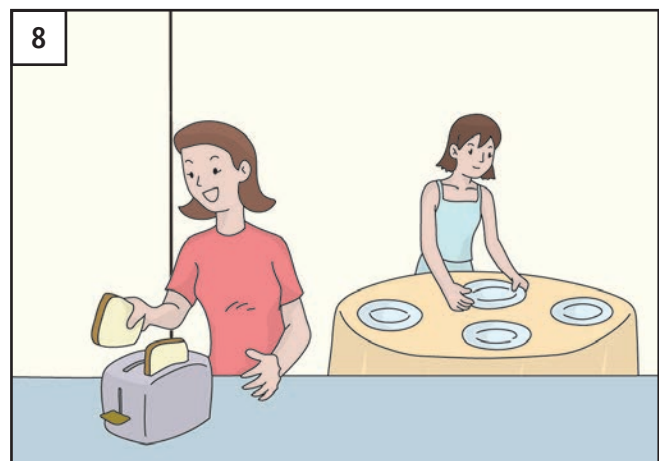
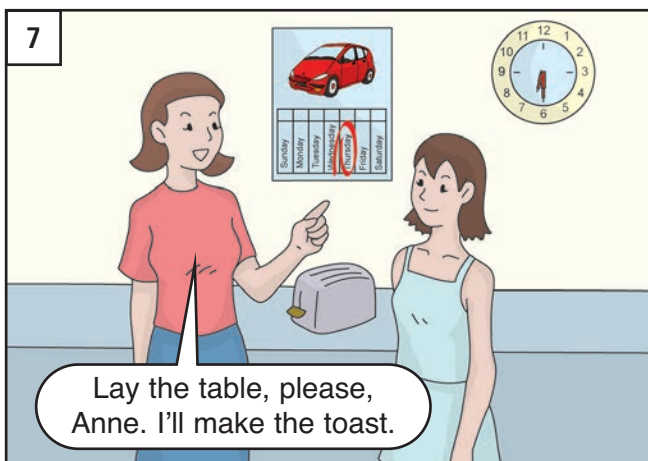
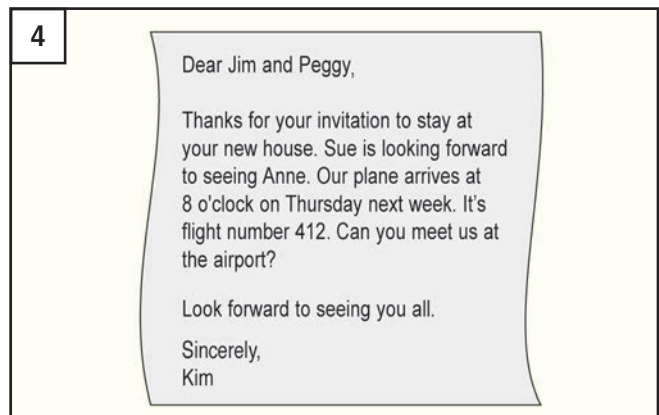

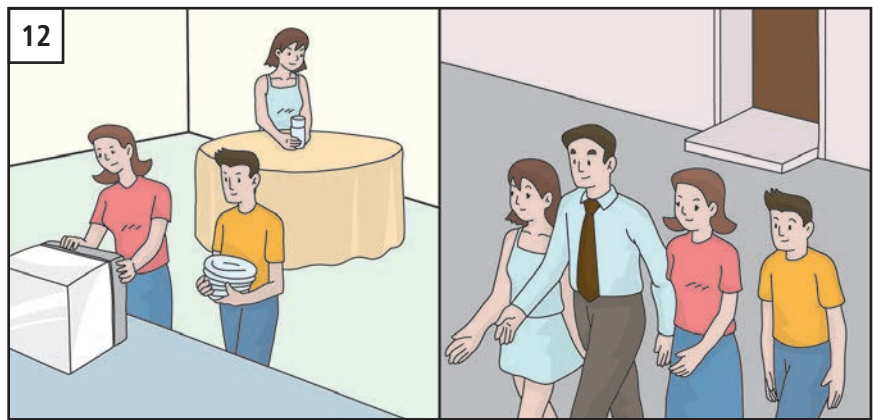
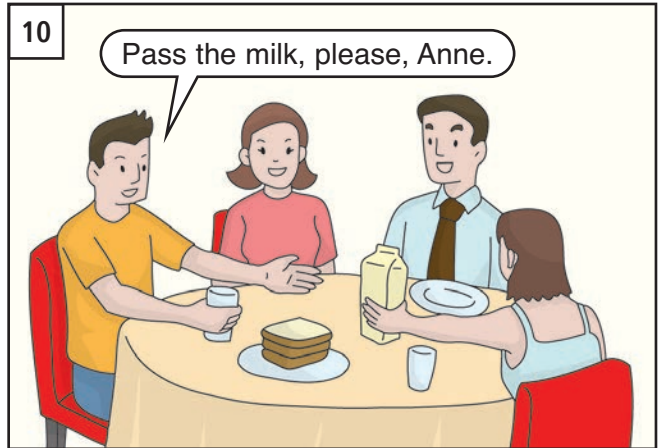
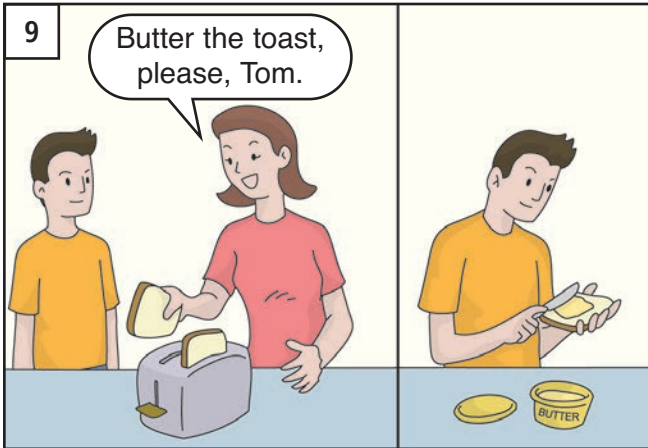

## UNIT 2: Let's check the flight number again.

once  
twice  
three times  
always  
sometimes  
never  
again  
  
on time

a bit

interesting  
boring  
interested  
bored  
frightening  
frightened  
surprising  
surprised  
tiring  
tired  
exciting  
excited

bell  
ring

accident  
trophy  
student

right (not wrong)  
wrong  
check

say  
tell



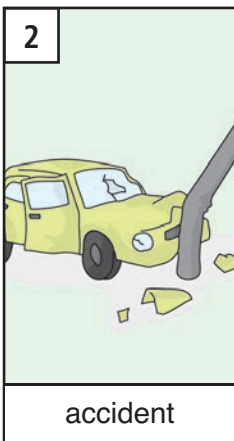
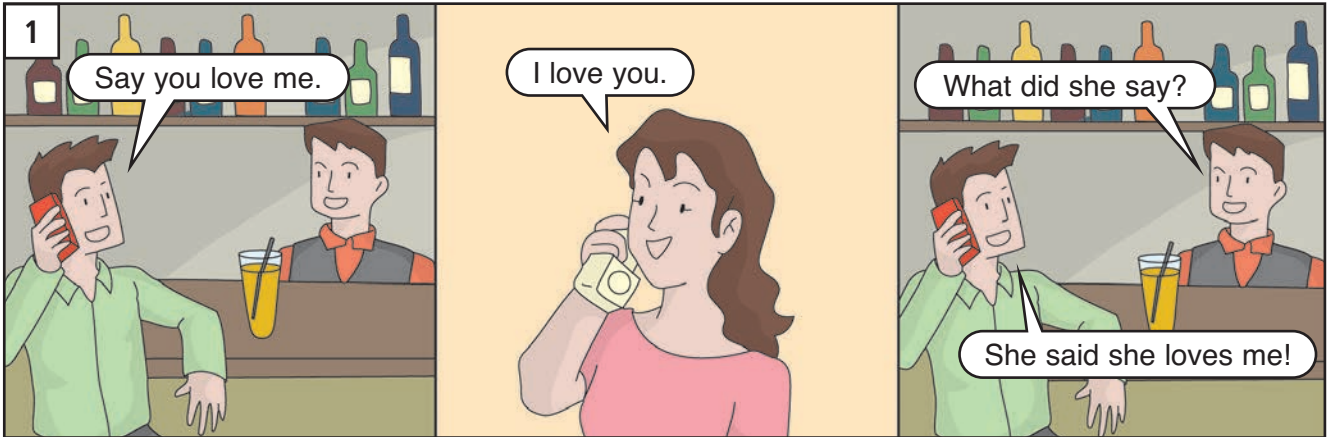

UNIT 2

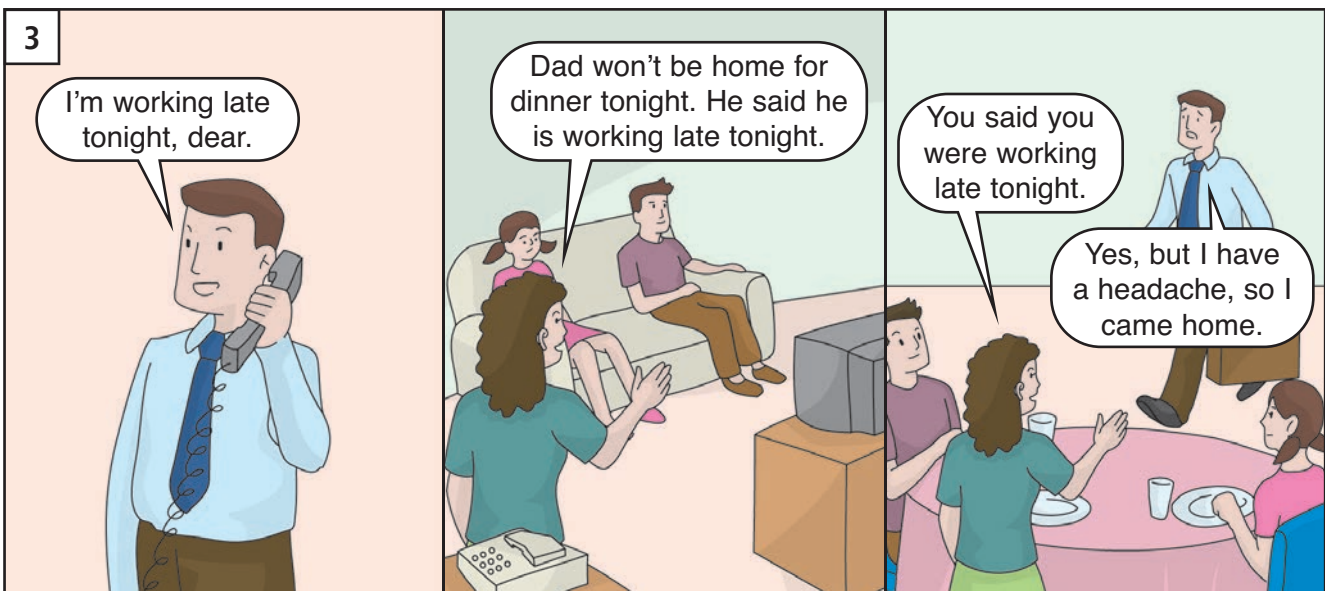
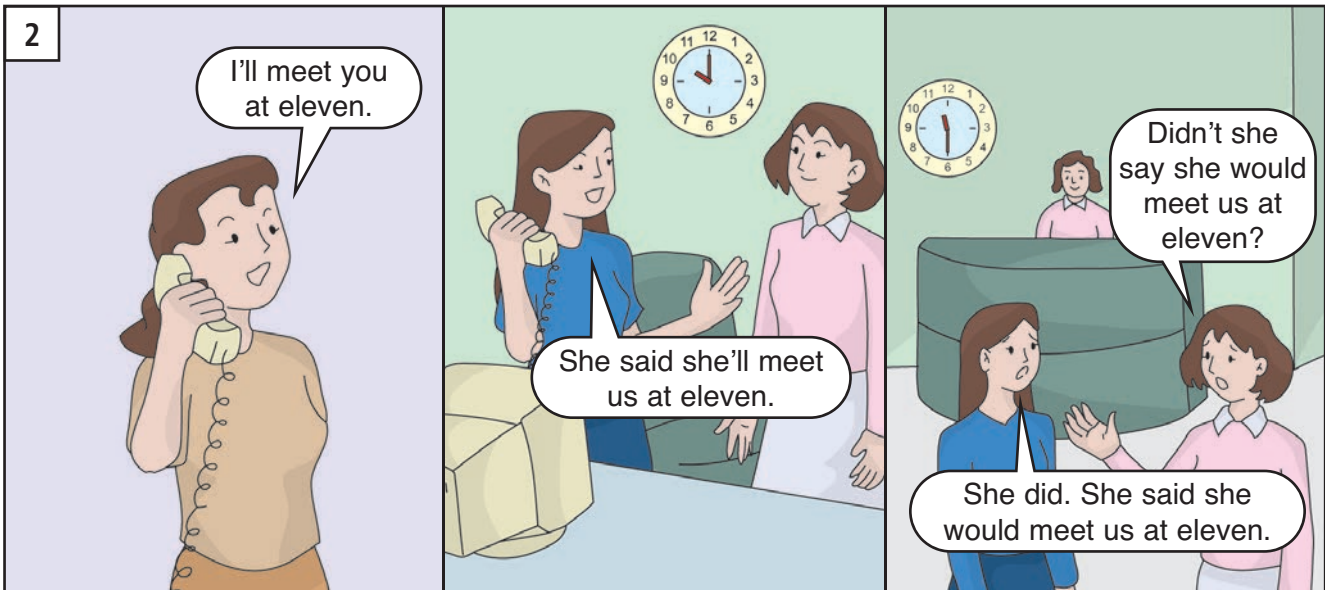
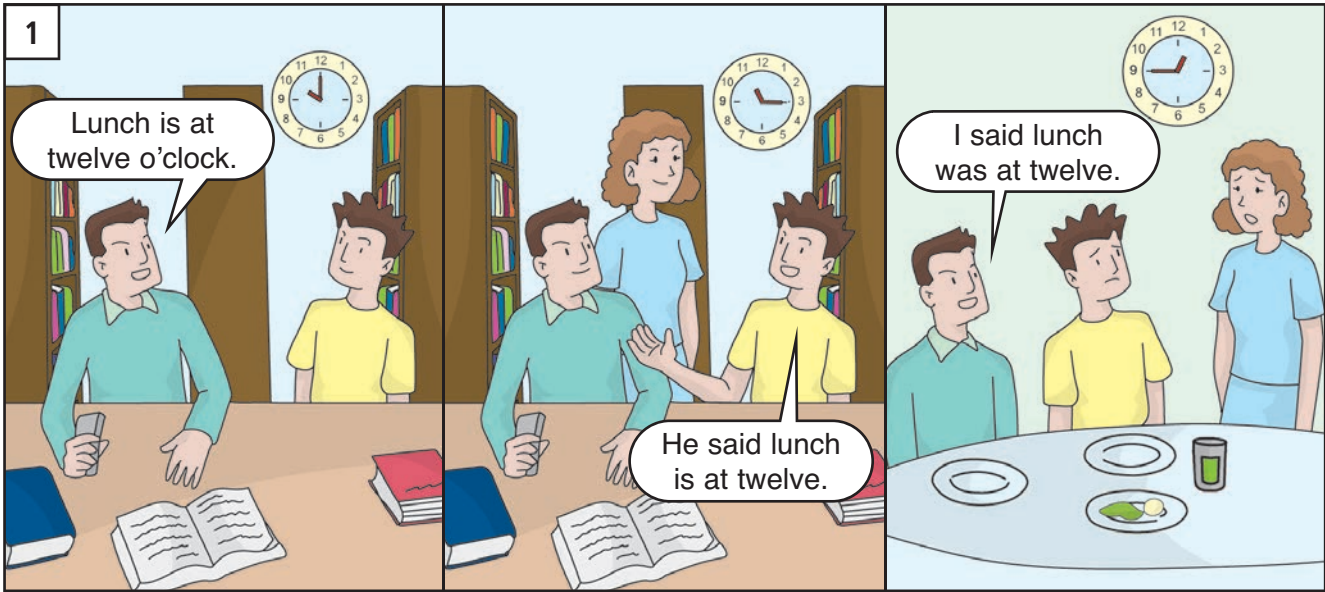

Let's check the flight number again.

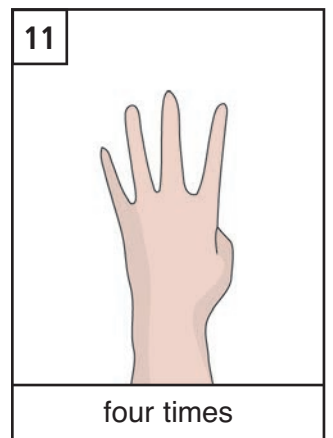
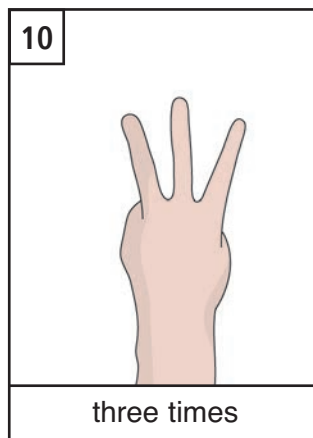
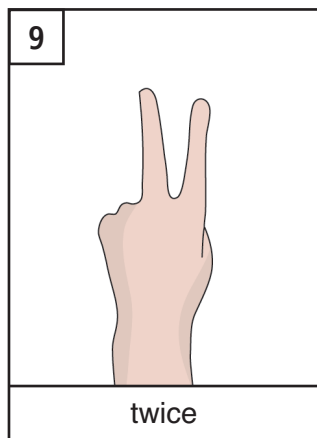
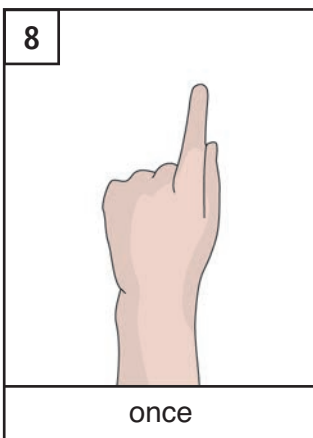
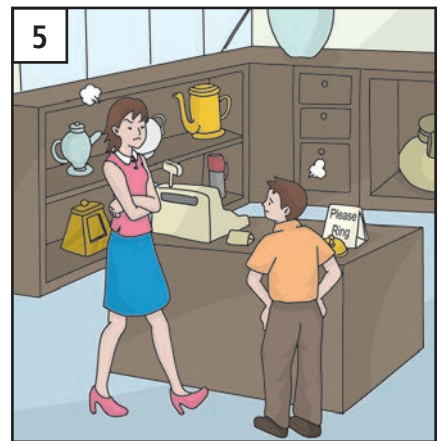

UNIT 2

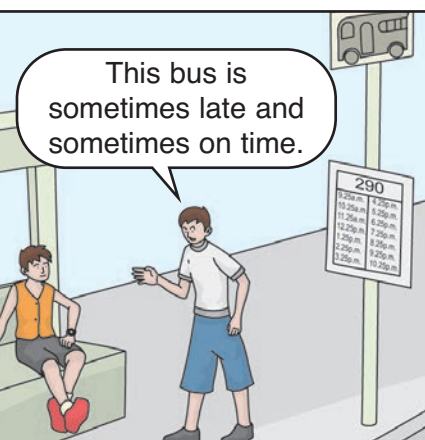
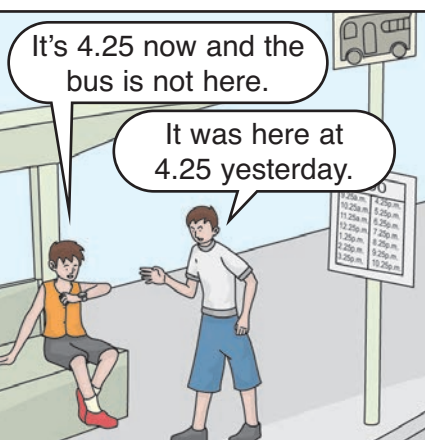
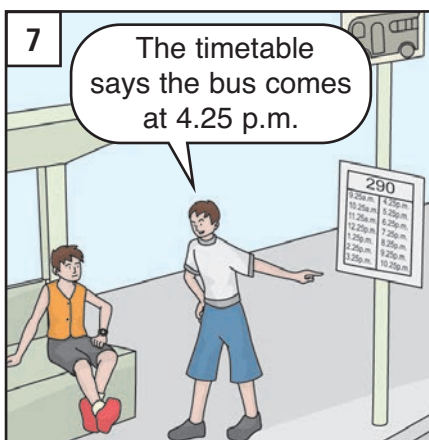
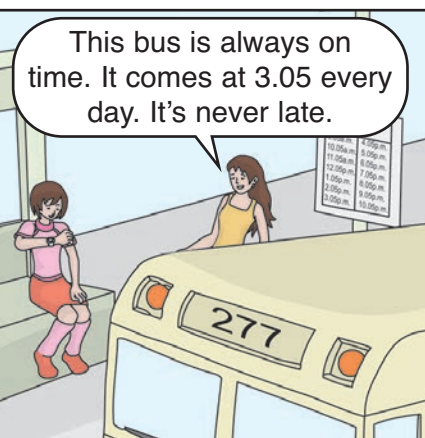
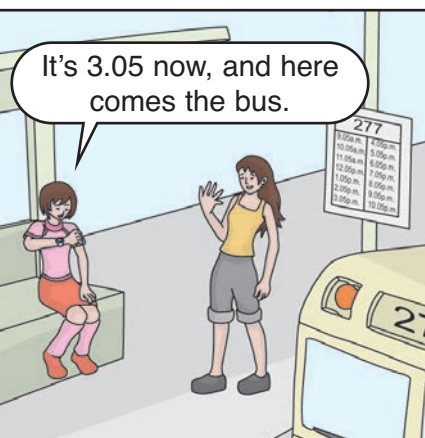
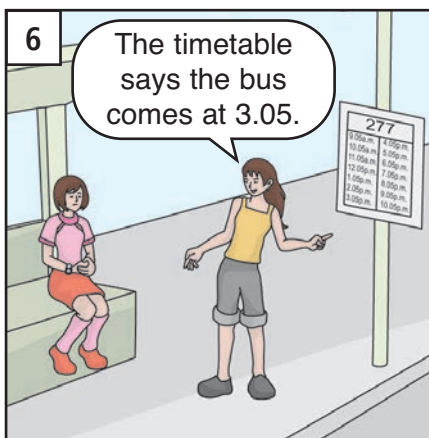
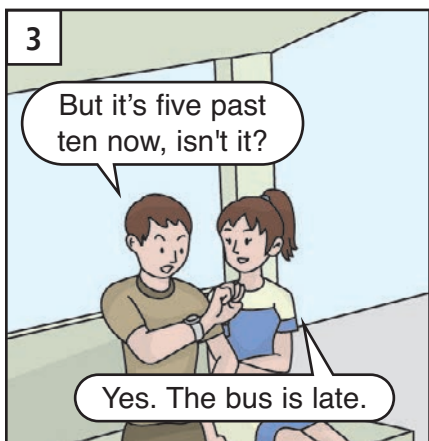
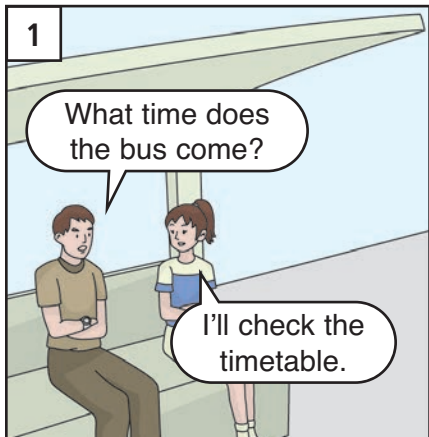

 will not = won't

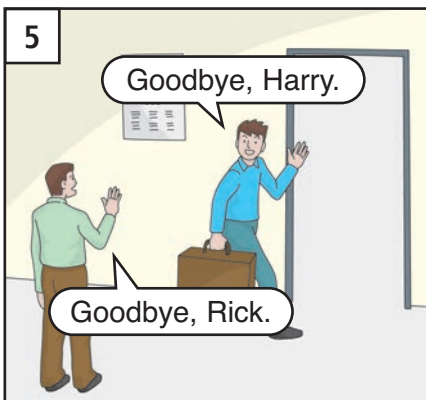
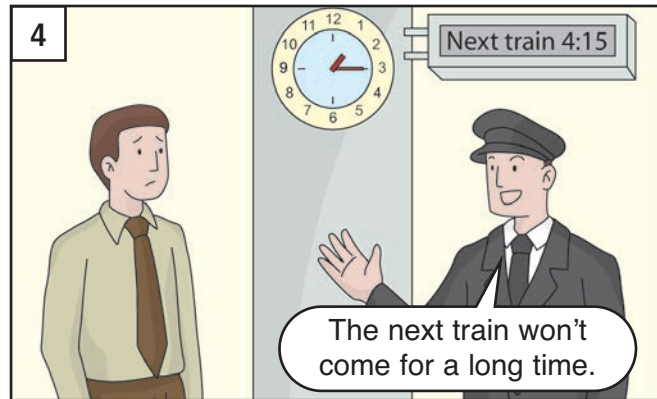
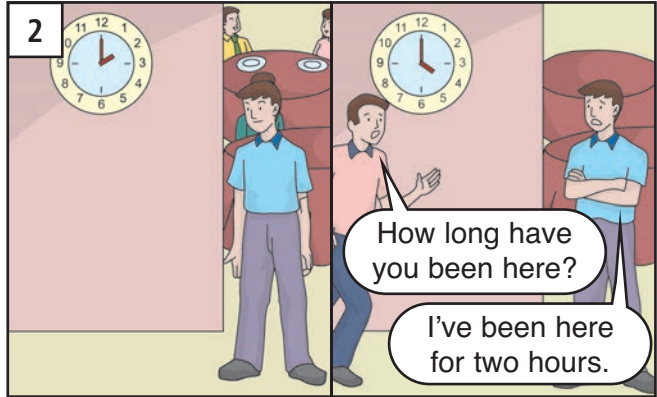
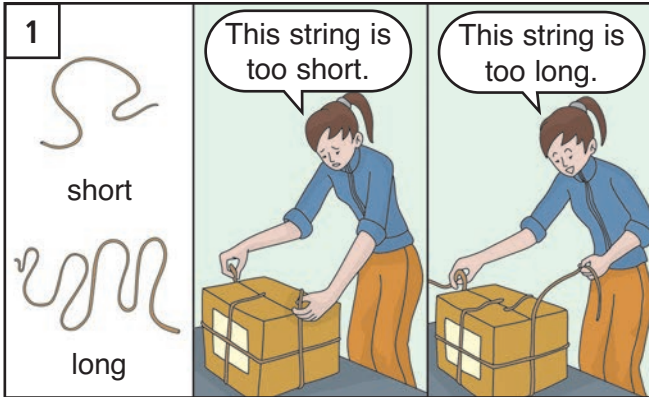

UNIT 2

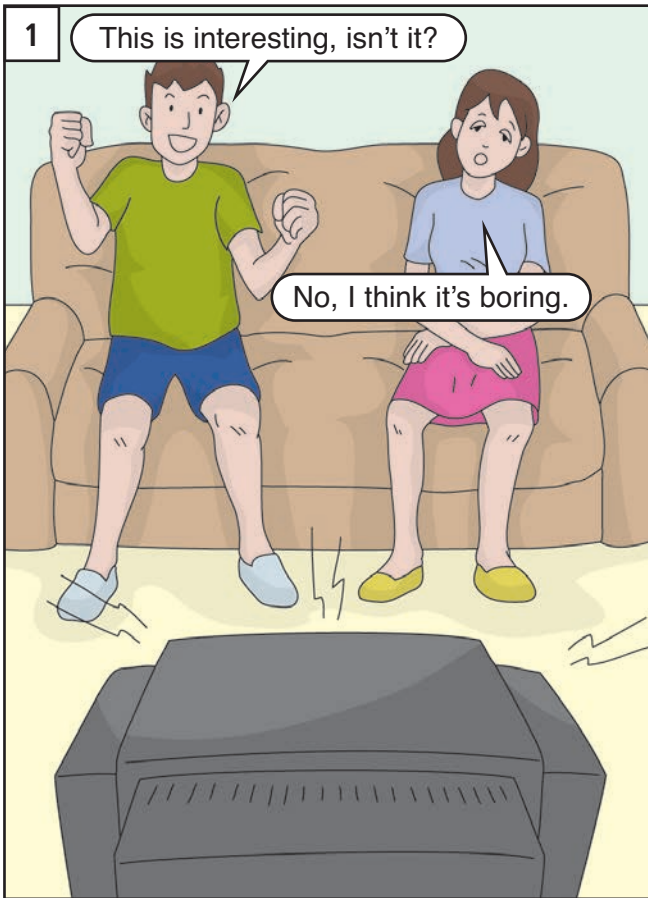

frightening



frightened



surprising

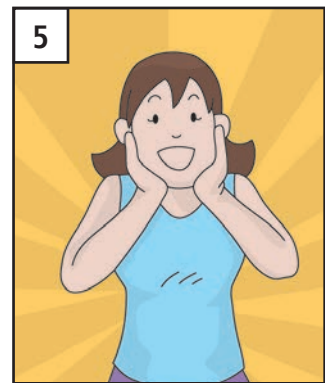

surprised



Shopping is tiring.



She is tired.

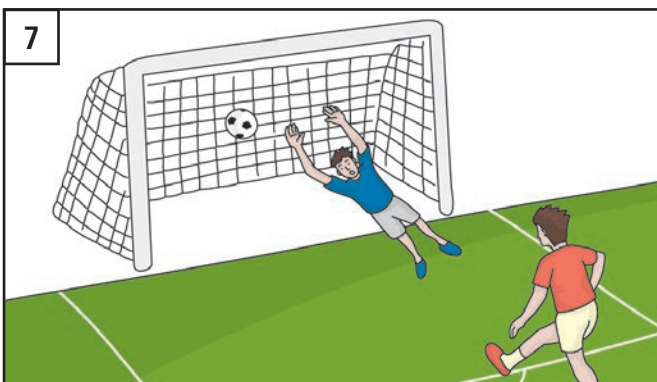

The game is exciting.

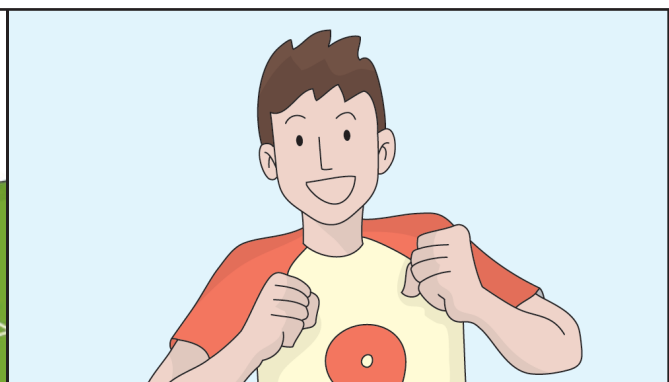

He is excited.

Let's check the flight number again.



The teacher is boring.  
The student is bored.

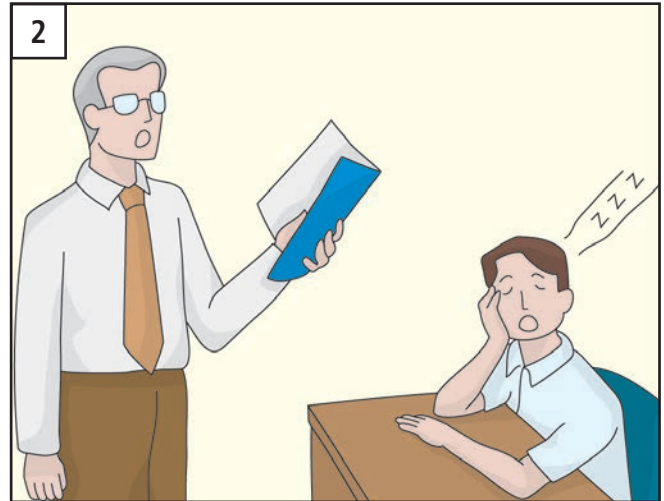

The teacher is very boring.  
The student is very bored.

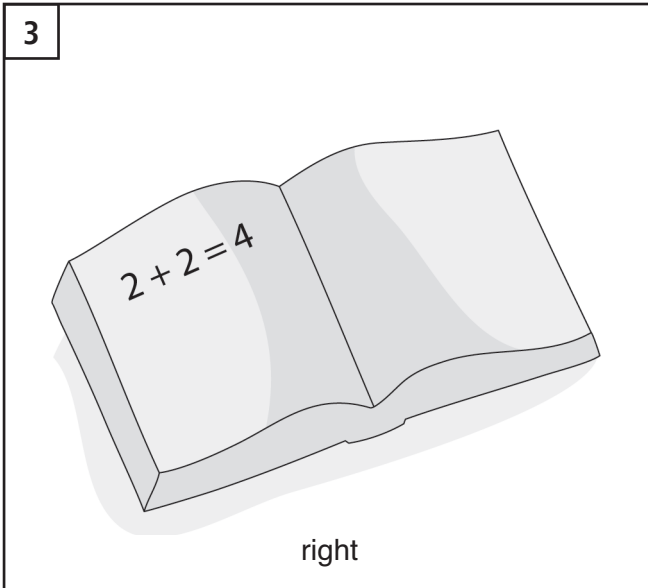

right

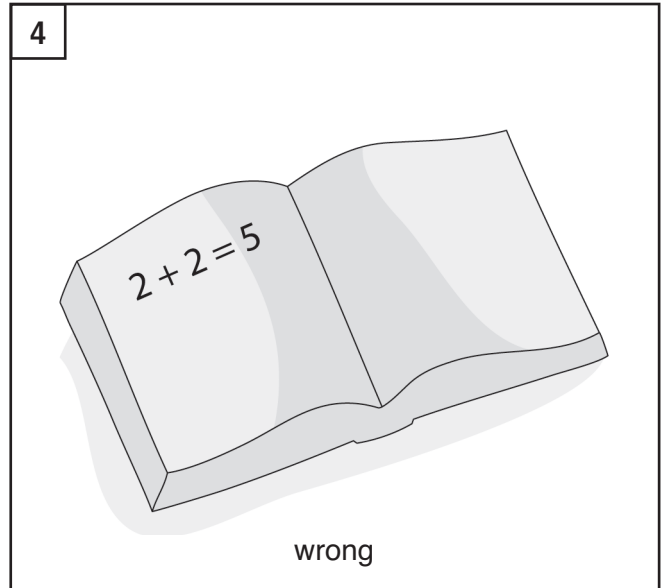

wrong



Mr Willis?

Yes, that's right.

Ken  
Willis

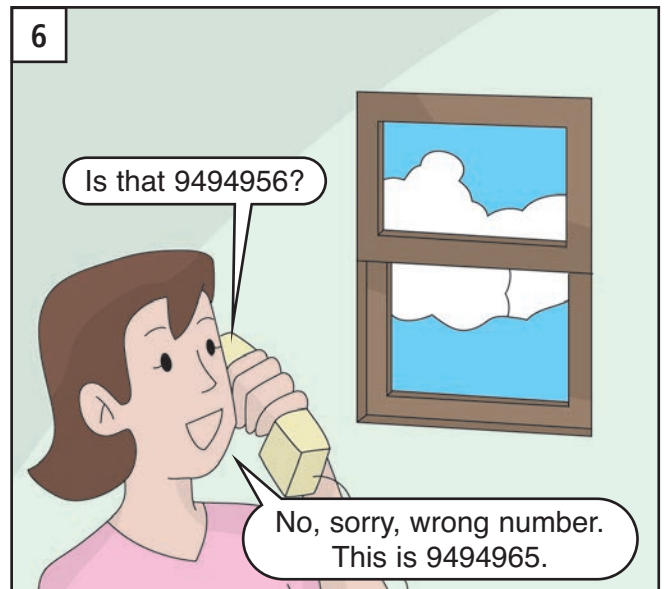

Is that 9494956?

No, sorry, wrong number.  
This is 9494965.

# The Bensons

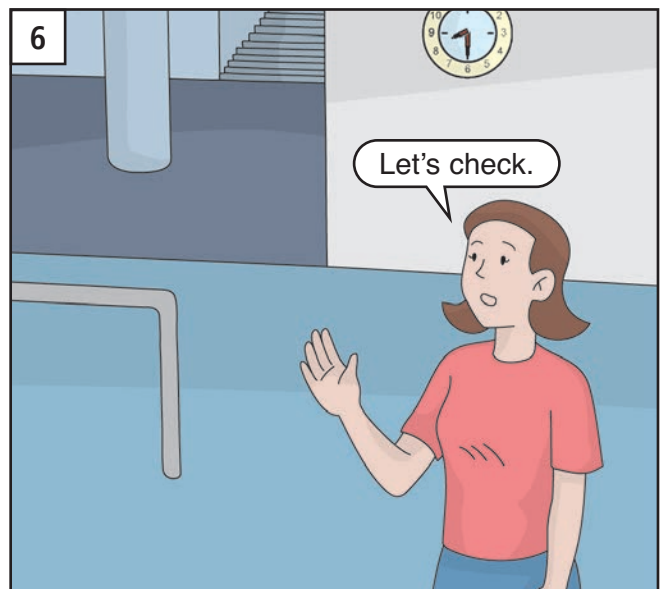

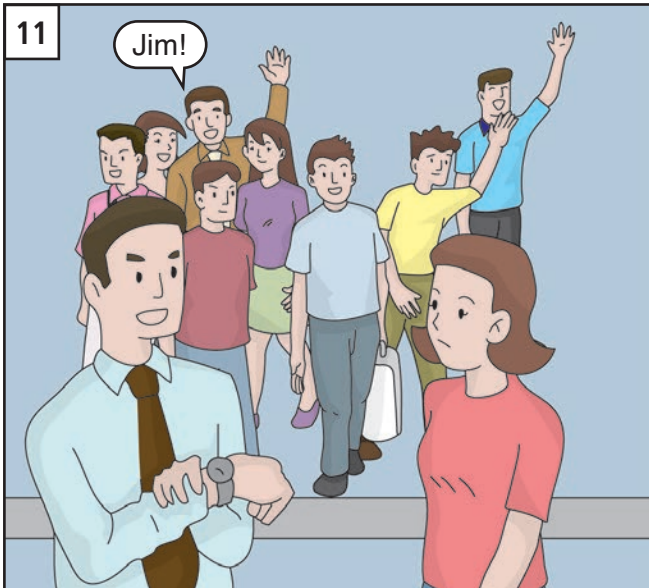
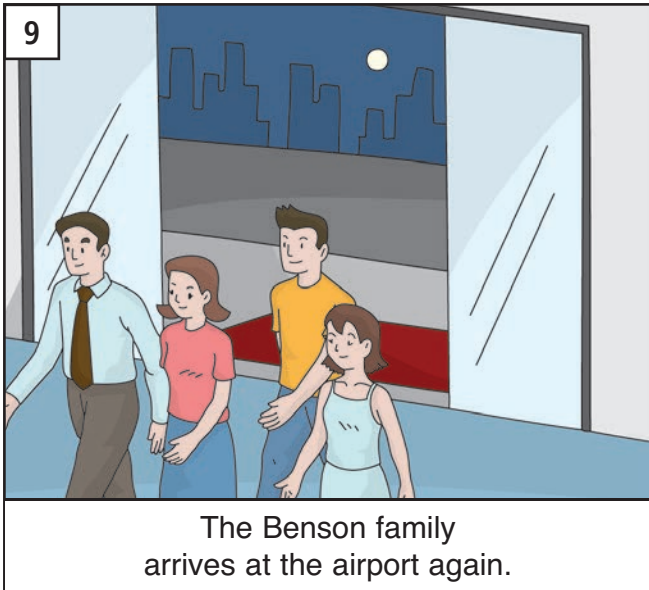
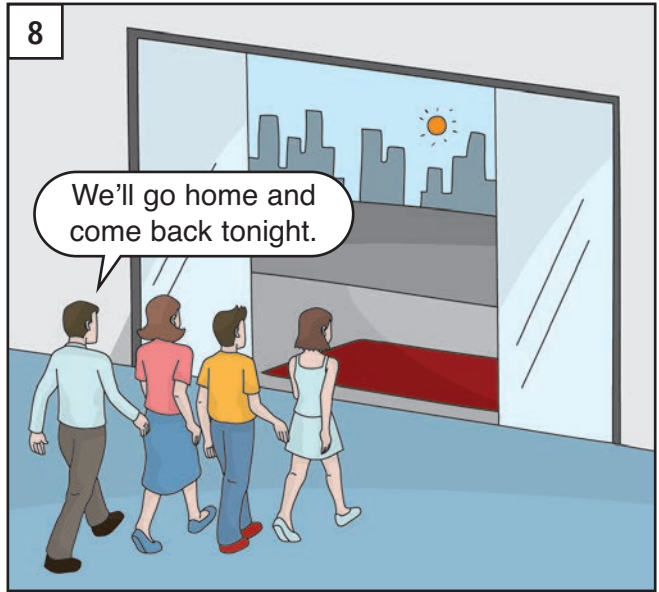

# UNIT 3: It's a goal!

half equal	share unequal	almost enough	not enough too much	garage garden balcony	shed backyard
living room bedroom single bed double bed dining room kitchen bathroom toilet upstairs downstairs	tunnel tandem	bird	goal seat	fence gate path roof	
	lots of			there are	there is
	front		back	through into out of	with without
	tidy		mess		
money		another		hamburger	sauce

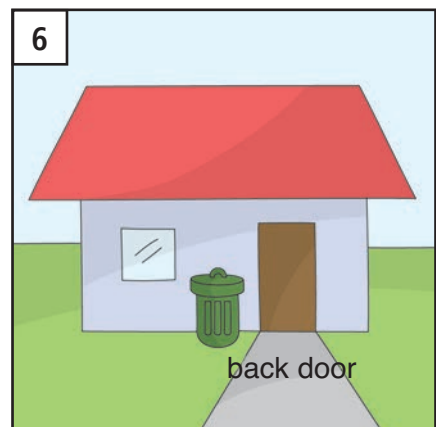
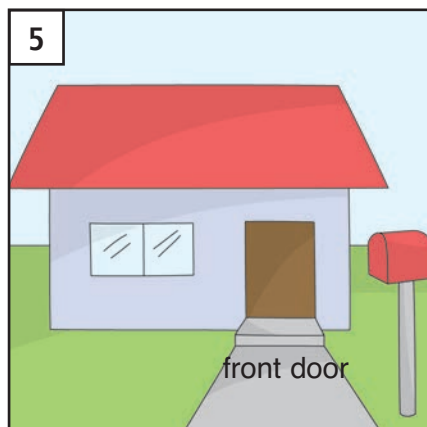
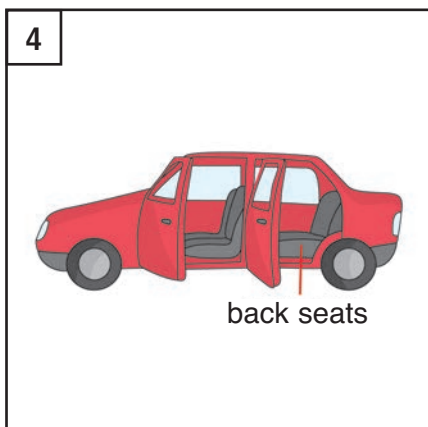
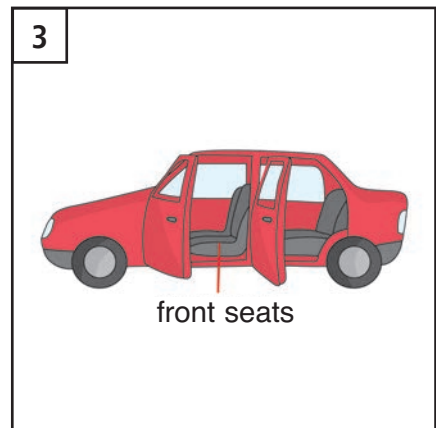
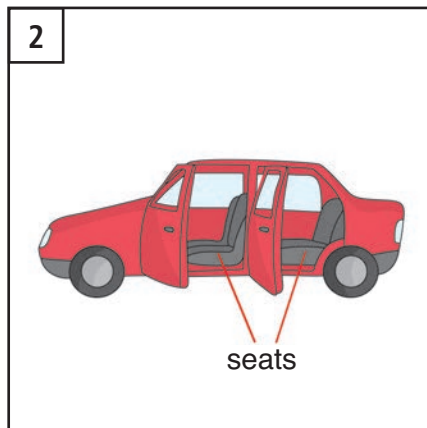
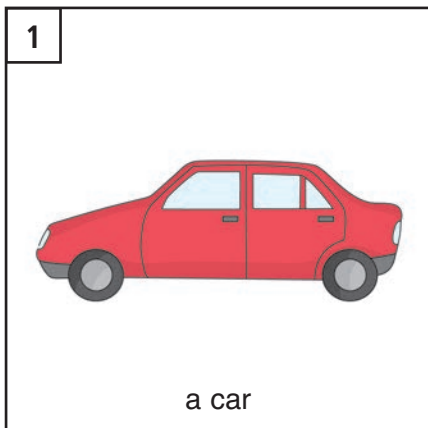

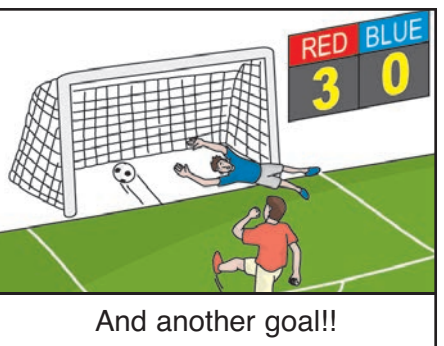
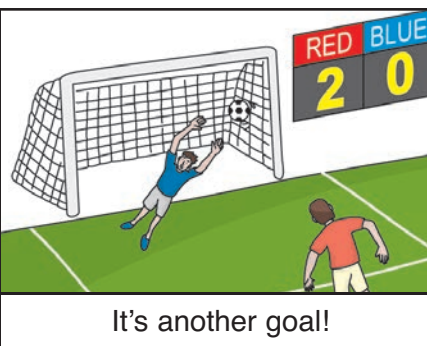
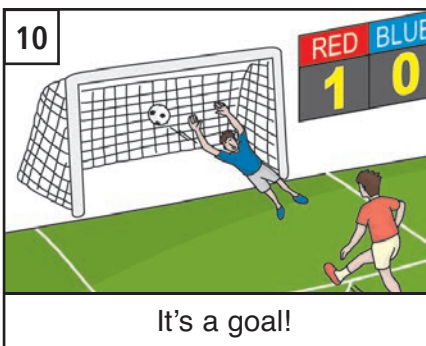
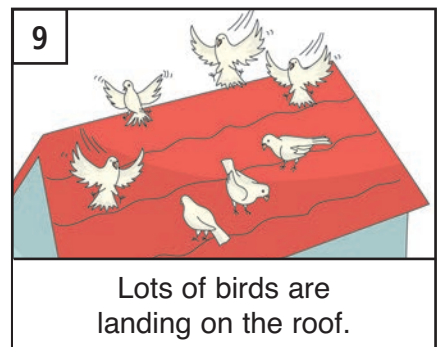
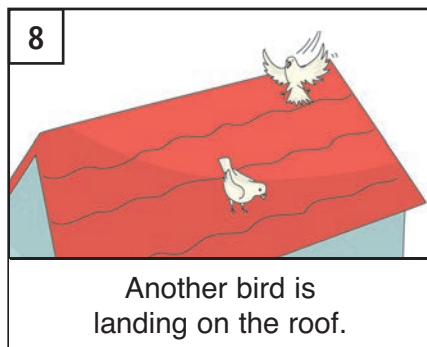
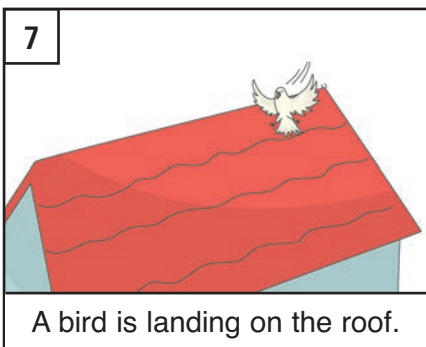
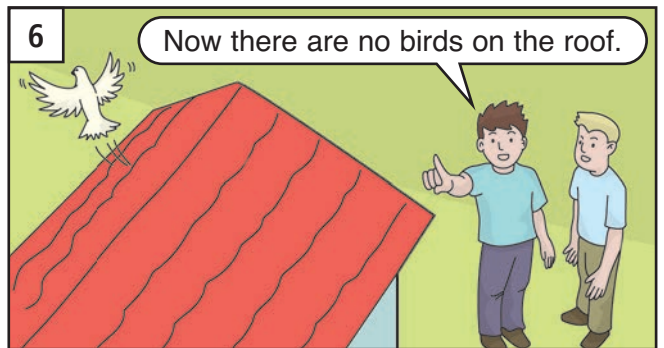
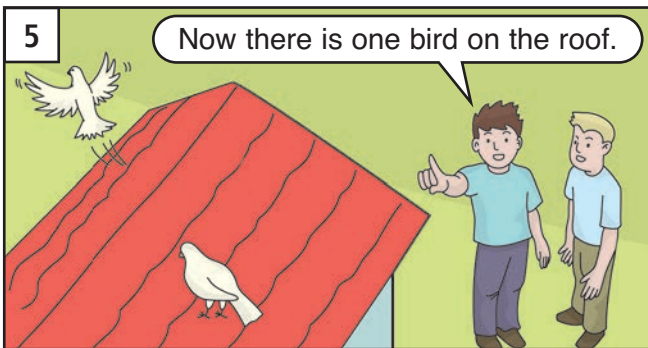
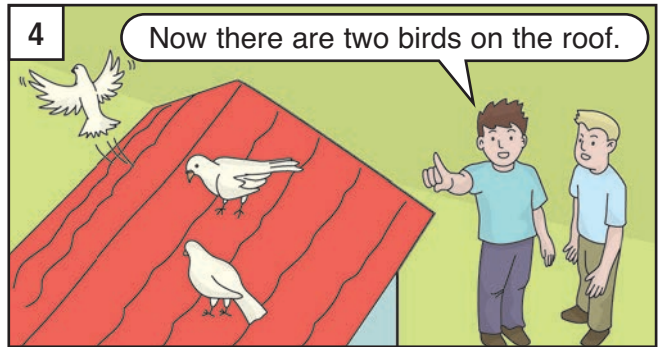
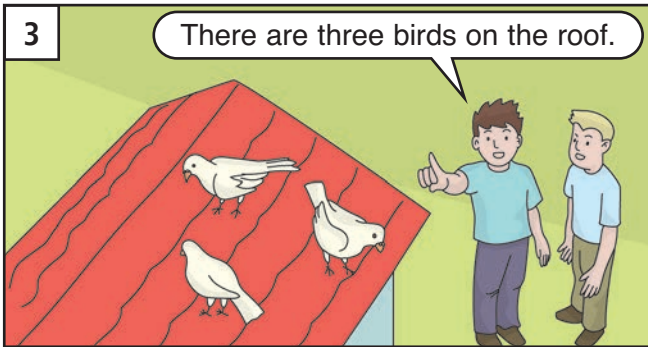
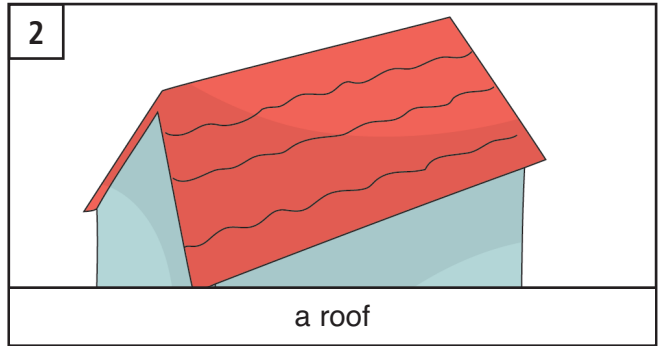
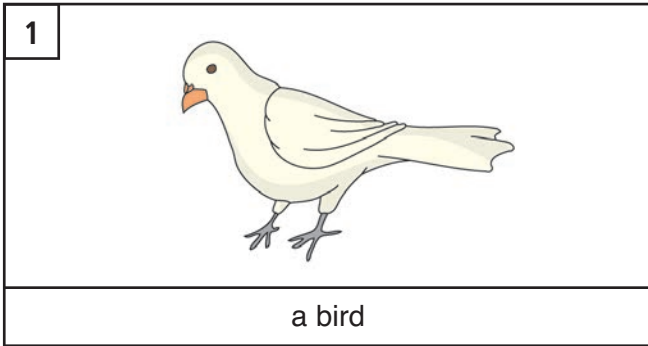

UNIT 3

1

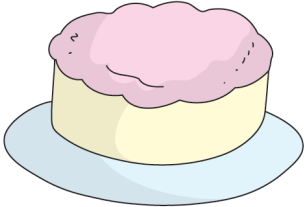

one cake

2

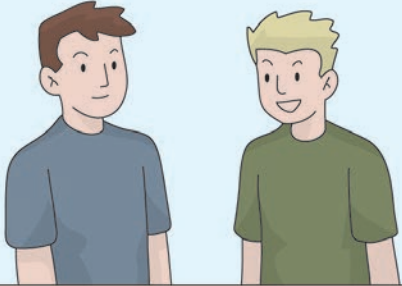

two boys

3



share the cake

4

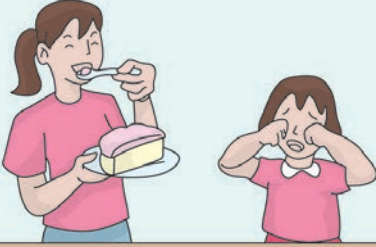

Share the cake with your sister.

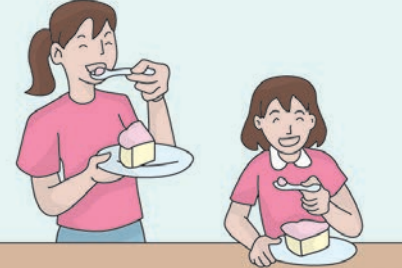

half each

5



half



half each

6

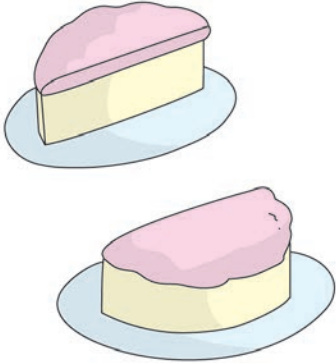





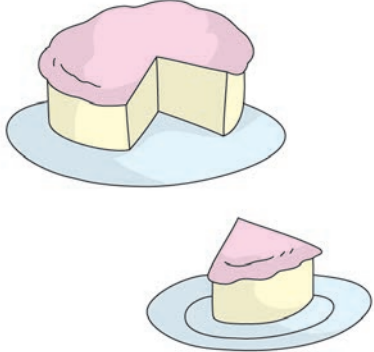

equal

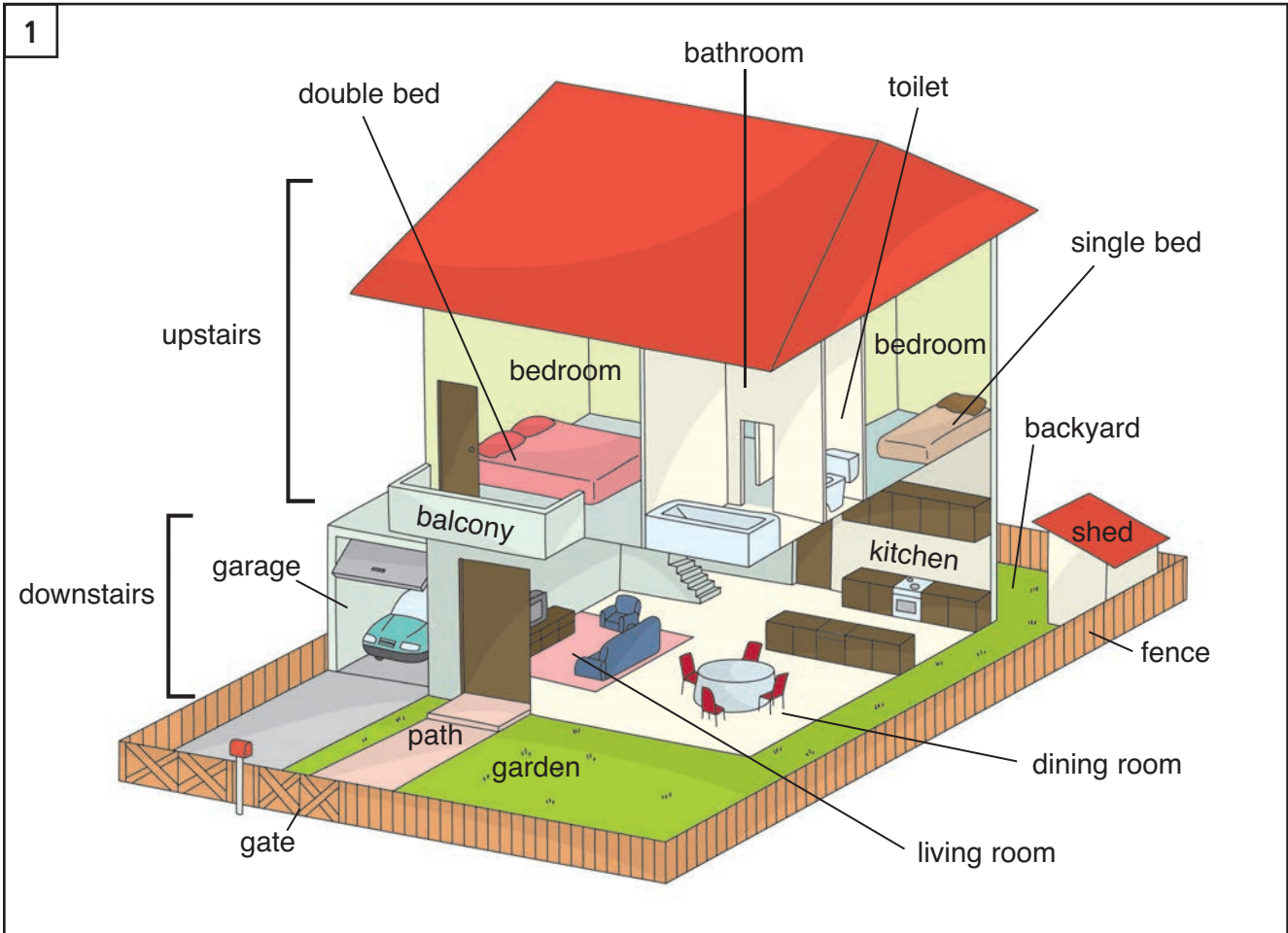

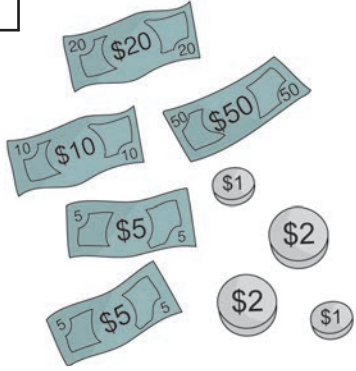
7



unequal

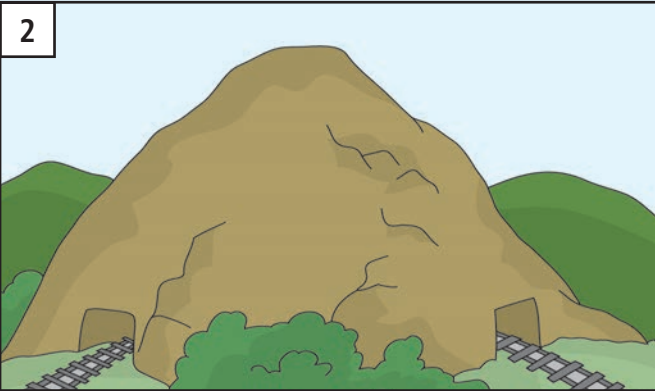

<p>1</p>  <p>money</p>	<p>This watch costs \$50.00.</p>  <p>This is enough money.</p> 	 <p>Not enough money.</p>
 <p>Almost enough money.</p>	 <p>Too much money.</p>	 <p>Here's your change.</p> <p>Not enough change.</p>

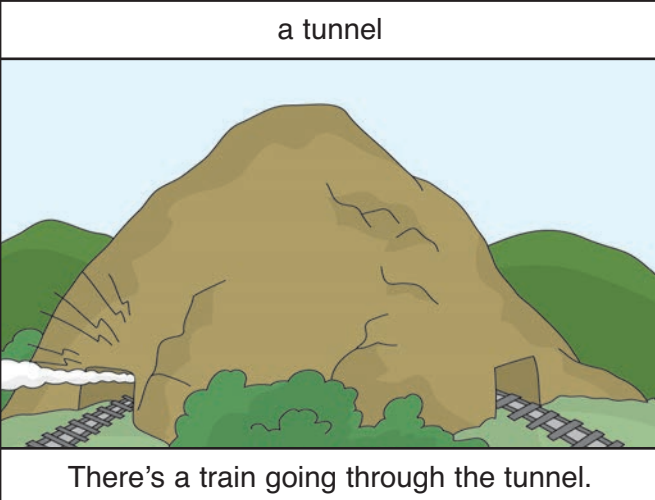
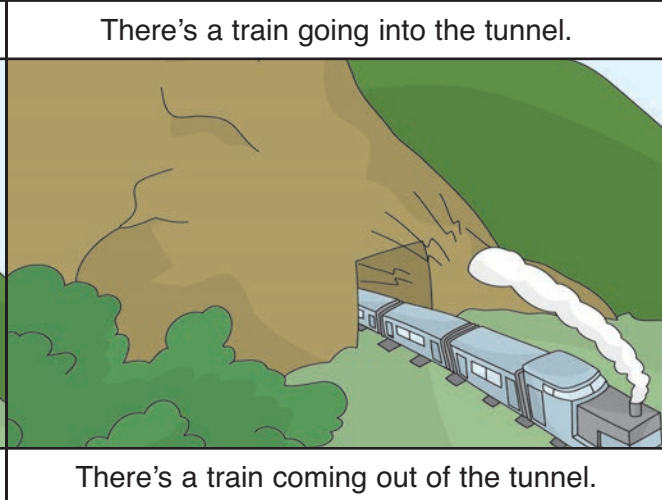
<p>2</p>  <p>a tunnel</p>	 <p>There's a train going into the tunnel.</p>
 <p>There's a train going through the tunnel.</p>	 <p>There's a train coming out of the tunnel.</p>

1

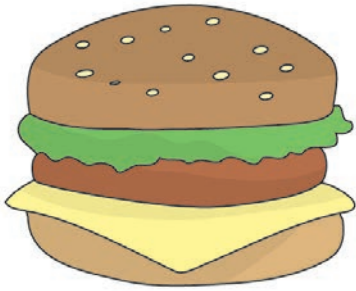

a hamburger

2

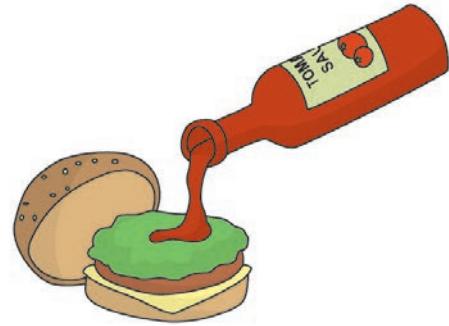

a hamburger with sauce

3



tea

4

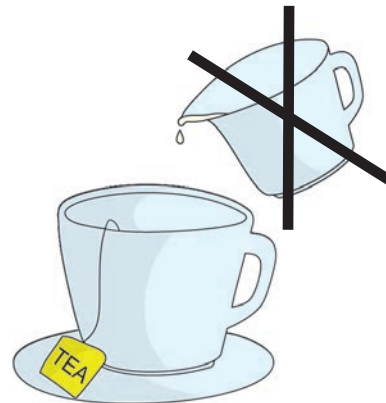

tea without milk

5

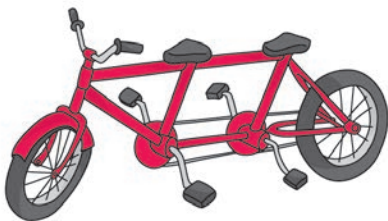

a tandem

6



with his friend

7



without his friend

# The Bensons

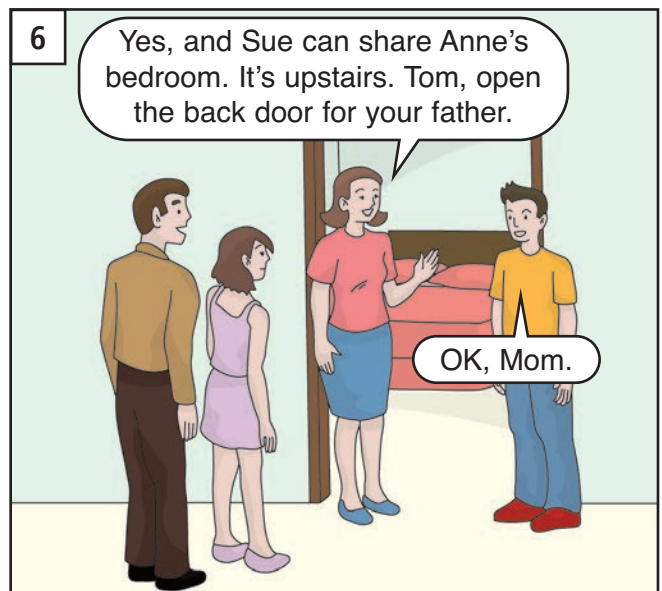
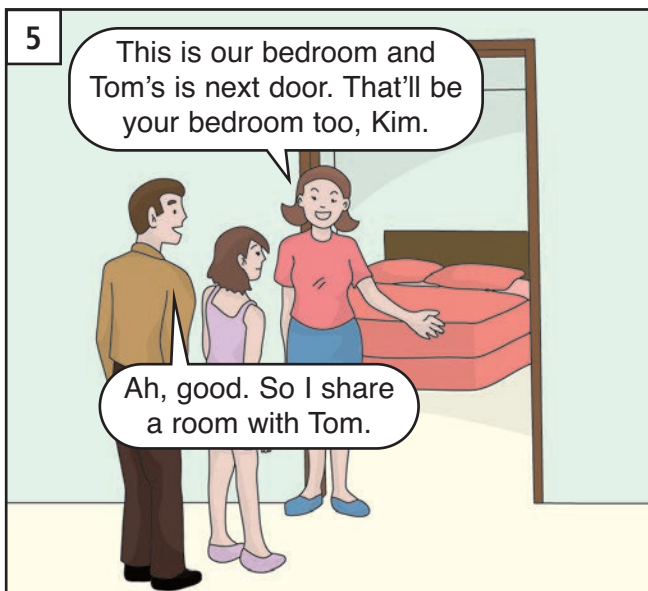
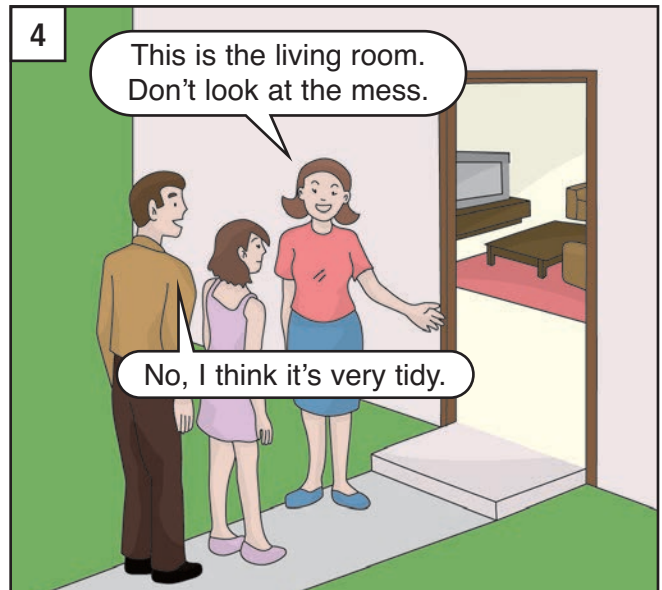
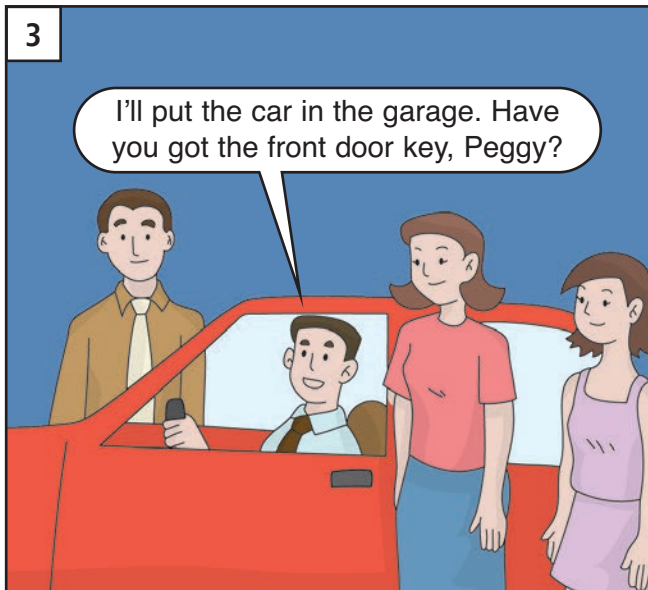
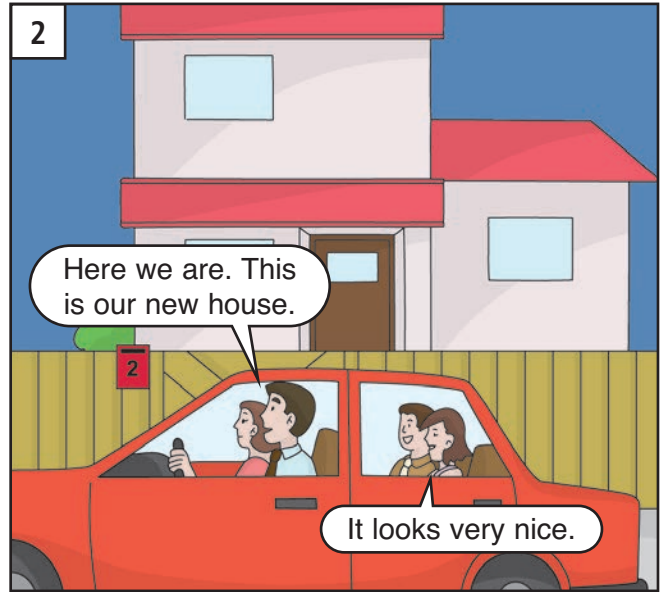
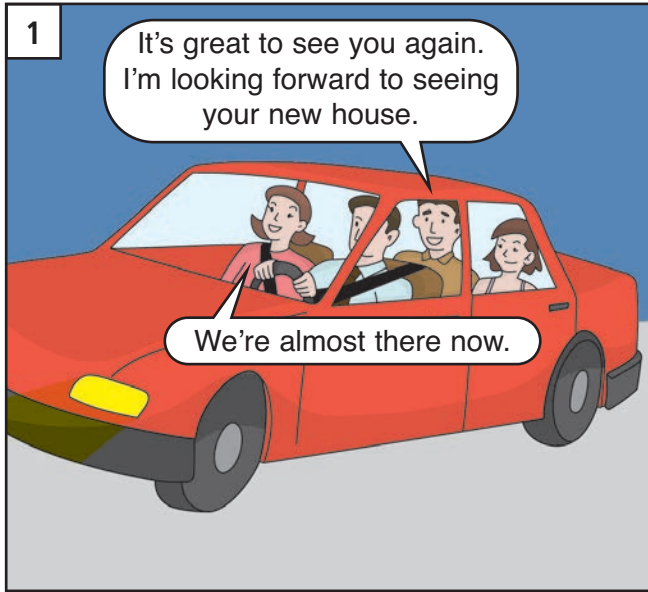

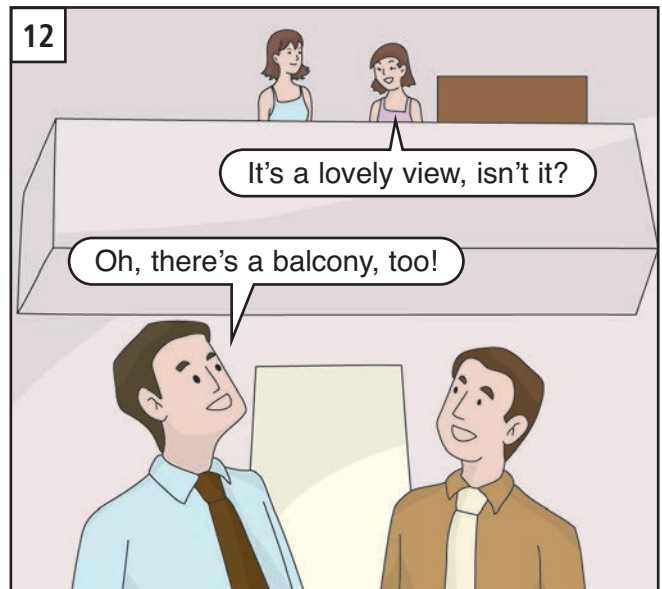
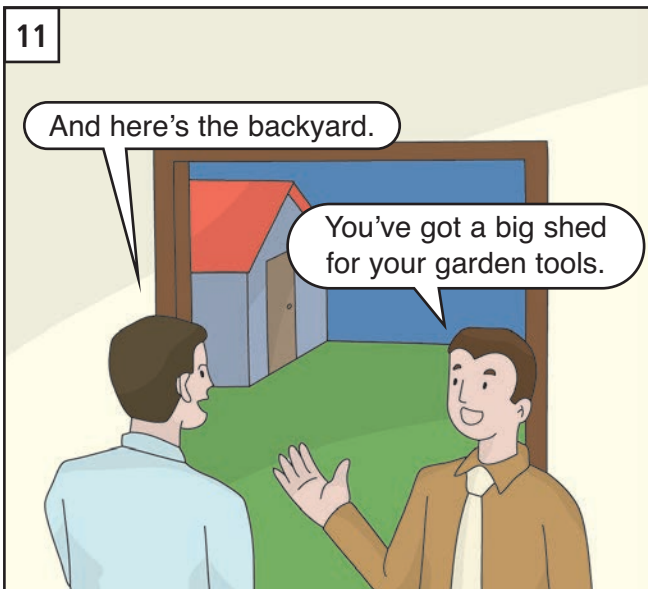
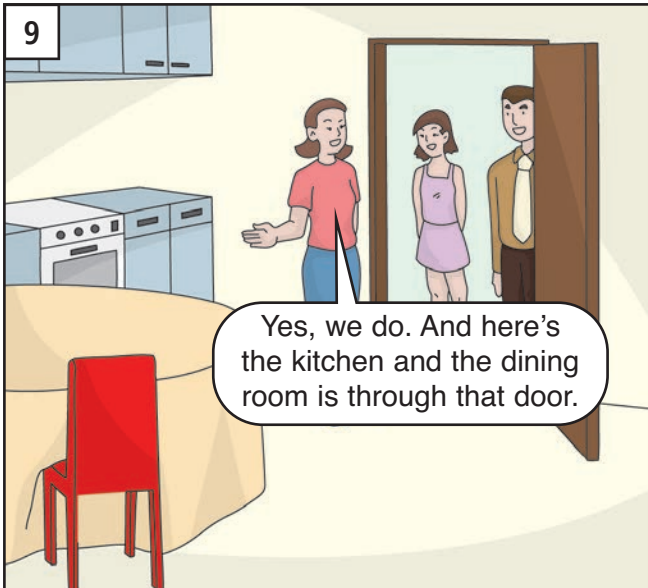
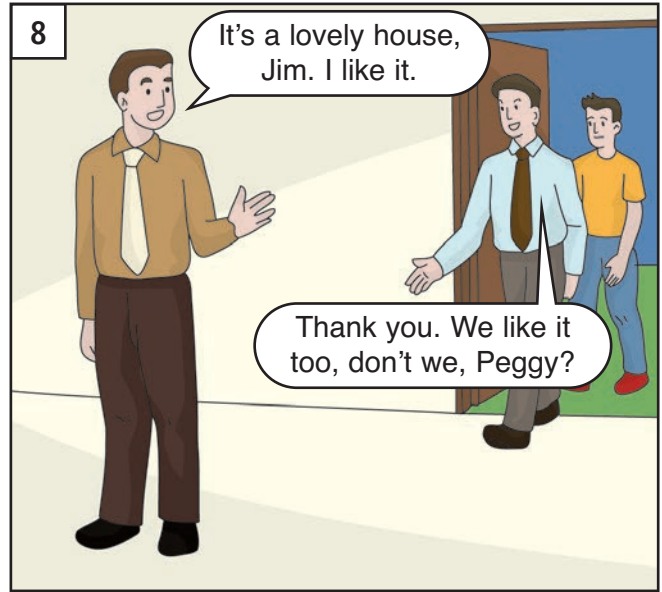

# UNIT 4: I want a chocolate bar!

birthday  
anniversary

excellent

around  
around here

walk

while

chocolate bar

stars  
world  
trip  
zoo

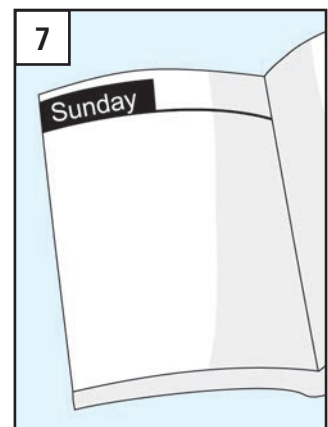
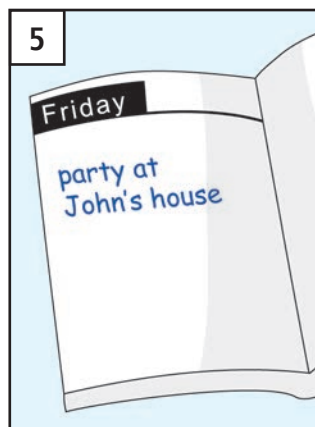
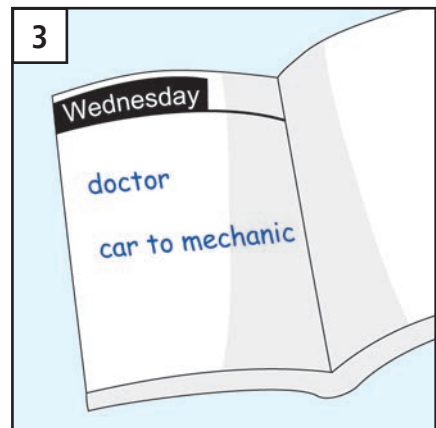
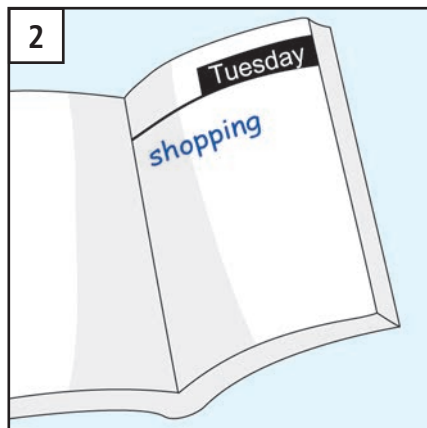
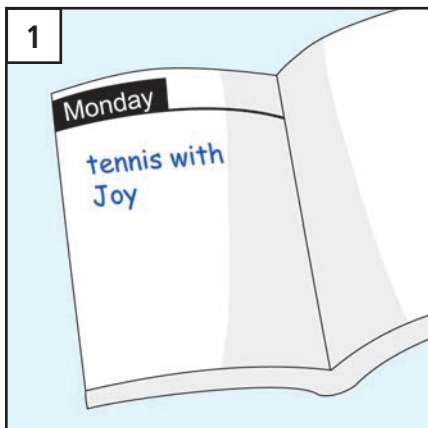



I'm very busy this week. On Monday I'm playing tennis with Joy. On Tuesday I'm going shopping. On Wednesday I'm seeing the doctor and taking the car to the mechanic. On Thursday I'm going to the art gallery with Alison. On Friday I'm going to a party at John's house. And on Saturday I'm writing some letters and working in the garden.



2 What are you doing on Sunday?



3 I don't know. I think I'll sleep all day!

UNIT 4

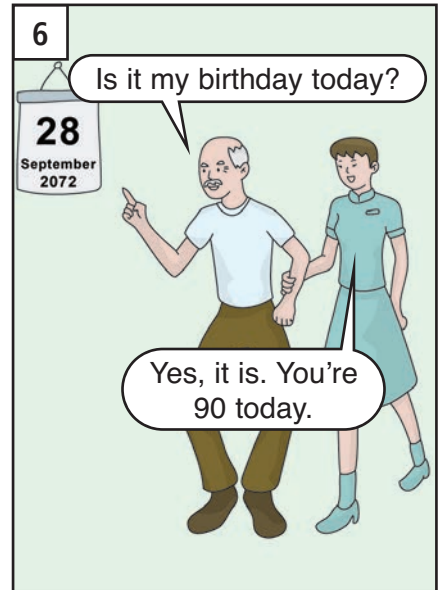

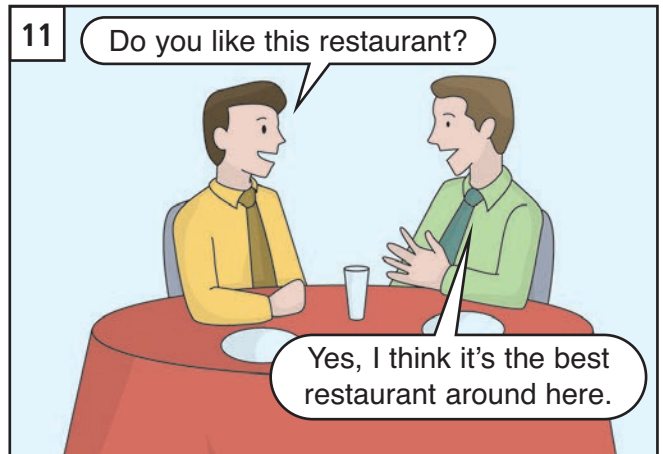
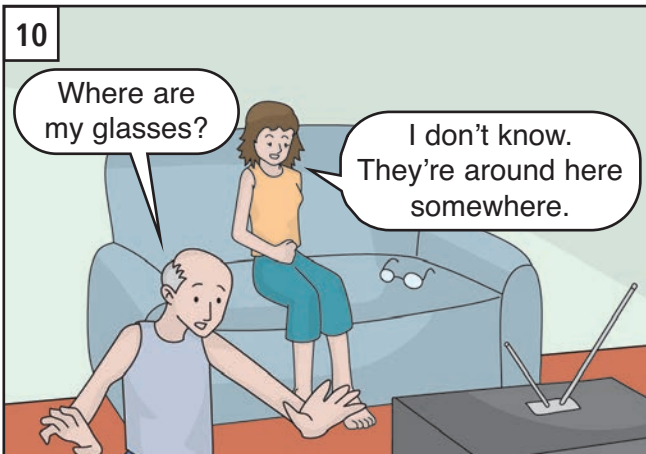
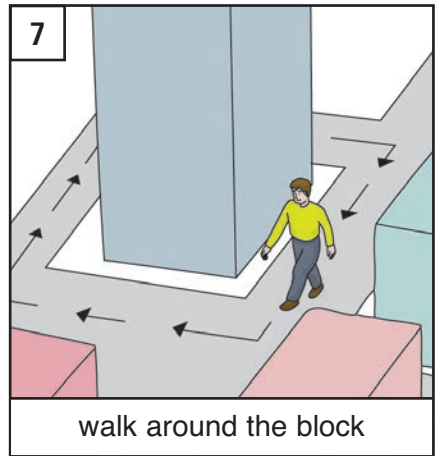
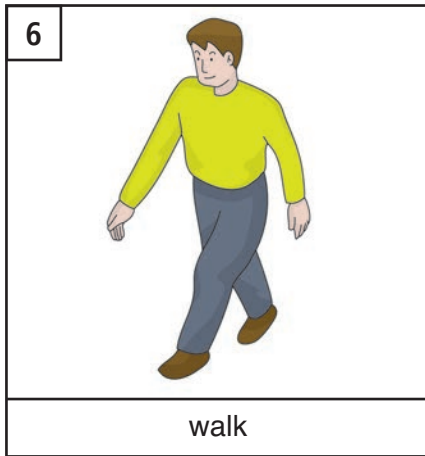
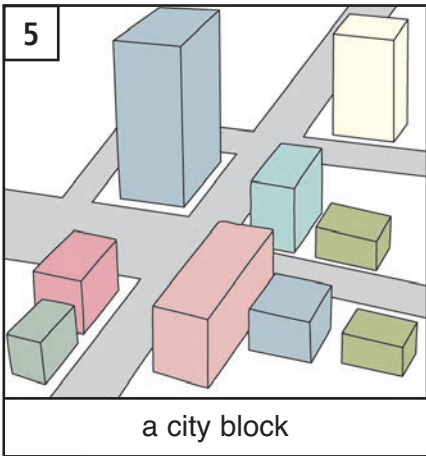
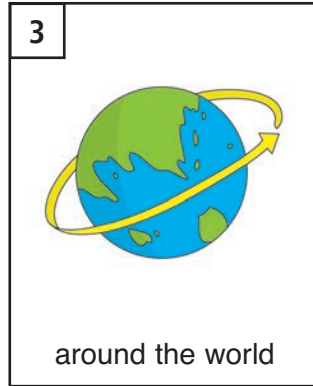
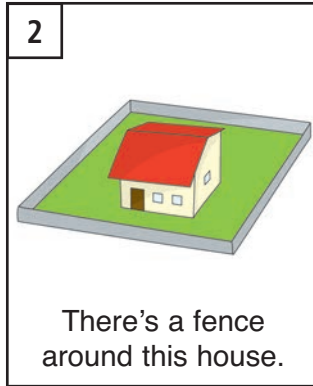
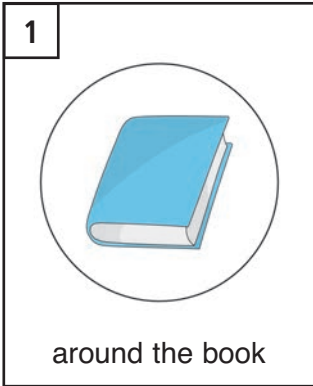

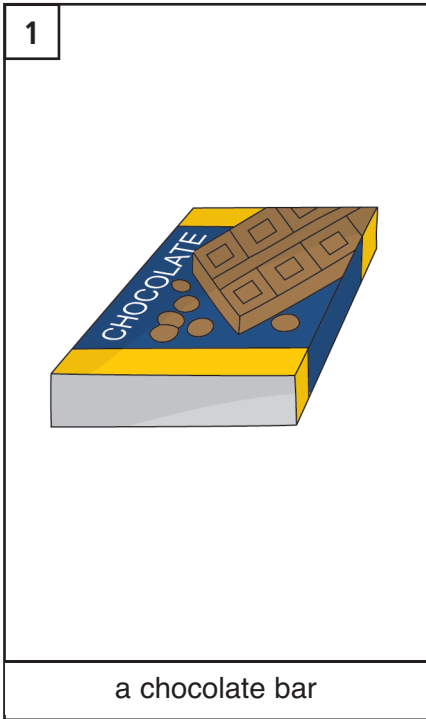

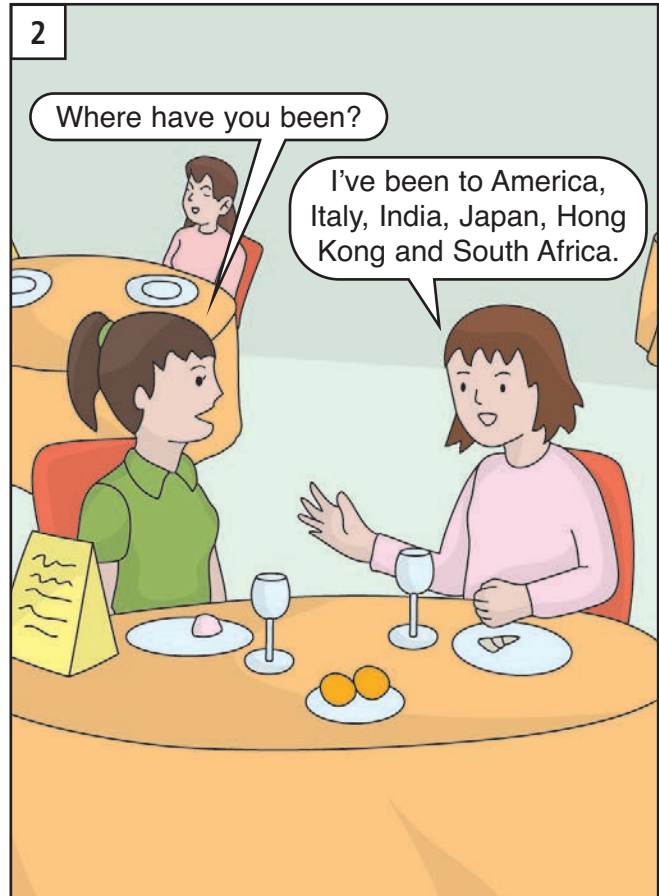

<p>1</p> <p>2001 - 2004</p>	<p>2005</p> <p>I was in Hawaii from 2001 to 2004.</p> <p>I was in Alaska from 2001 to 2004.</p>
<p>So you were in Alaska while I was in Hawaii?</p> <p>Yes. What did you do while you were in Hawaii?</p>	<p>I worked in a restaurant. What did you do while you were in Alaska?</p> <p>I worked in a restaurant, too.</p>

<p>2</p> <p>What is the best hotel around here?</p>	<p>This hotel is good.</p>
<p>This hotel is very good.</p>	<p>This hotel is excellent.</p>

# The Bensons

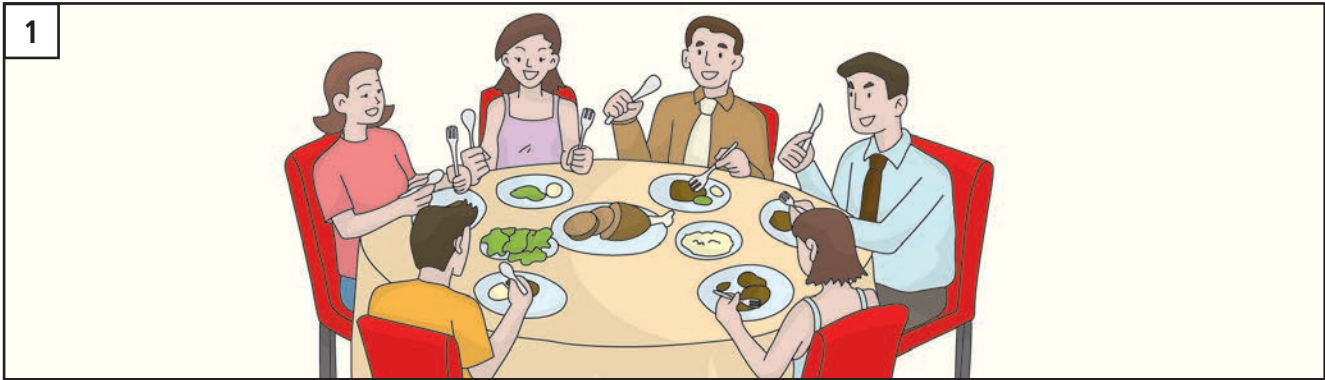

The Benson's are having dinner with their guests, Kim and Sue.

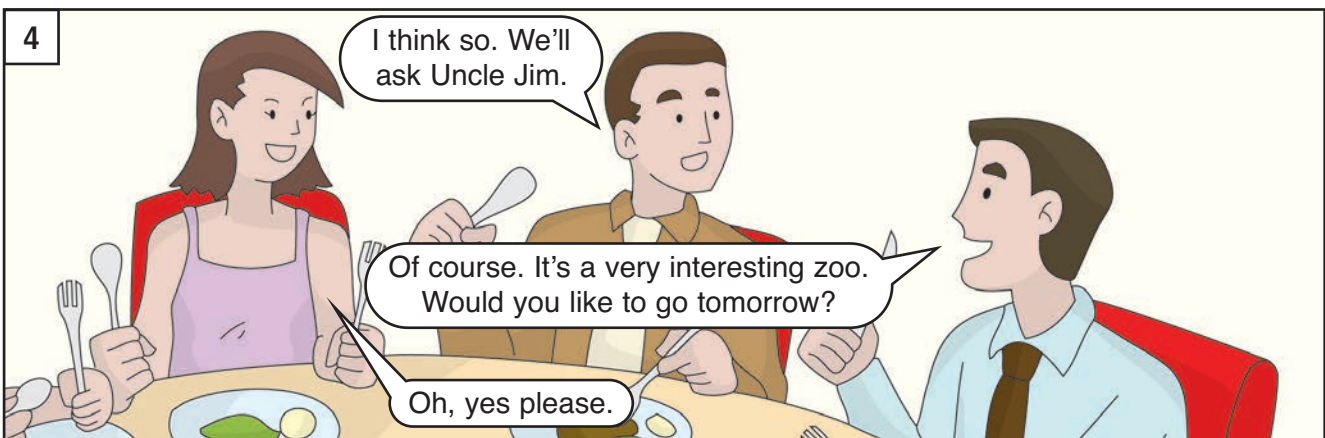
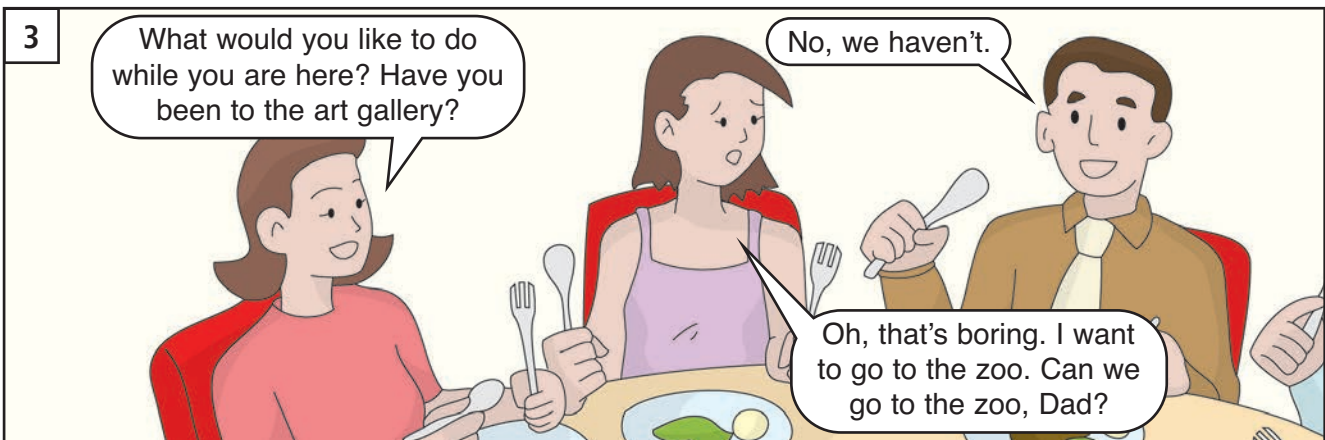
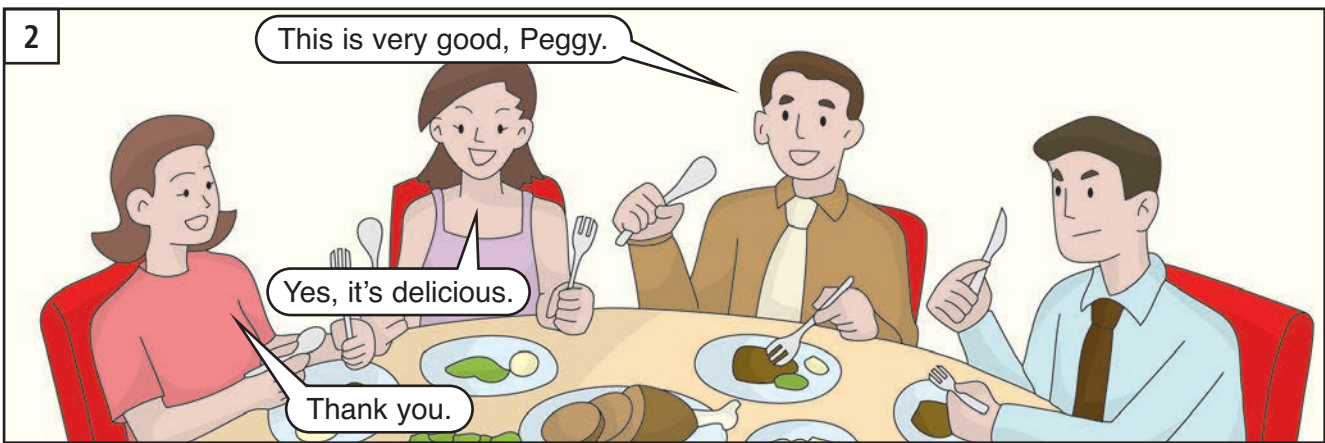

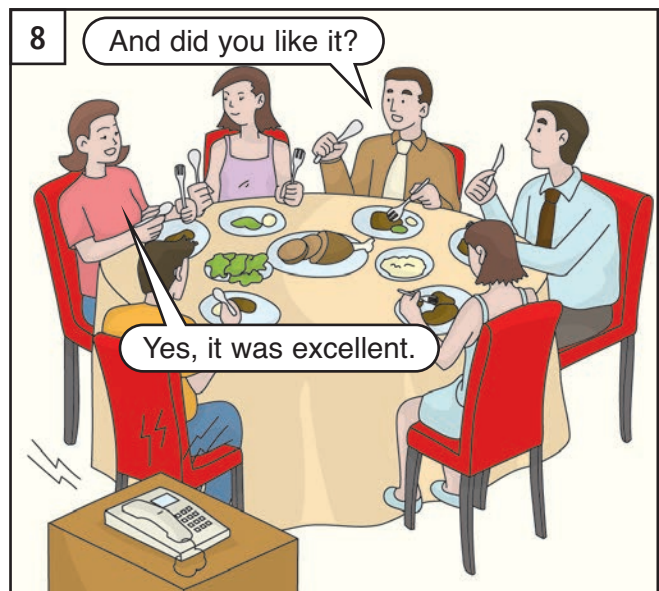
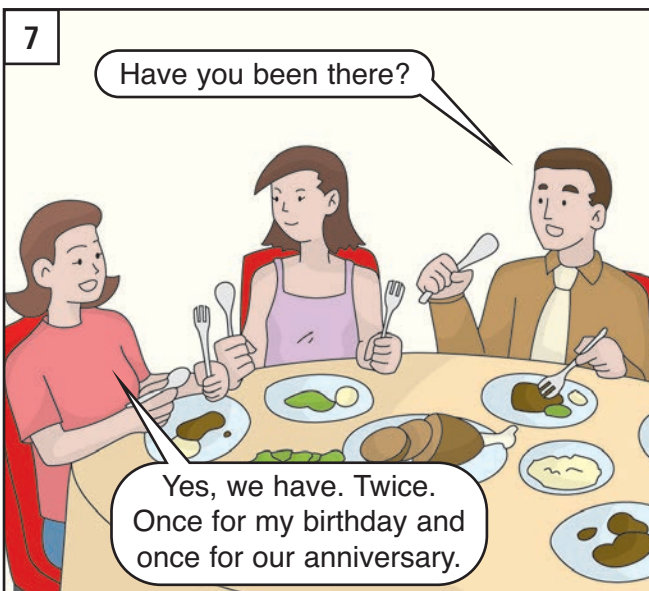
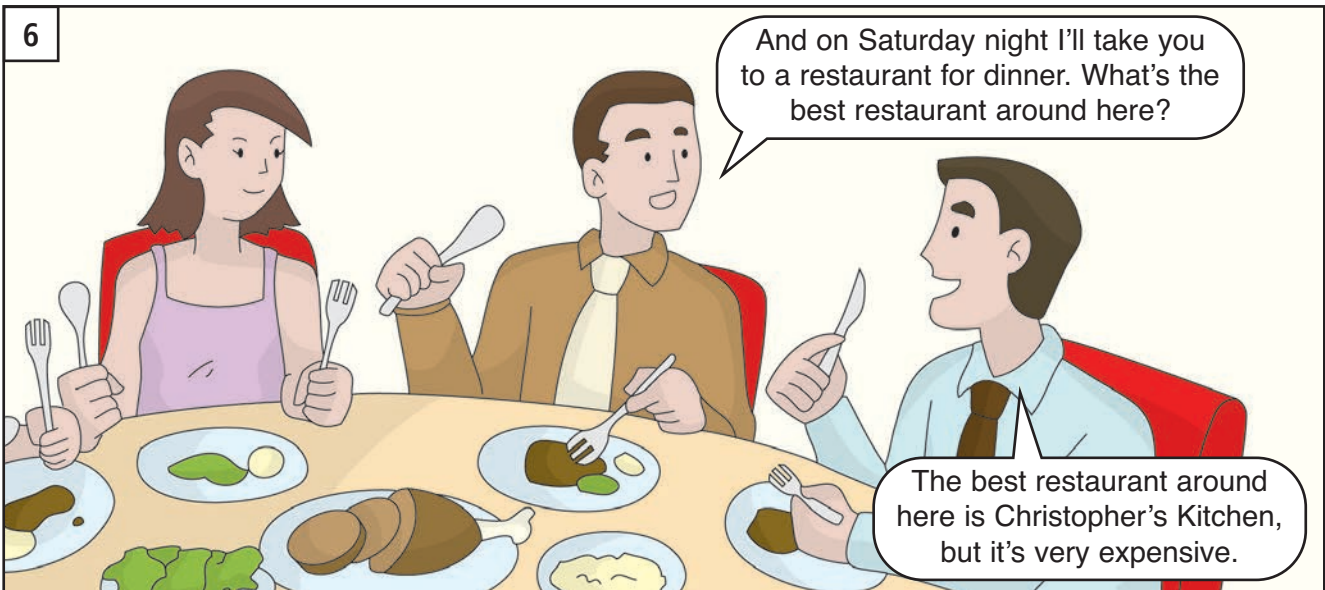

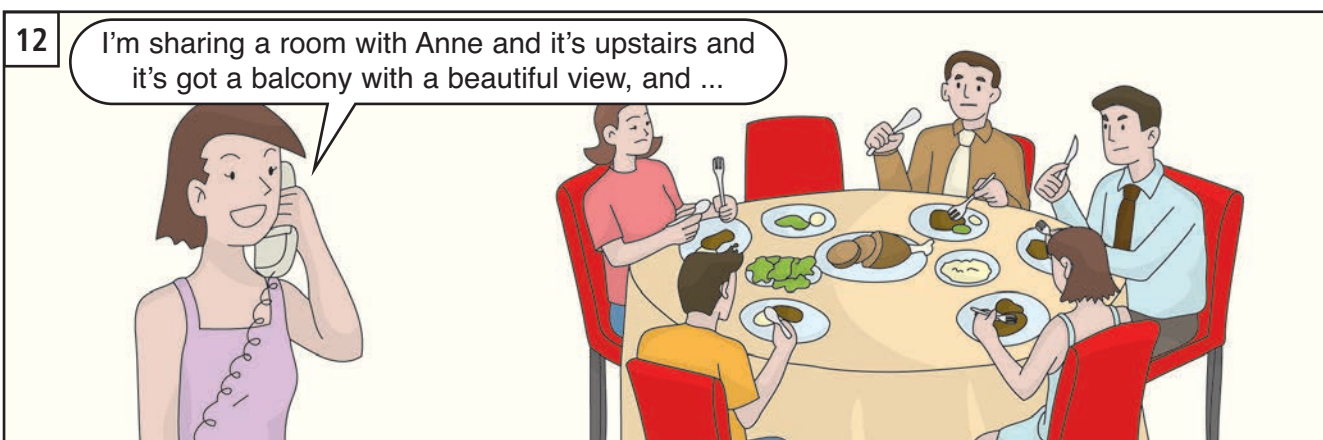
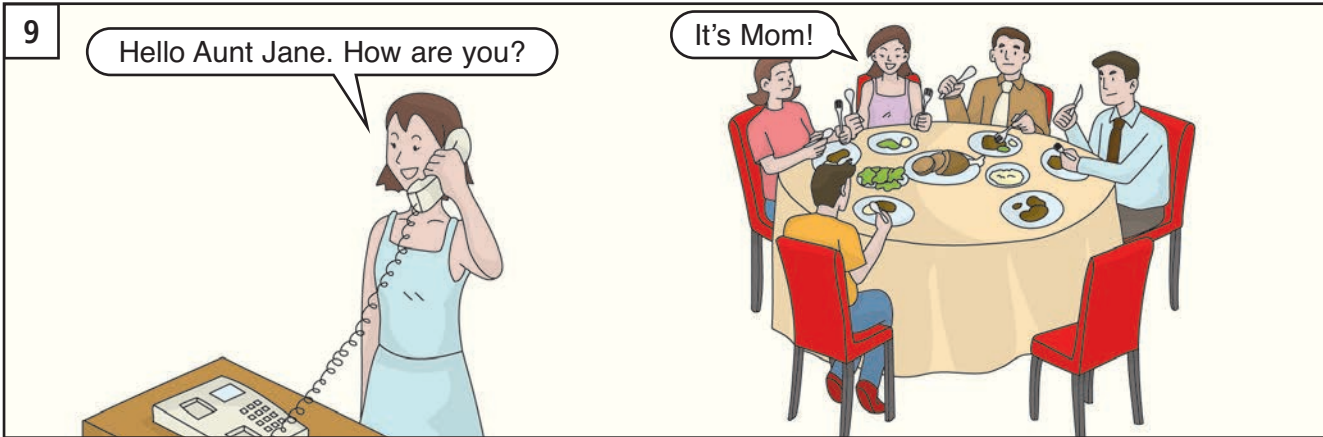

# UNIT 5: Revision and extension

1

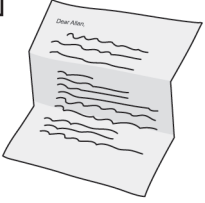

letter

.....

2



.....

3



.....

4

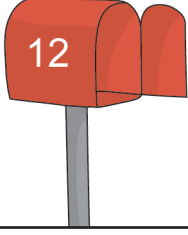

.....

5



.....

6



.....

7



.....

8

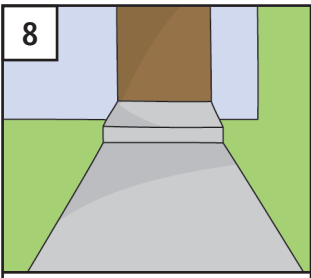

.....

9

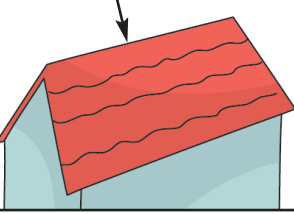

.....

10



.....

11

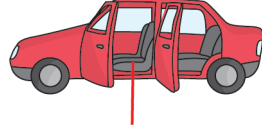

.....

12

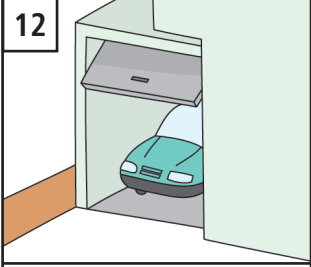

.....

13

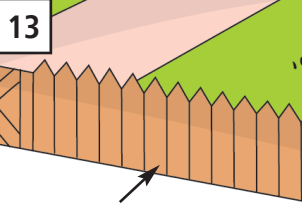

.....

14

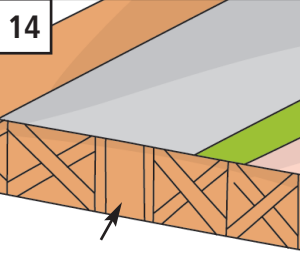

.....

15

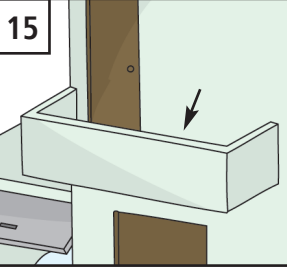

.....

16

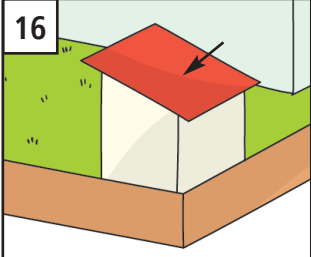

.....

17

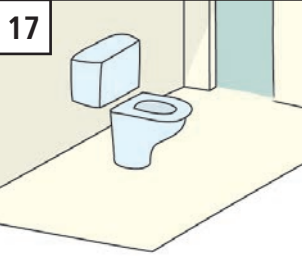

.....

18

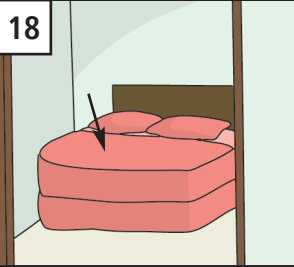

.....

19

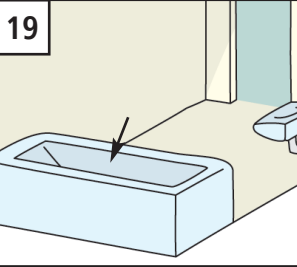

.....

20

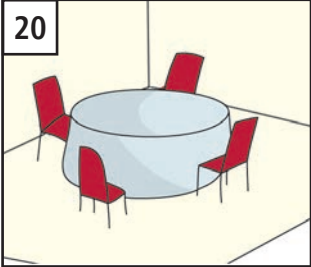

.....

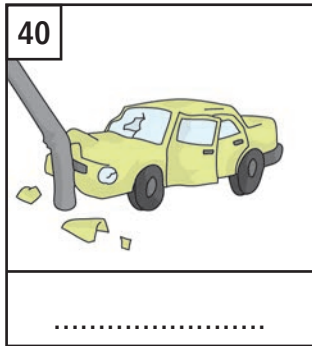
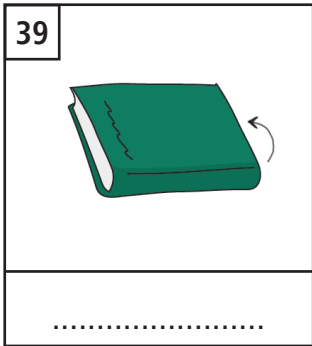
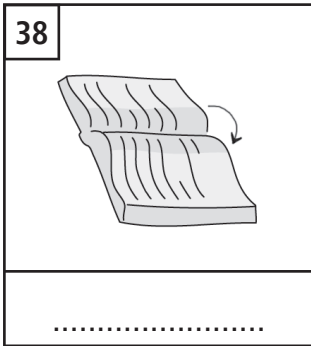
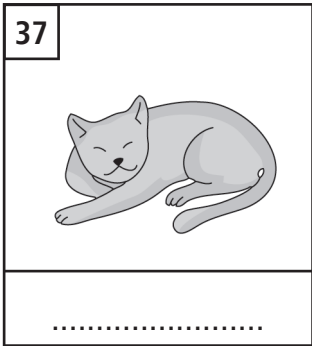
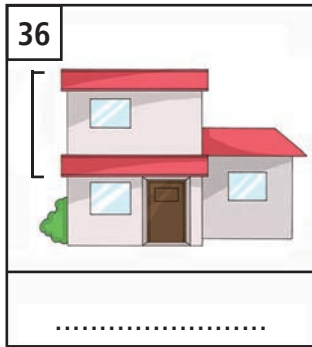
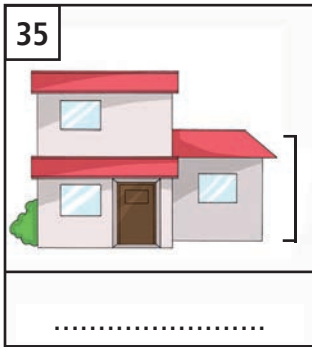
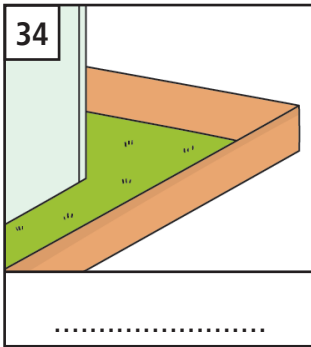
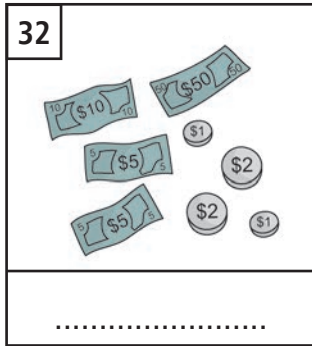
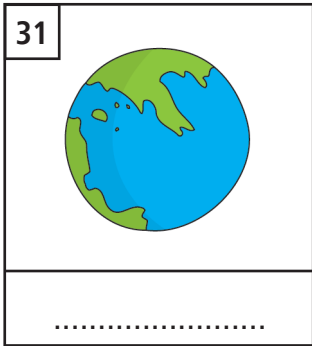
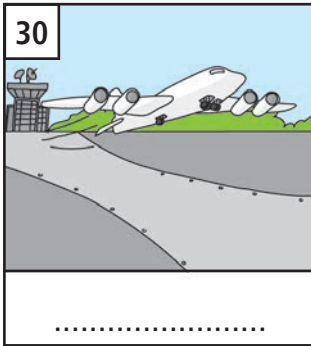
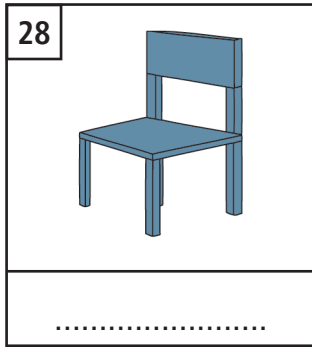
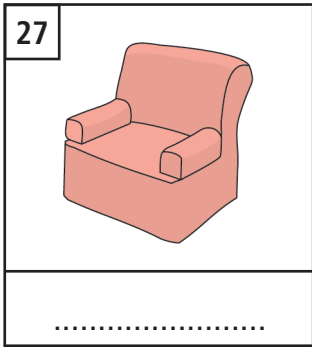
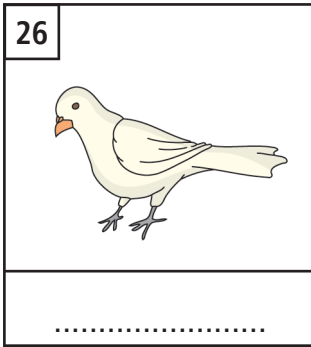
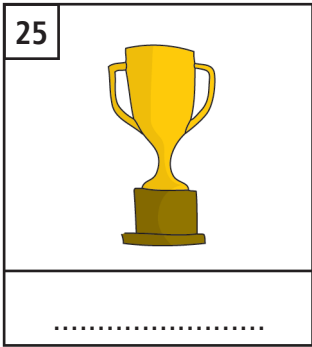
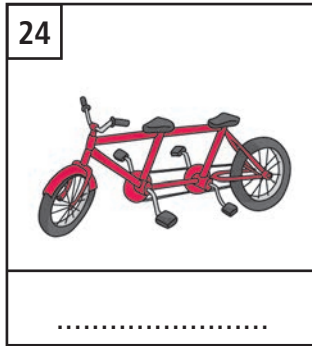
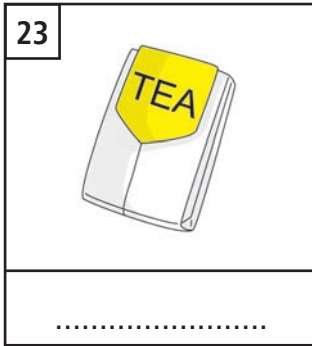
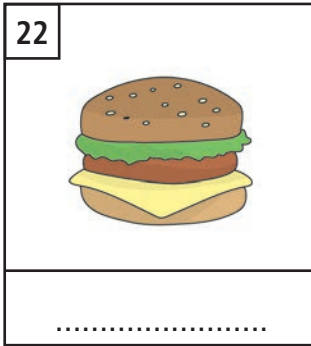
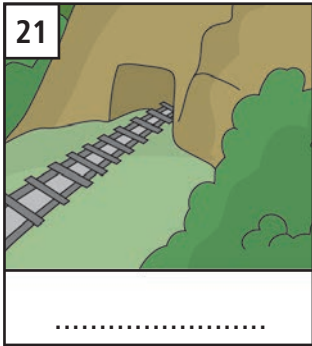

## UNIT 5

### A

- |                                      |                           |
|--------------------------------------|---------------------------|
| 1. How was the flight?               | a. It looks great.        |
| 2. Good to see you again.            | b. Thanks.                |
| 3. I'll meet you at the airport.     | c. It's been a long time. |
| 4. Have you been to the art gallery? | d. It was OK.             |
| 5. This is my new car.               | e. No, I haven't.         |

### B

- |   |                                   |
|---|-----------------------------------|
| 1. How have you been?                   | a. Very good.                     |
| 2. Where did you go last weekend?       | b. I stayed at home.              |
| 3. Where are they going tomorrow night? | c. Load the dishwasher.           |
| 4. What are you doing tomorrow?         | d. I'm working.                   |
| 5. How can I help?                      | e. They're going to a restaurant. |

### C

- |                                       |                       |
|---------------------------------------|-----------------------|
| 1. A parcel's arrived for you.        | a. Yesterday morning. |
| 2. I'm looking forward to the flight. | b. Good idea.         |
| 3. When did the fax arrive?           | c. Who's it from?     |
| 4. Can we go to the movie tonight?    | d. So am I.           |

### D

- |                                       |                            |
|---------------------------------------|----------------------------|
| 1. I want to go to a restaurant.      | a. No, and it's expensive. |
| 2. This is delicious.                 | b. The Grand Hotel.        |
| 3. What's the best hotel around here? | c. I'd rather see a movie. |
| 4. Is this restaurant good?           | d. Thank you.              |

message

idea

know

How

say

another

late

happened

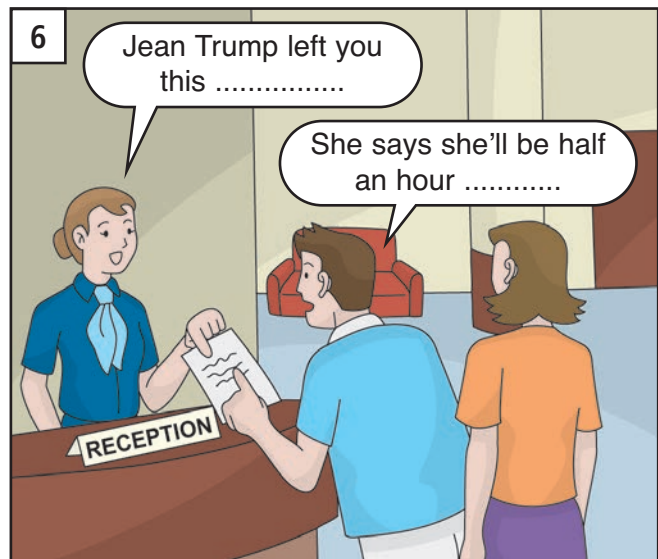
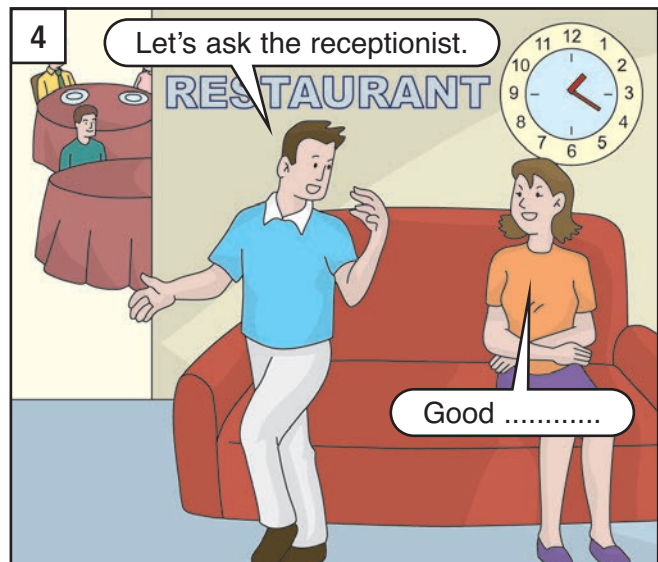
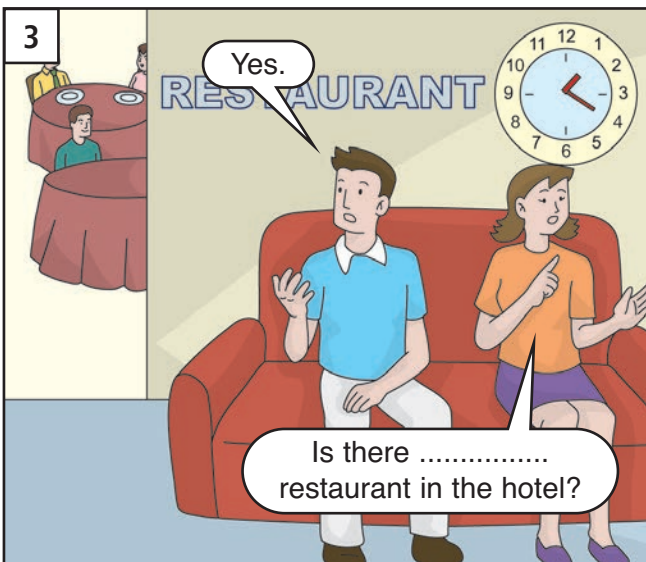
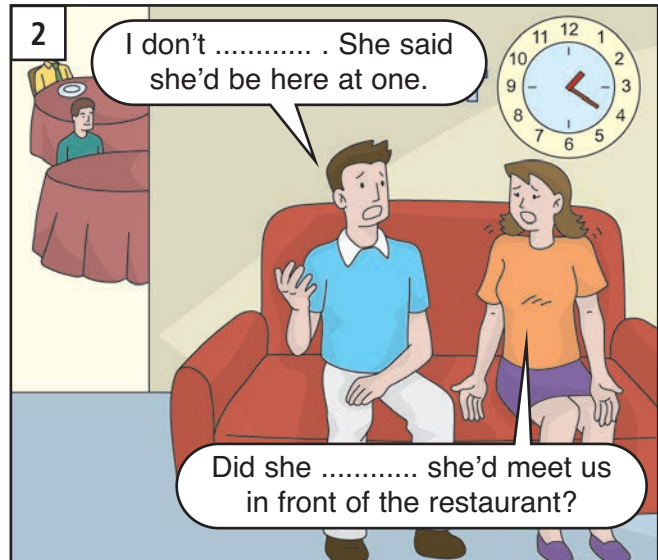
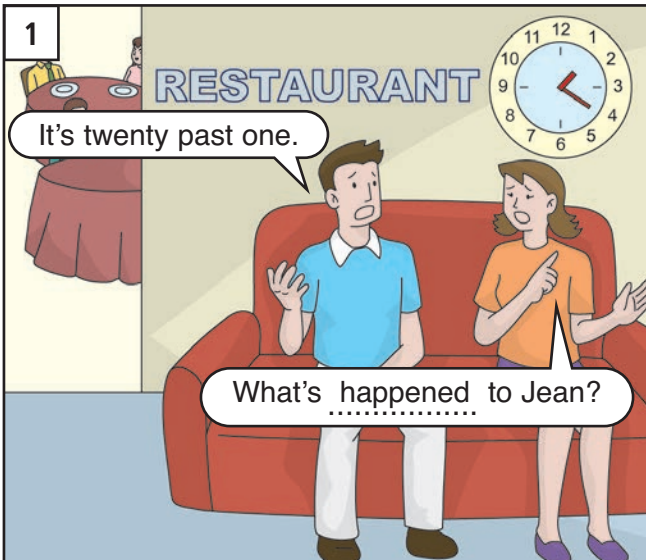

UNIT 5

What are about to sounds been another And time



time before around bit looking but at meet go

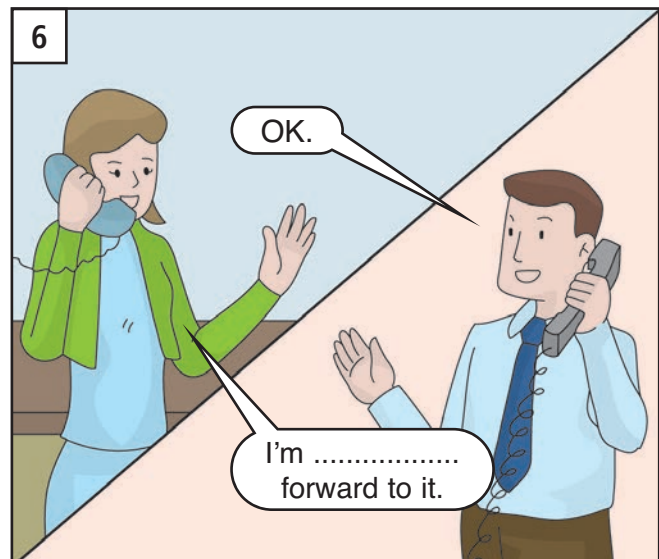
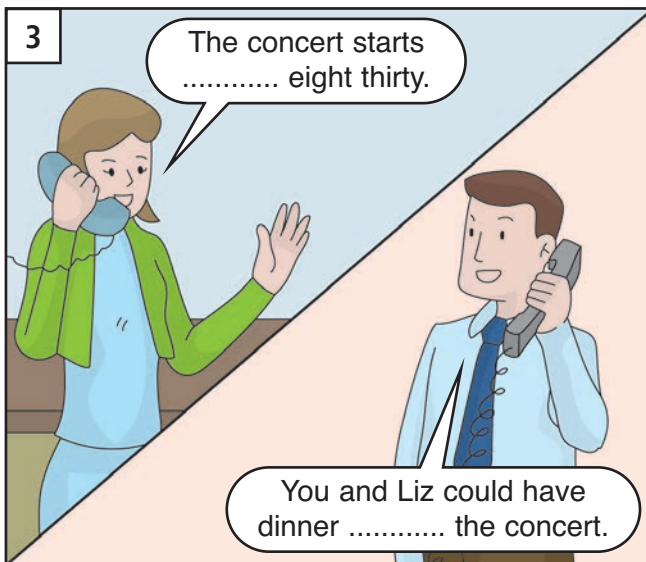
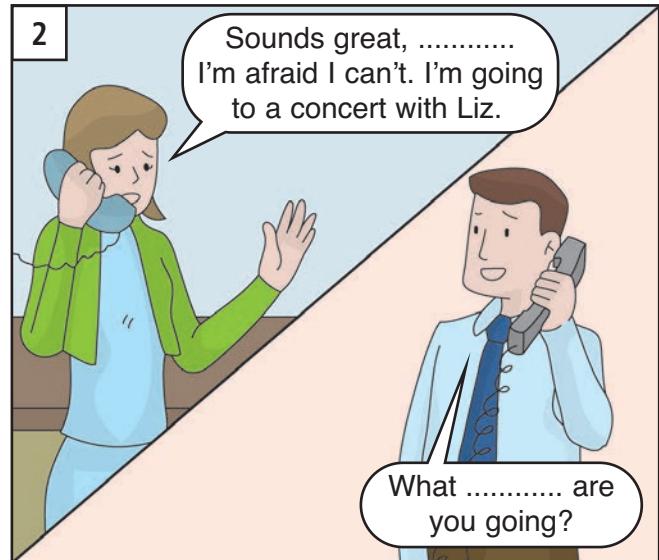
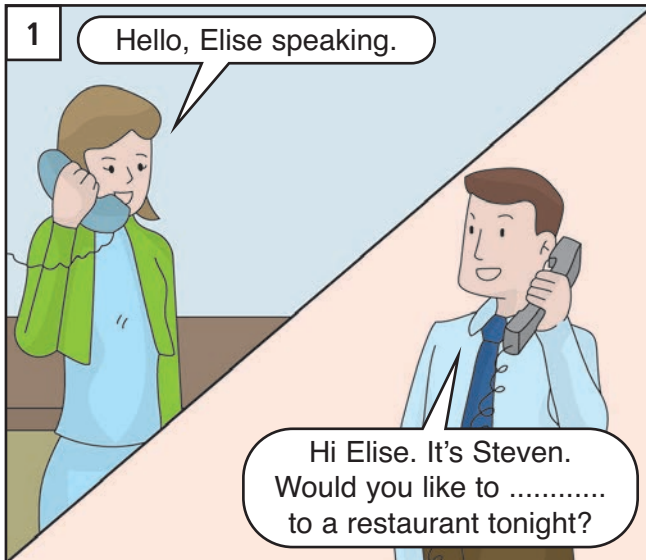

UNIT 5

them from sent wrong a won't says flight

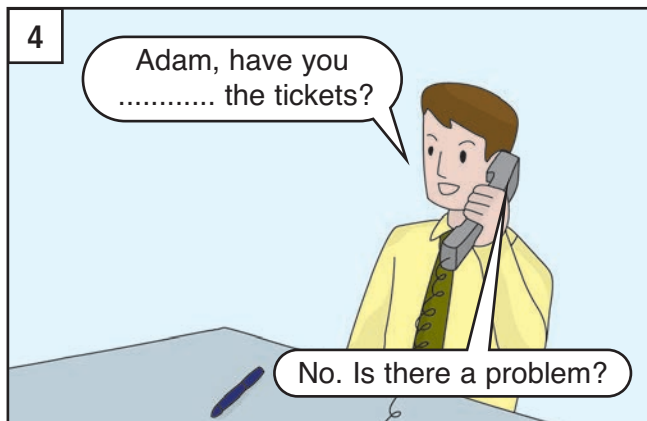
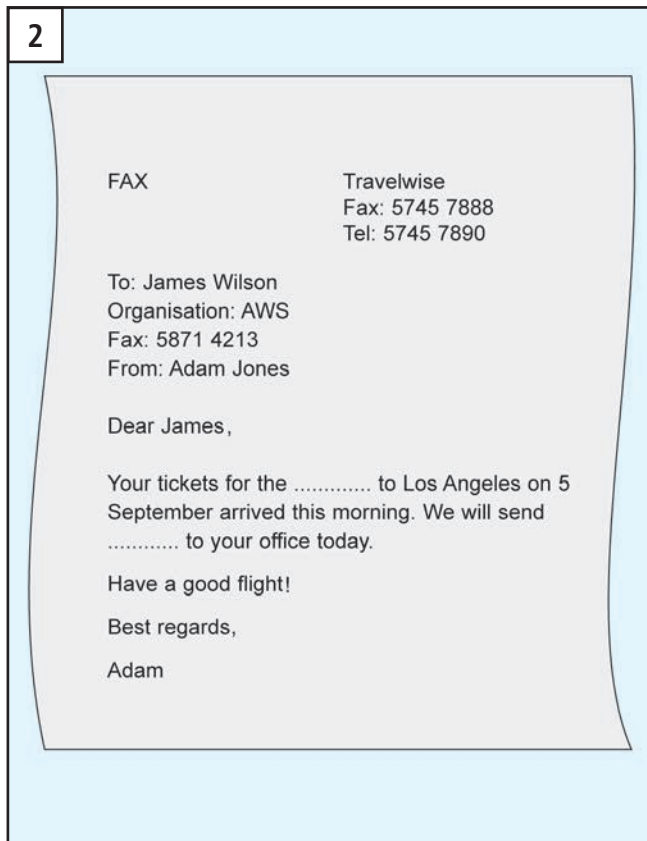

Revision and extension



- you How been have
- good Very

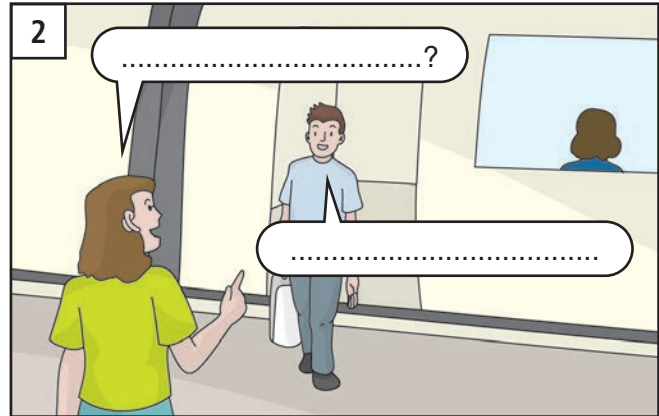

- trip was How the
- excellent was It

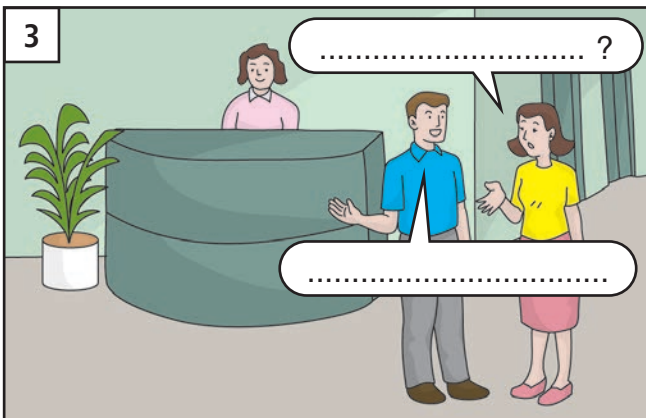

- the Where's restaurant
- receptionist ask Let's the



- here best What's around restaurant the
- know don't I



- been you Have shops to the
- I No haven't

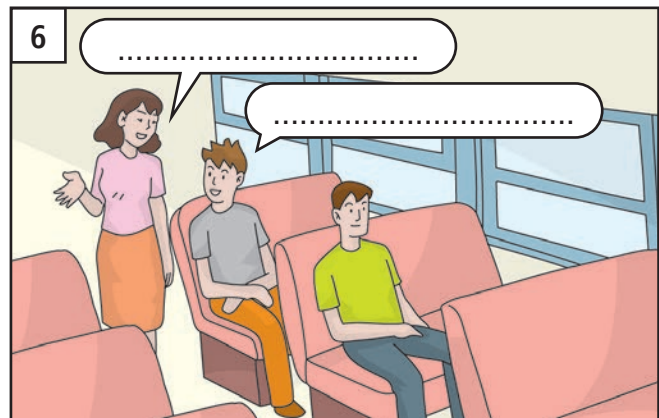

- to again It's good you see
- been It's long time a

UNIT 5

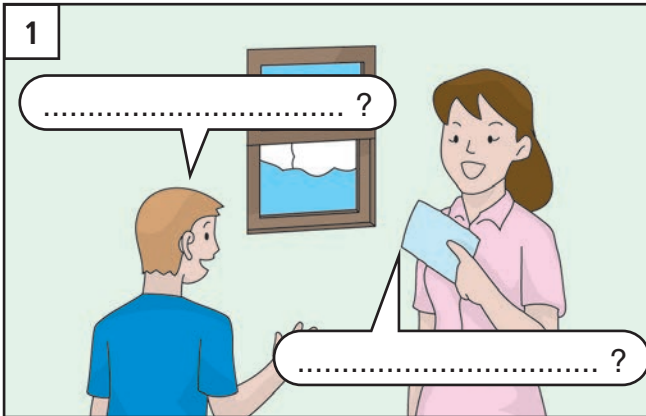

- I can How help
- this you post letter Could

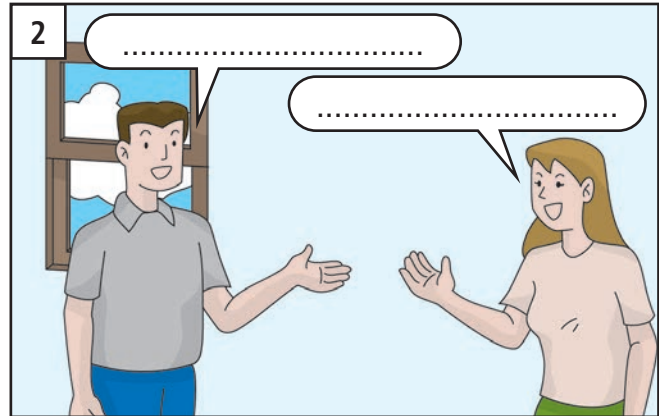

- want see to a movie I
- rather I'd go to the theater

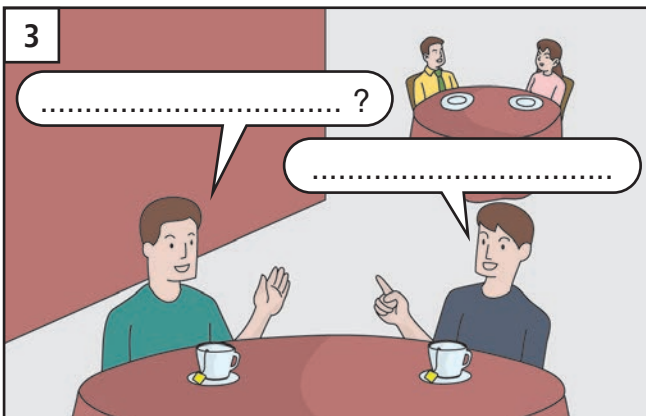

- go you did Where yesterday
- a movie went to We

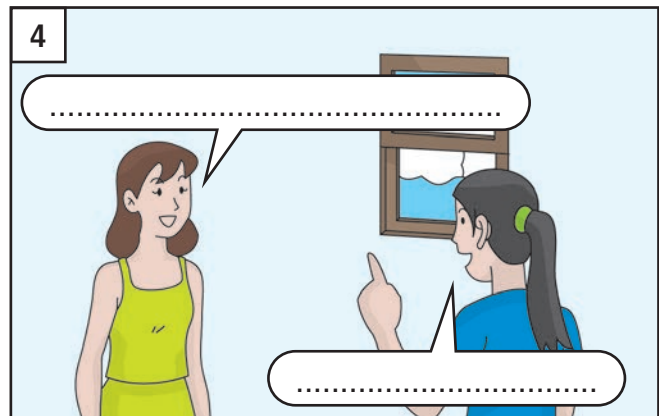

- go beach Saturday Let's to next the
- sounds That good

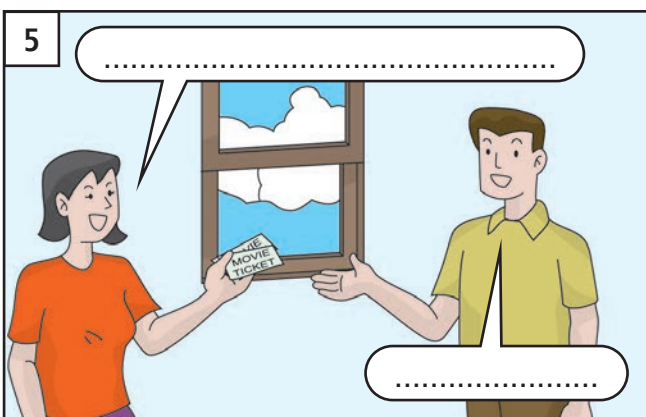

- looking movie to forward the I'm
- am So I



- tomorrow you doing What are
- the art to going I'm gallery

## Answers to Unit 5

### Unit 5, page 44

- |                |            |                |              |                 |
|----------------|------------|----------------|--------------|-----------------|
| 1. letter      | 2. stamp   | 3. parcel      | 4. letterbox | 5. postcard     |
| 6. postman     | 7. fax     | 8. path        | 9. roof      | 10. back seat   |
| 11. front seat | 12. garage | 13. fence      | 14. gate     | 15. balcony     |
| 16. shed       | 17. toilet | 18. double bed | 19. bath     | 20. dining room |

### Unit 5, page 45

- |                |               |           |              |              |
|----------------|---------------|-----------|--------------|--------------|
| 21. tunnel     | 22. hamburger | 23. tea   | 24. tandem   | 25. trophy   |
| 26. bird       | 27. sofa      | 28. chair | 29. land     | 30. take off |
| 31. world      | 32. money     | 33. stars | 34. backyard | 35. upstairs |
| 36. downstairs | 37. cat       | 38. open  | 39. closed   | 40. accident |

### Unit 5, page 46

- A. 1d 2c 3b 4e 5a      B. 1a 2b 3e 4d 5c      C. 1c 2d 3a 4b      D. 1c 2d 3b 4a

### Unit 5, page 47

1. happened      2. know, say      3. another      4. idea      5. How      6. message, late

### Unit 5, page 48

1. been, to      2. time      3. are, another      4. And      5. What      6. about, sounds

### Unit 5, page 49

1. go      2. but, time      3. at, before      4. around, bit      5. meet      6. looking

### Unit 5, page 50

1. from      2. flight, them      3. says, wrong      4. sent      5. won't      6. a

### Unit 5, page 51

- How have you been?  
Very good.
- How was the trip?  
It was excellent.
- Where's the restaurant?  
Let's ask the receptionist.
- What's the best restaurant around here?  
I don't know.
- Have you been to the shops?  
No I haven't.
- It's good to see you again.  
It's been a long time.

### Unit 5, page 52

- How can I help?  
Could you post this letter?
- I want to see a movie.  
I'd rather go to the theater.
- Where did you go yesterday?  
We went to a movie.
- Let's go to the beach next Saturday.  
That sounds good.
- I'm looking forward to the movie.  
So am I.
- What are you doing tomorrow?  
I'm going to the art gallery.

# UNIT 6: You always watch movies!

switch  
turn on  
turn off

radio  
kettle  
light  
computer  
printer

loud  
soft  
turn up  
turn down  
remote control  
channel  
fish

I'd rather  
instead

fine            sunny  
cloudy        showers  
wet            rain  
windy        snow  
storm        foggy

thermometer  
temperature  
hot            cold

weather report  
weather forecast

plane crash  
news  
advertisement  
sport  
comedy

alone  
together  
visit

do the dishes

hope  
disappointed

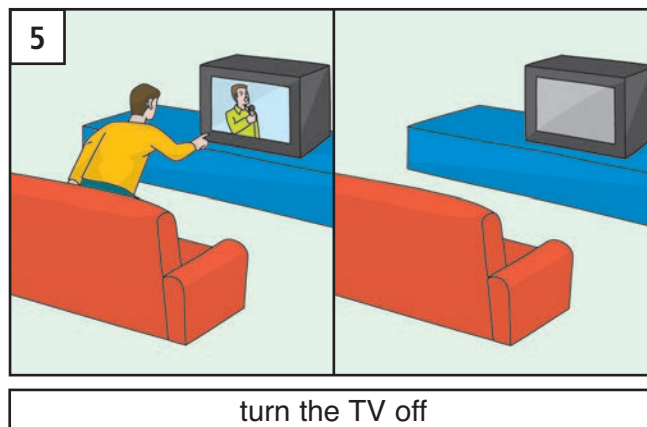
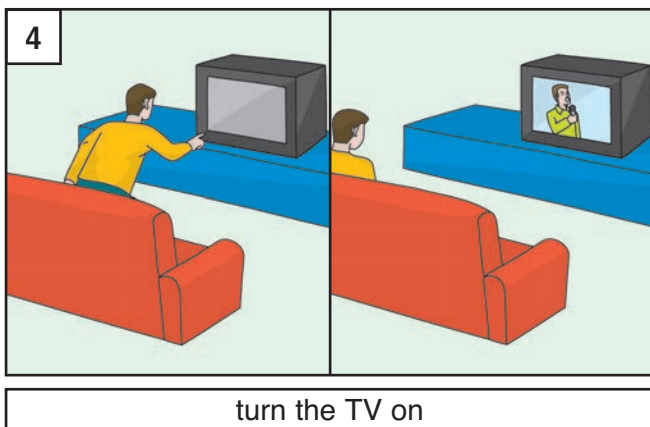
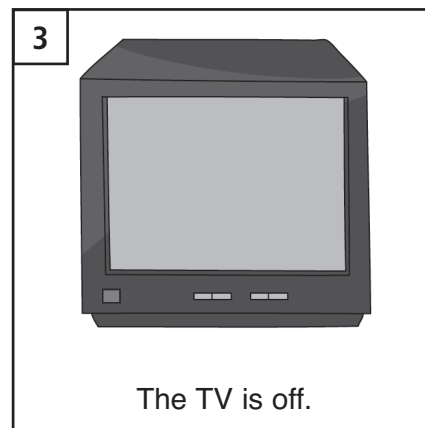
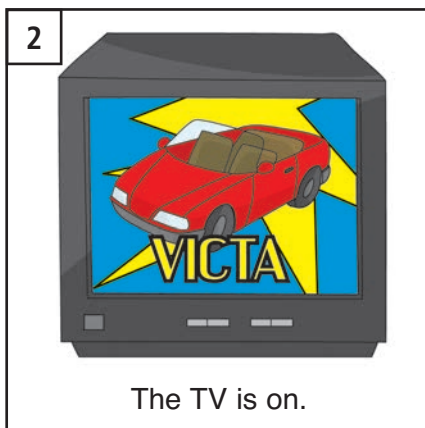
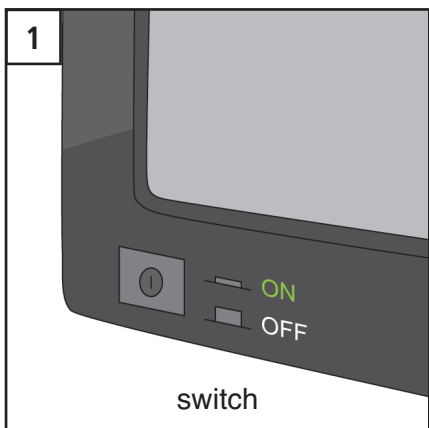

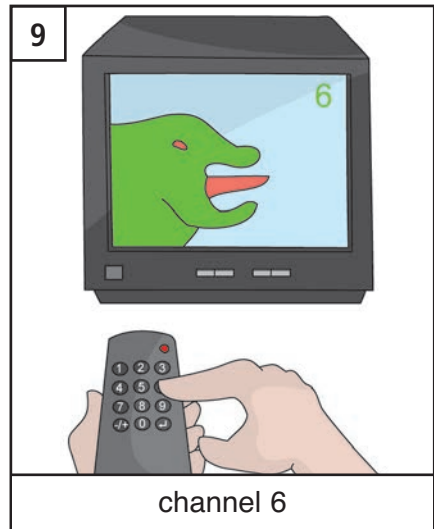
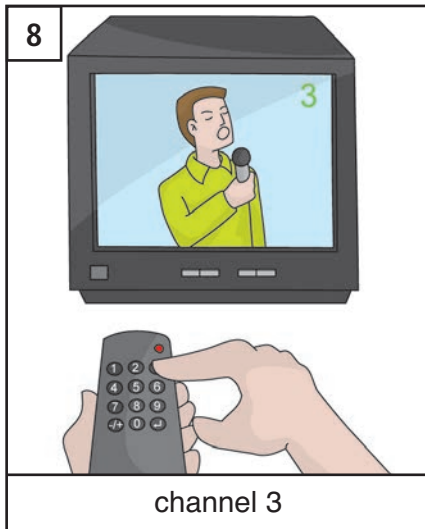
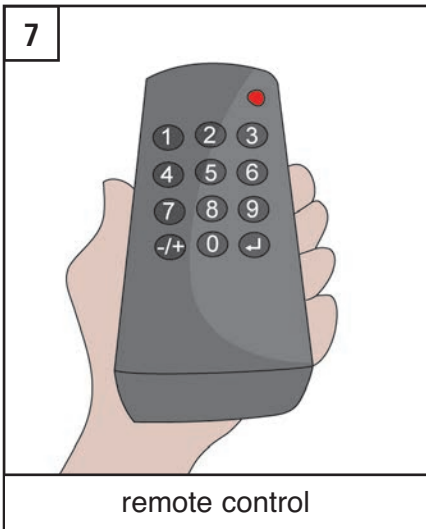
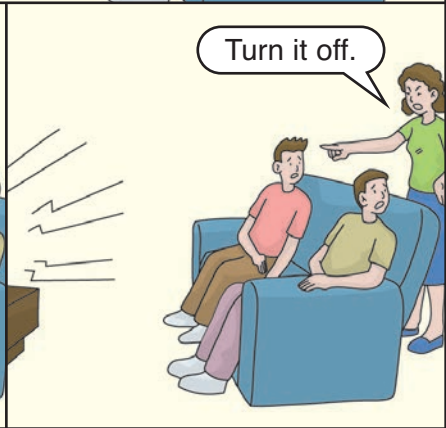
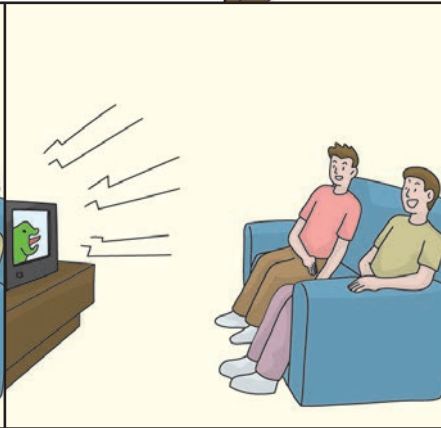
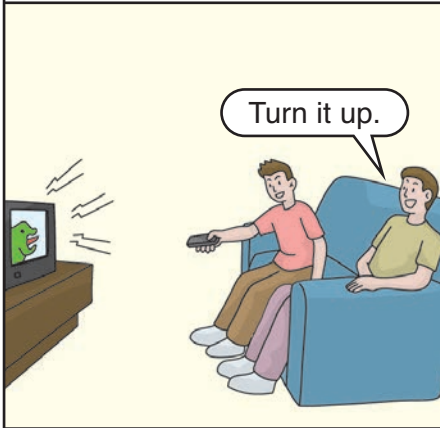
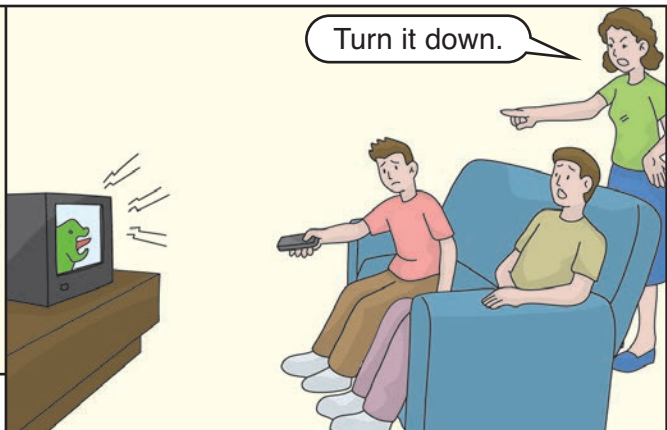
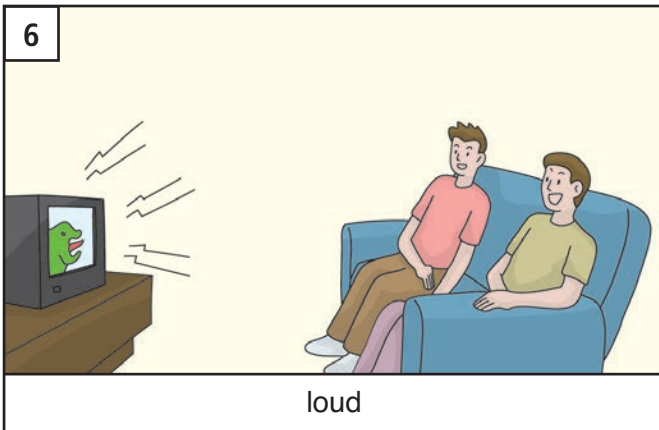
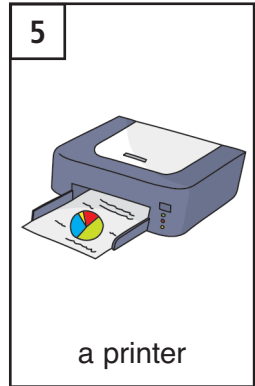
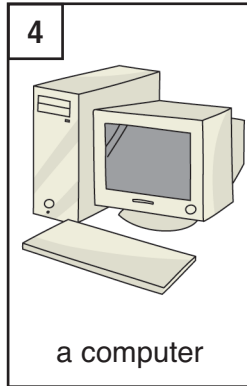
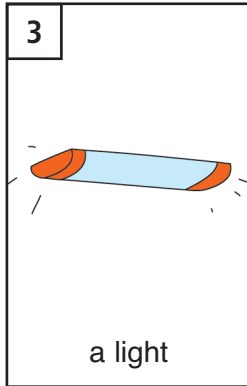
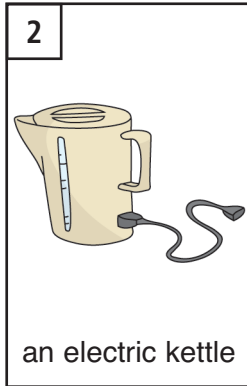
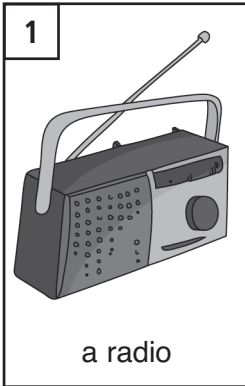

UNIT 6

weather

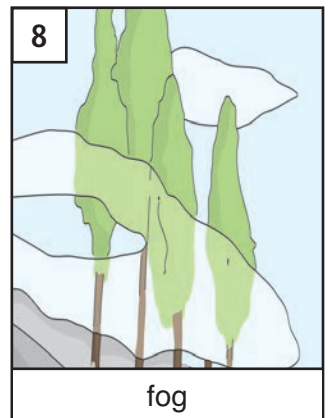
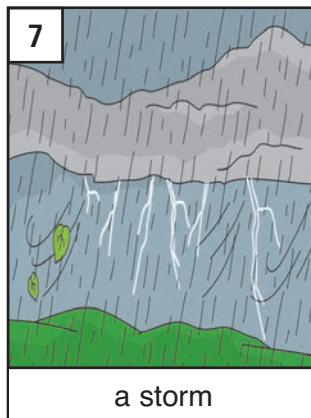
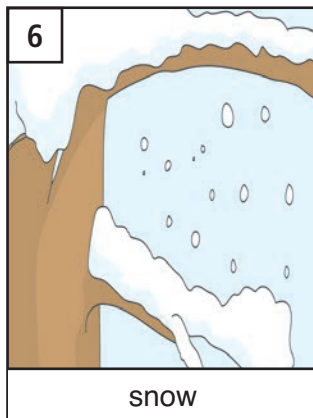
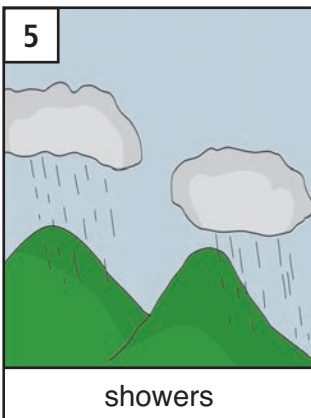
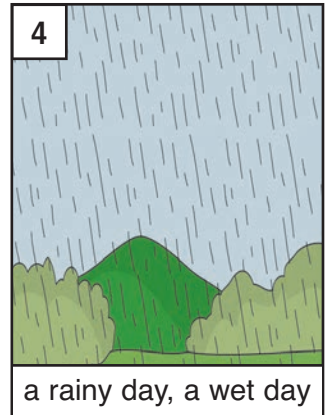
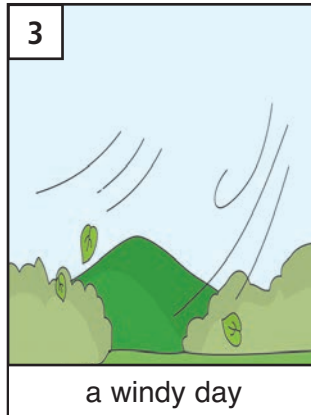
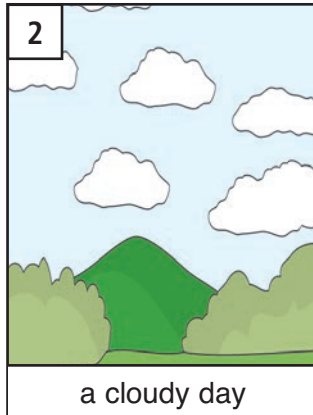
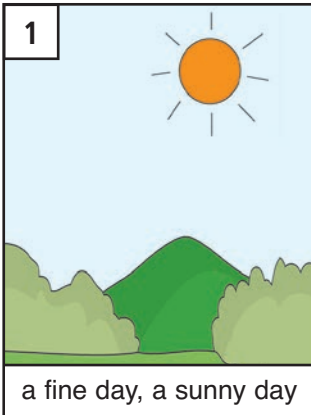

temperature

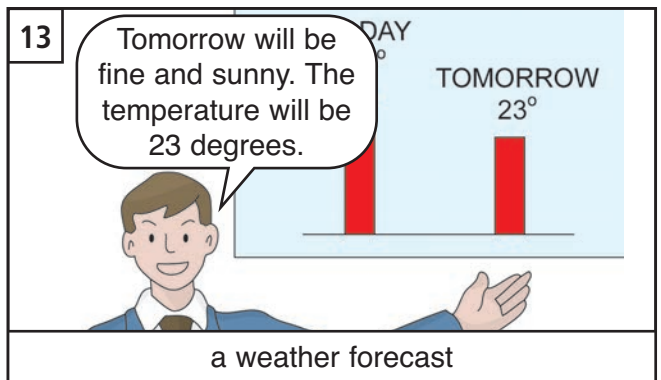
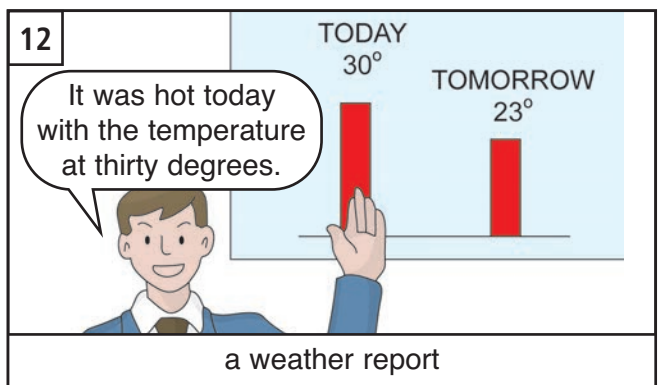
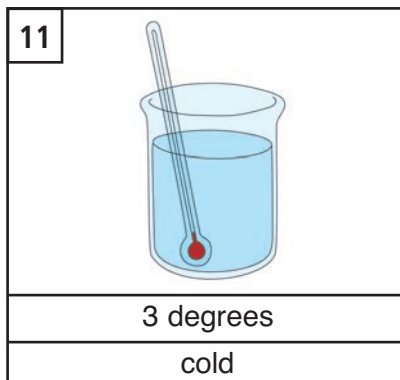
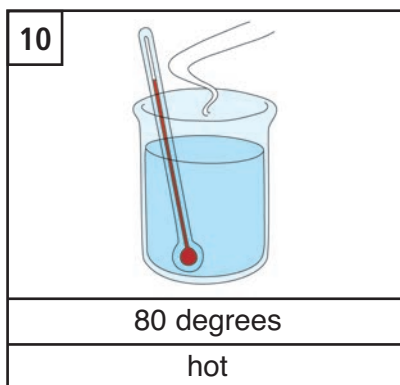
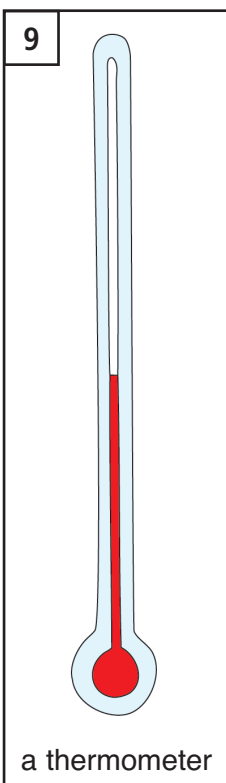

1

This morning there was a plane crash.



news

2

Victa is the best car.



an advertisement for Victa cars

3

I love you Roxanne but ...



movie

4



sport



sport

5

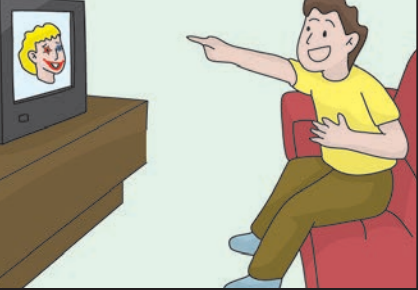

a comedy

6

I'd like to watch the sport on channel 7.

I'd rather watch the movie on channel 8.

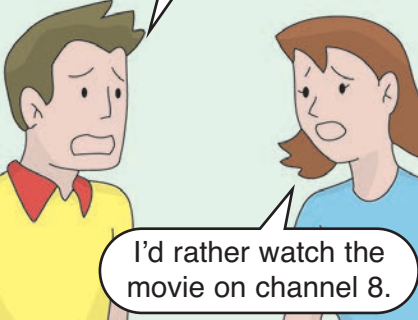

But you always watch movies. I never watch sport!

No, you always watch sport and I never watch movies!

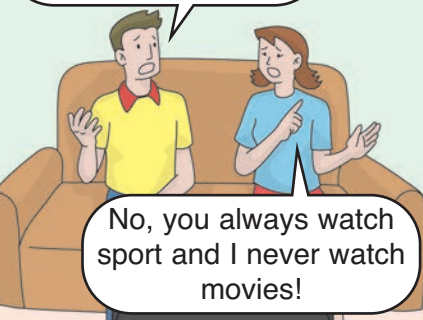

7

It's too wet to go to the park. We'll watch this DVD instead.



Sport is more interesting. Movies are boring.

No, movies are more interesting than sport. Sport is very boring.

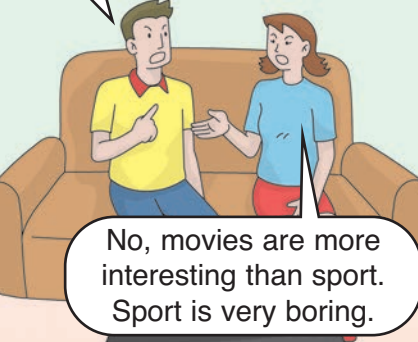

Let's go to the park instead of watching TV.

OK.



UNIT 6

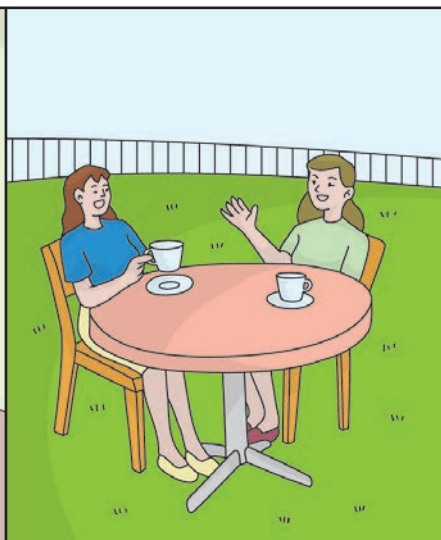

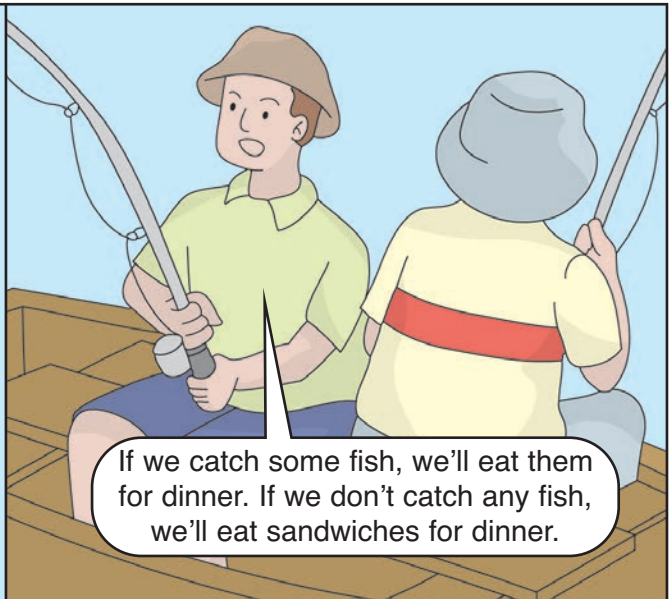
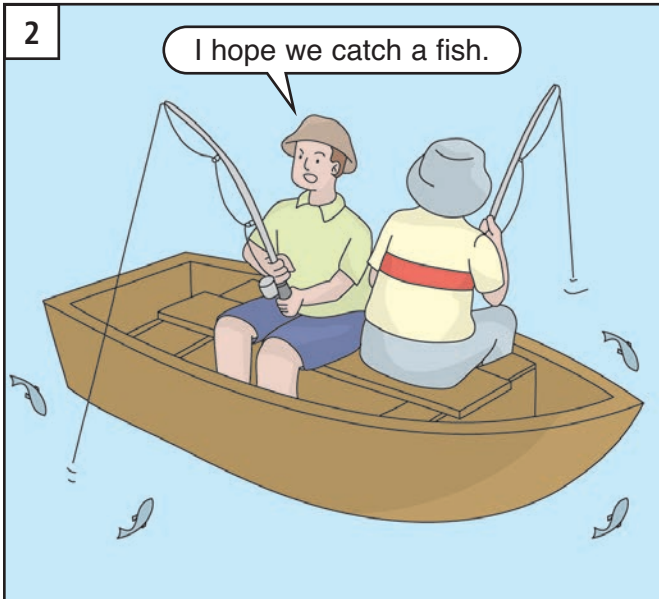
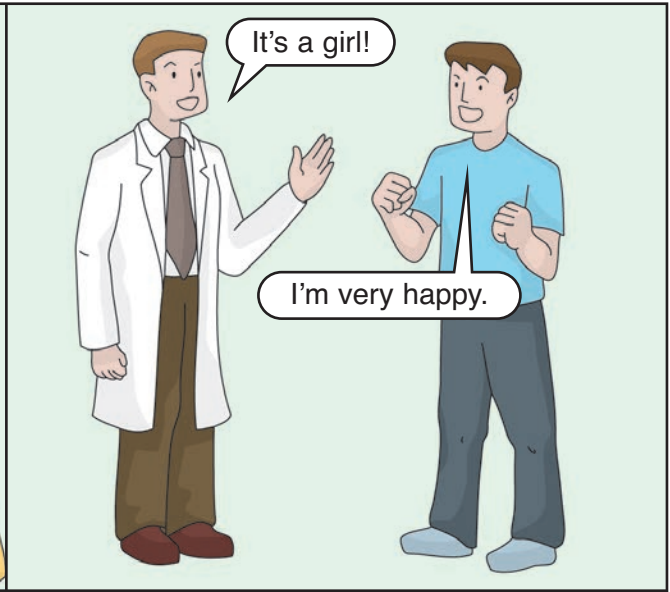
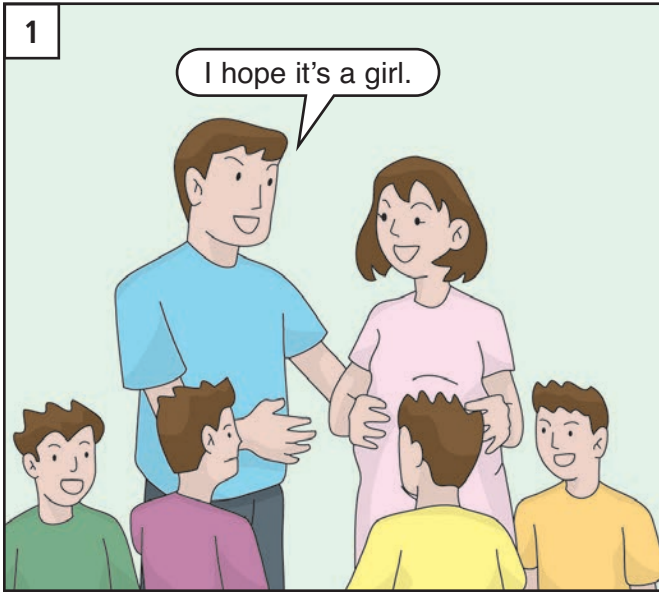

# The Bensons

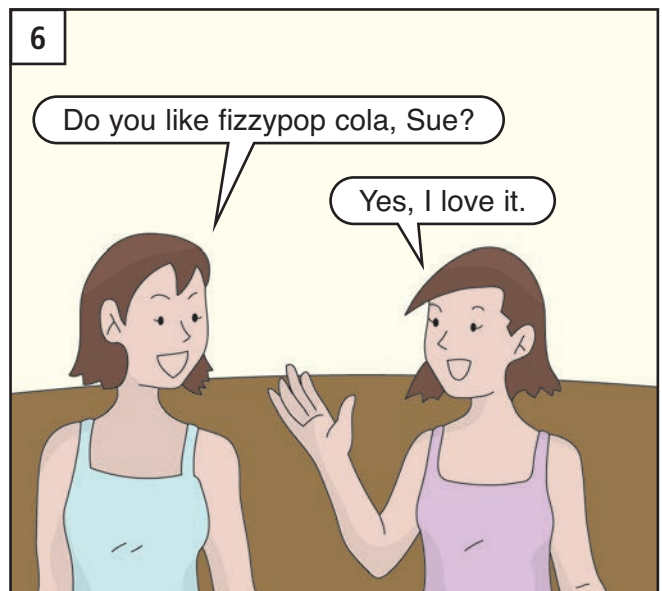
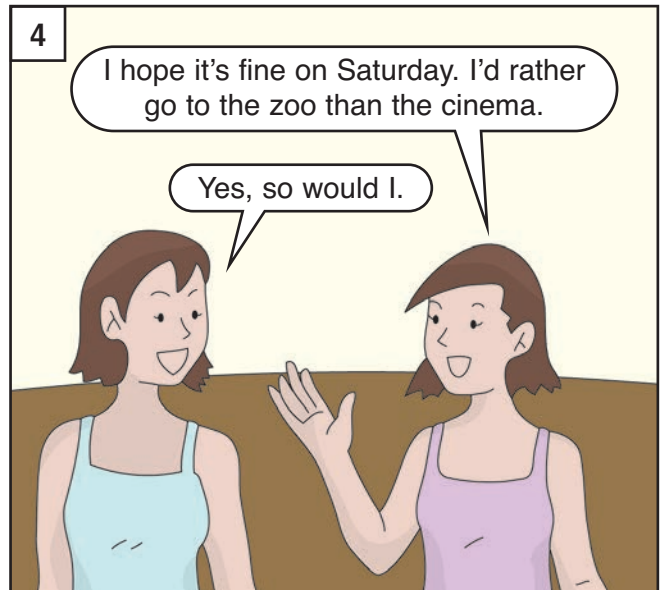
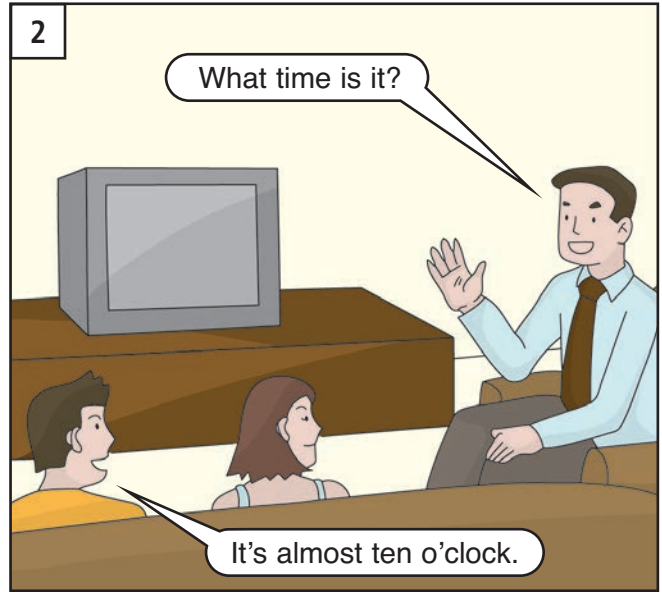
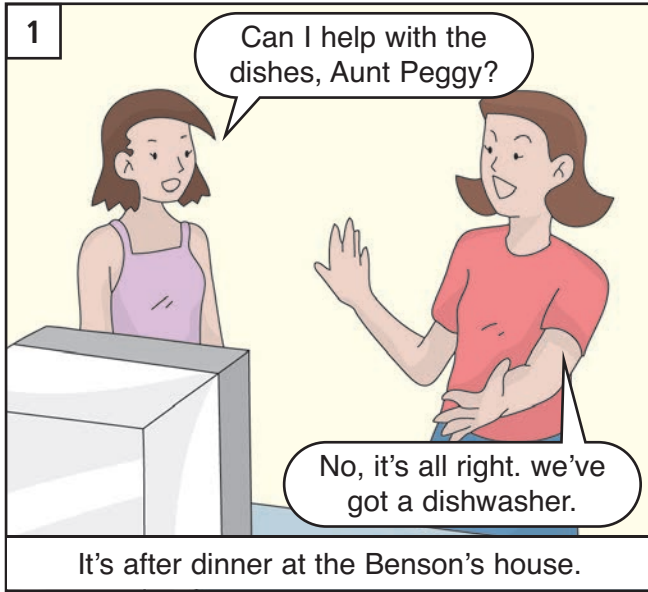

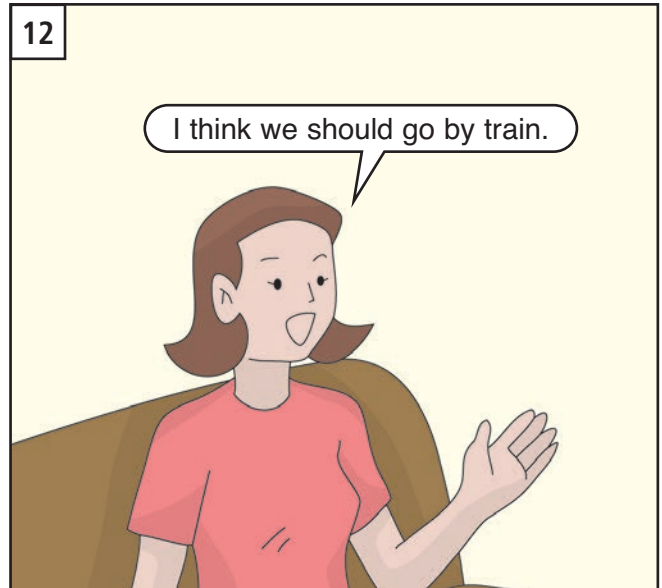
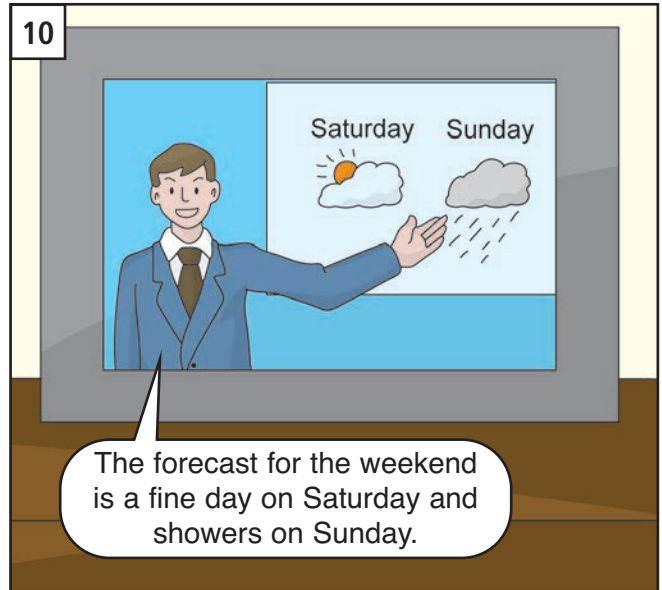
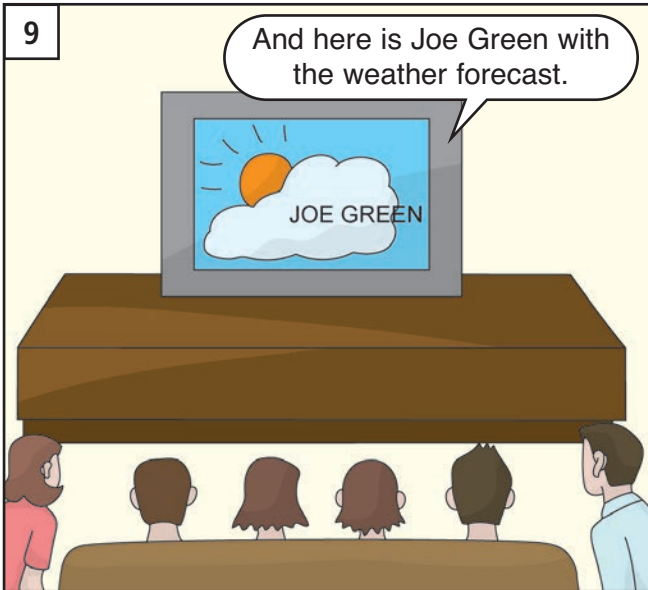
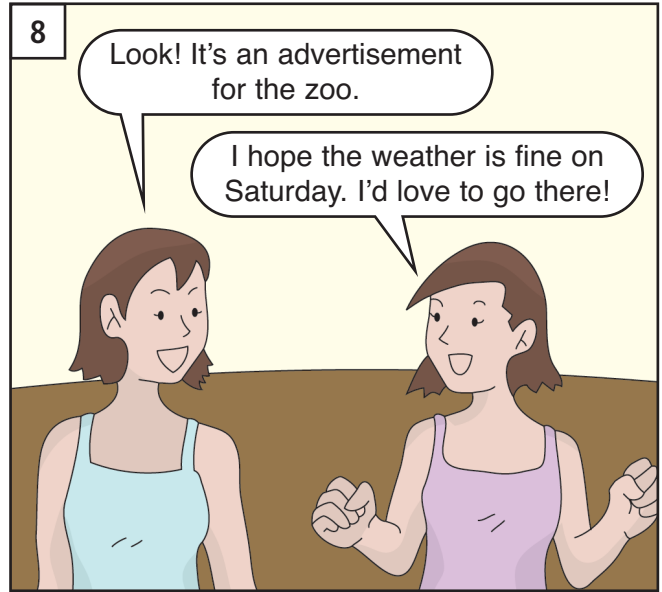
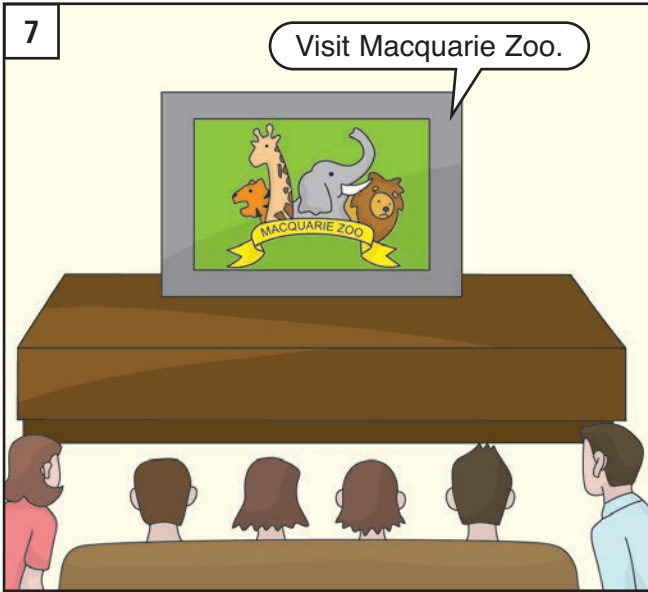

## UNIT 7: I'd like to see a doctor.

comb  
lipstick  
mascara  
eyelash  
face  
powder  
hair

busy

ready

go away  
come back  
return  
single

express  
via

twin  
umbrella

which

because  
so

pick up

ticket office  
platform  
kiosk  
newsagent  
waiting room  
luggage  
attendant  
timetable  
entry  
exit  
toilets  
lost property

forget  
remember

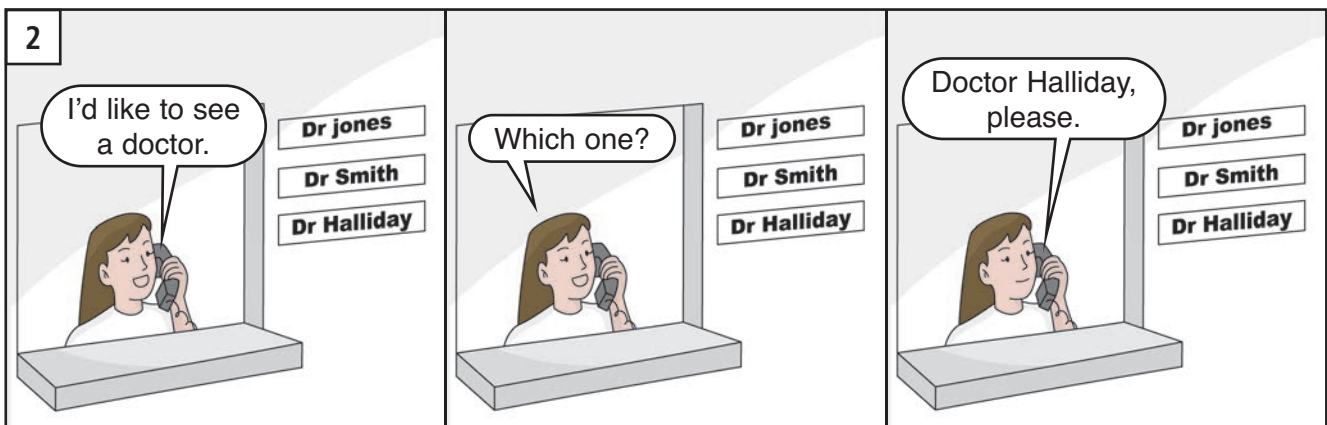

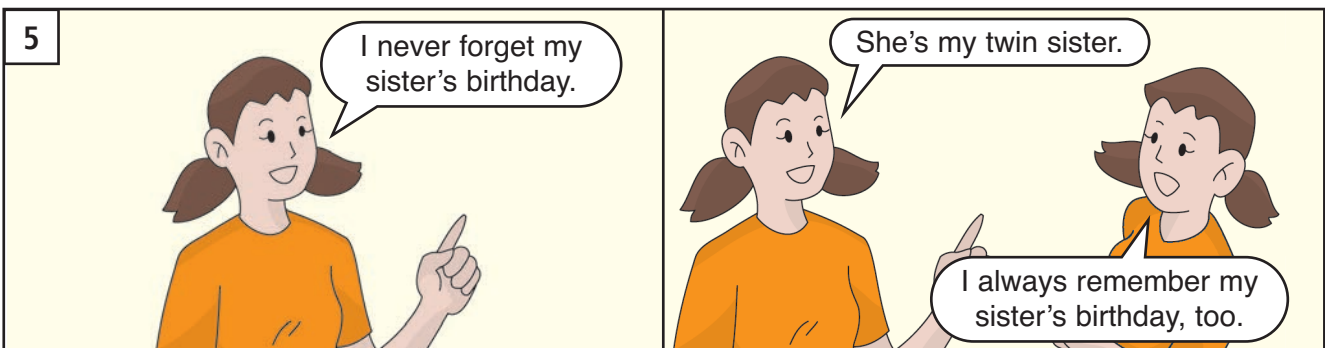
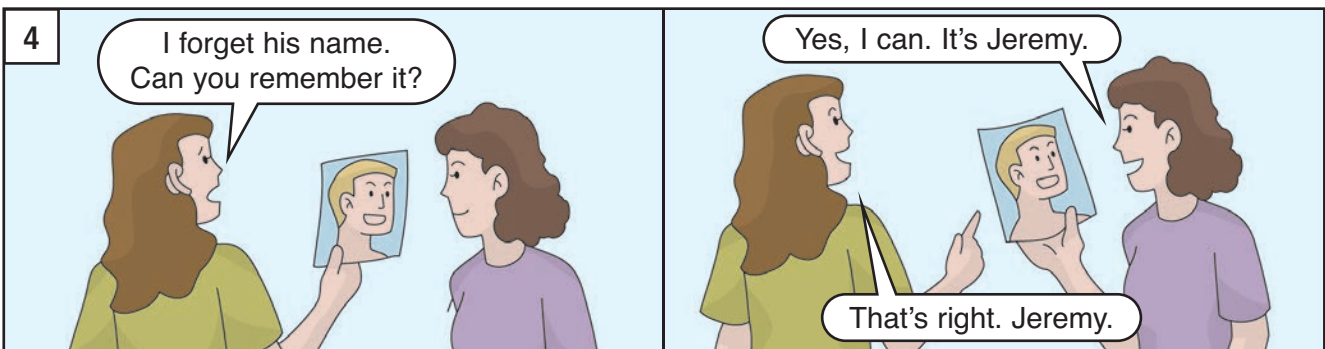
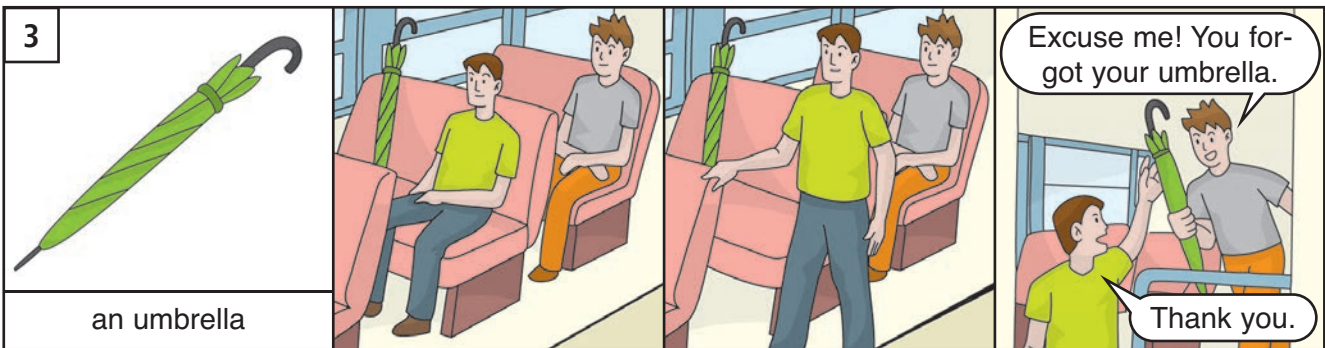
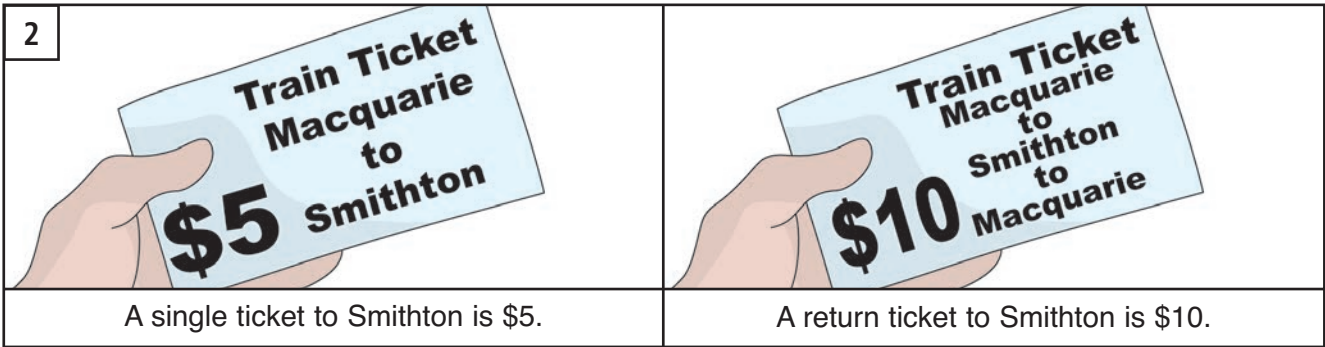
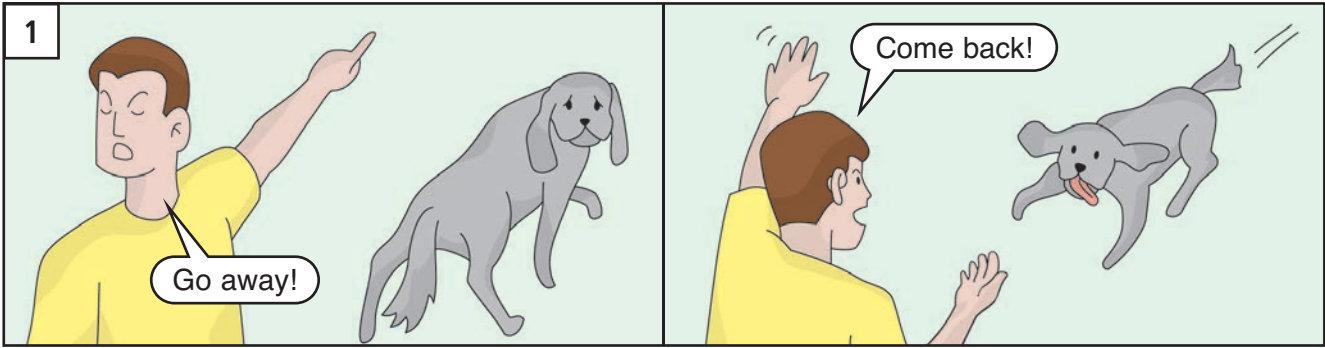

UNIT 7

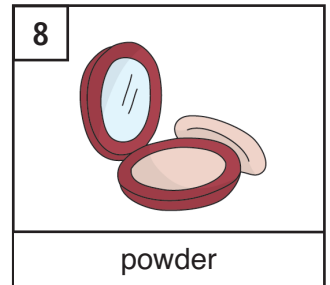
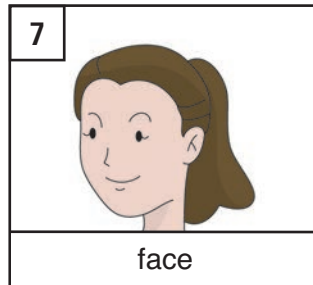
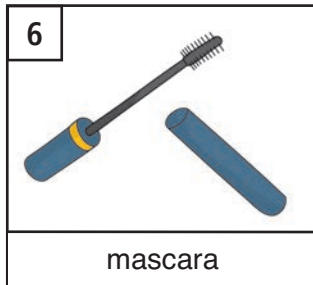
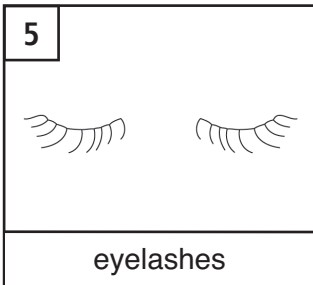
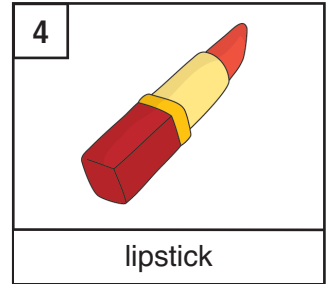
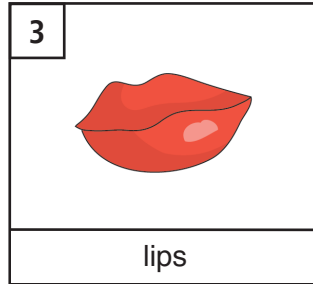
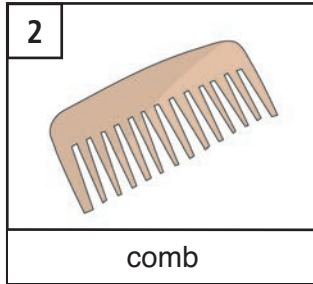
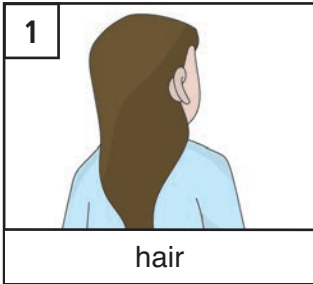

I'd like to see a doctor.



UNIT 7

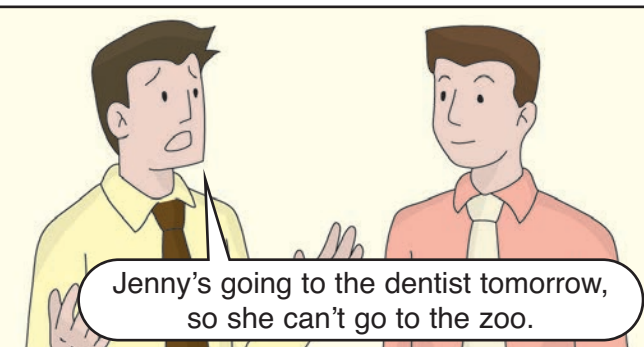
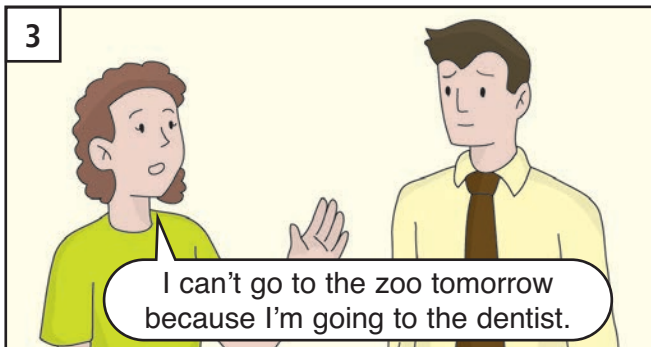
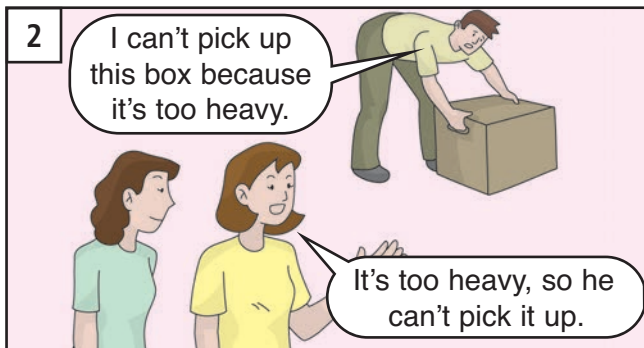

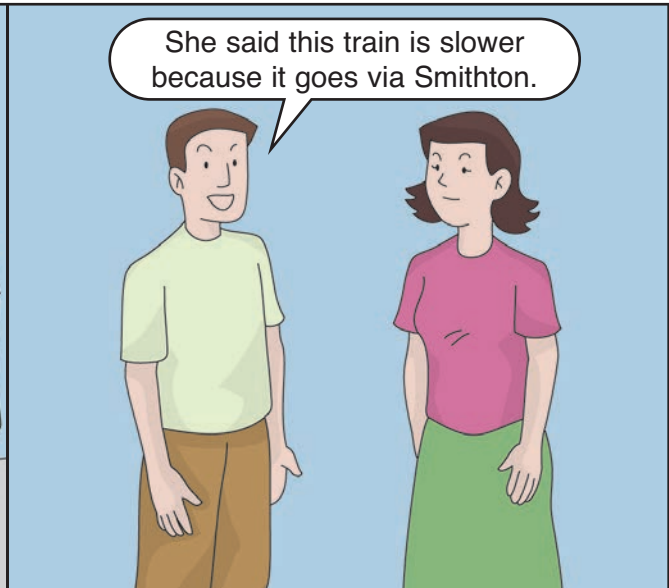
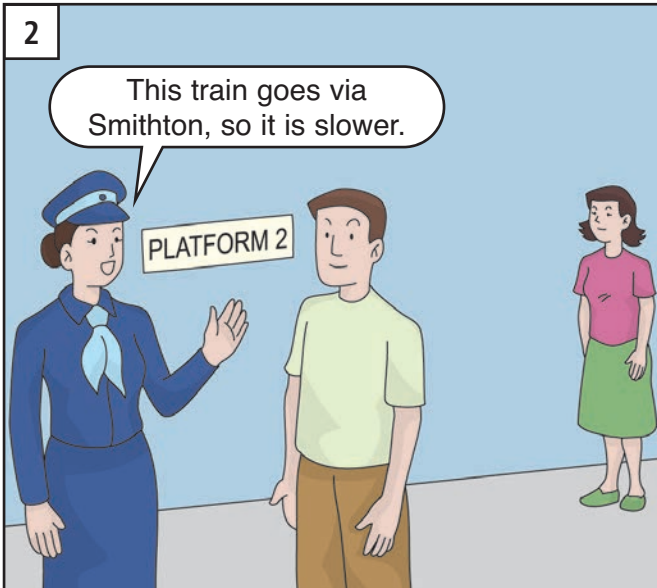
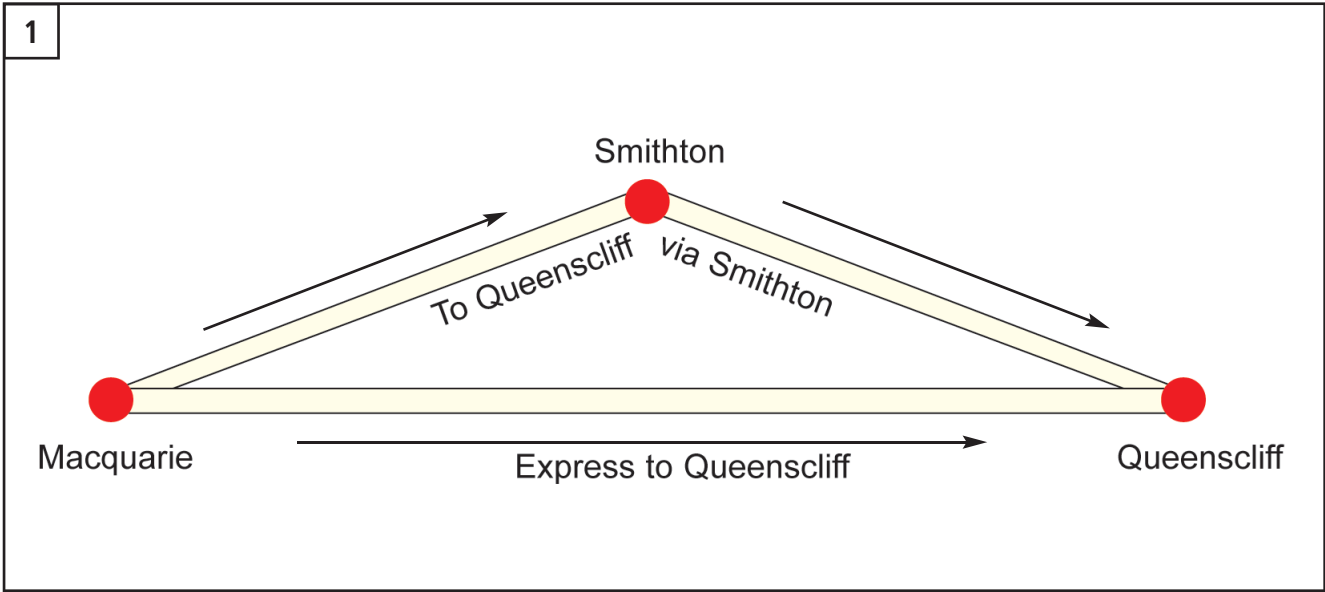

# The Bensons

1

Have you got your umbrella, Anne?

I don't need it. It's not going to rain.

It's Saturday and the Benson family is getting ready to go to the zoo.

2

Have you got your camera, Tom?

Yes, I've got it, Mom.

3

Are you ready to go, Sue?

Yes, I'm ready, Dad.

4

We have to go now. The train leaves in ten minutes.

5

The Bensons are going to the station.

6

Six to the zoo, please.

Return?

Yes, six returns to the zoo, please.

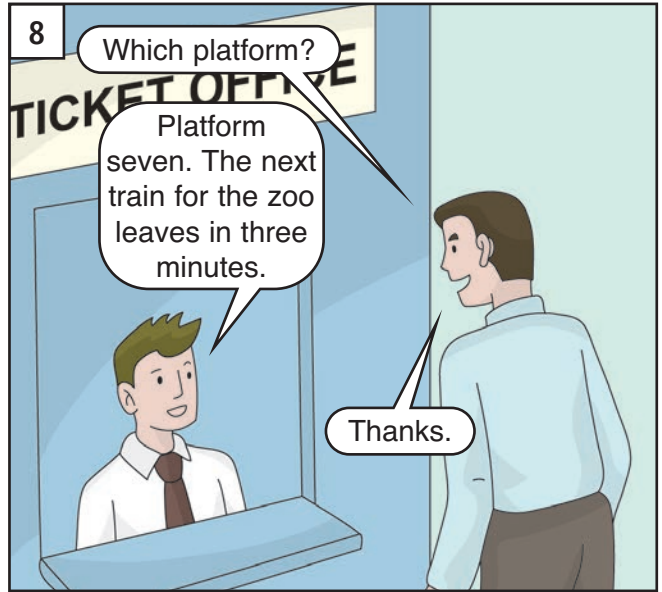
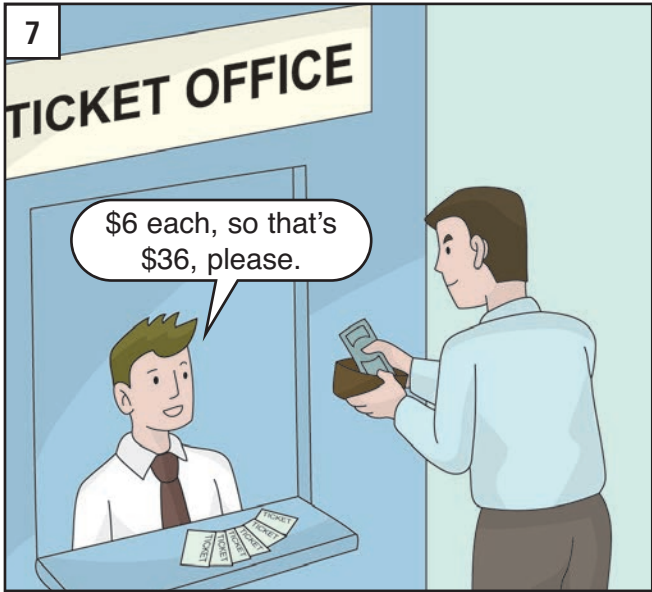

## UNIT 8: Ten dollars extra.

who  
where  
when  
how  
why  
what

separate  
join

ice  
lion  
tiger  
giraffe  
antelope  
koala  
kangaroo  
seal  
elephant  
zebra  
fur  
pouch

start  
finish  
take

tree  
trunk  
branch  
leaf

tour

hill

top  
bottom

extra

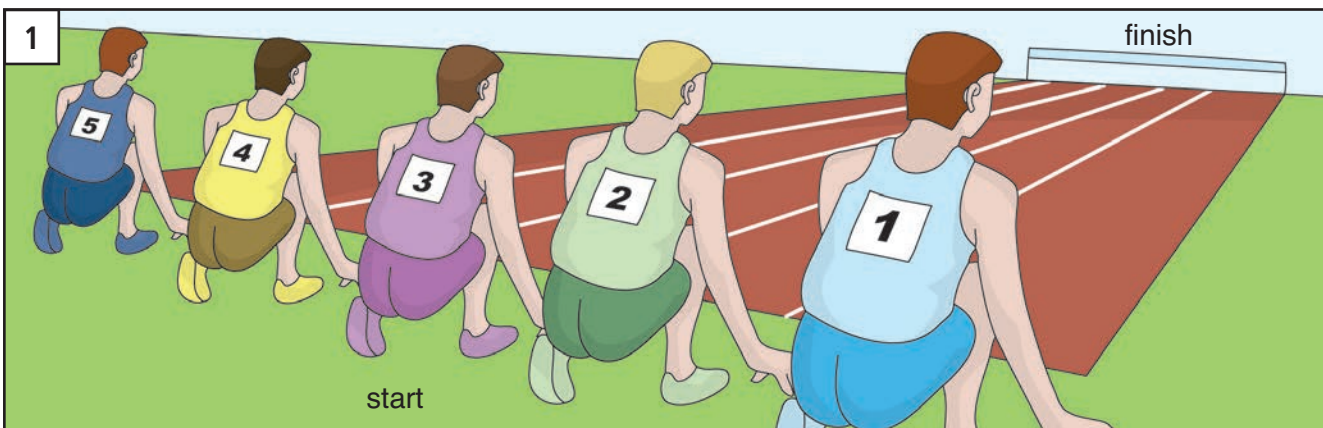

**2**

Meeting:  
1 p.m. - 2 p.m.

The meeting starts at one o'clock and finishes at two o'clock.

The meeting takes an hour.

**3**

DEPART TOKYO 11 A.M.  
ARRIVE SYDNEY 7 P.M.

The flight \_\_\_\_\_ at eleven o'clock and \_\_\_\_\_ at seven o'clock.

DEPART TOKYO 11 A.M.  
ARRIVE SYDNEY 7 P.M.

The flight takes eight hours.

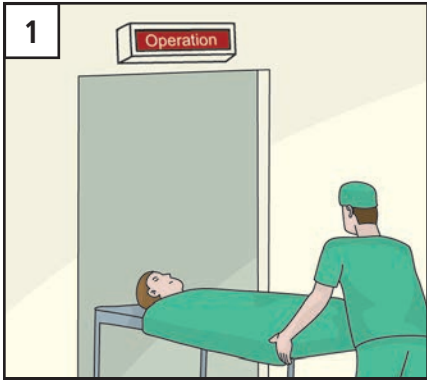

1

Monday 7 a.m.

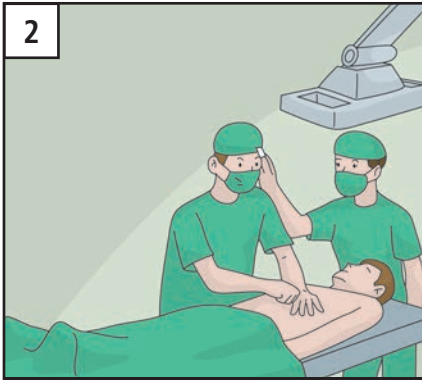

2

an operation

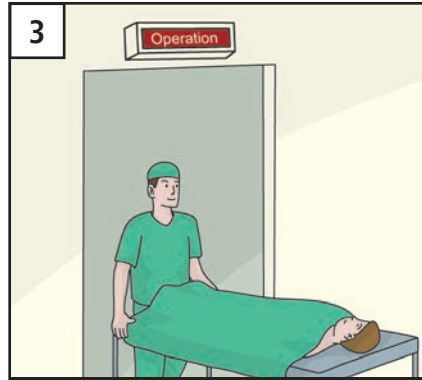

3

Monday 2 p.m.

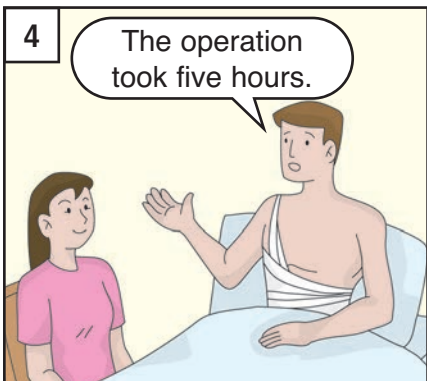

4

The operation took five hours.

Wednesday



5

When will you finish?

I don't know. It'll take a long time.

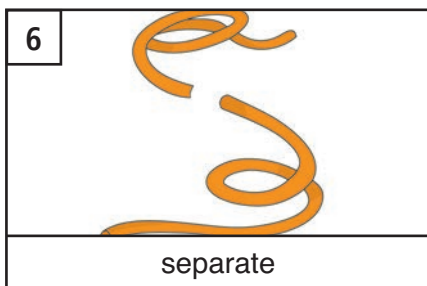

6

separate

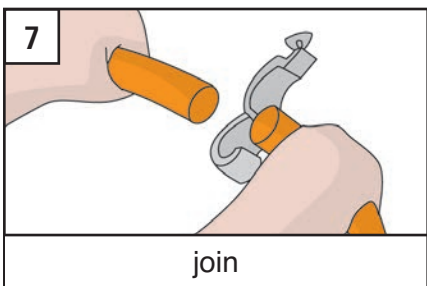

7

join

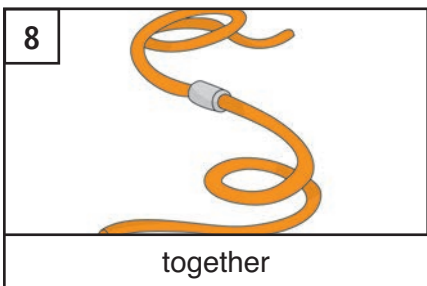

8

together

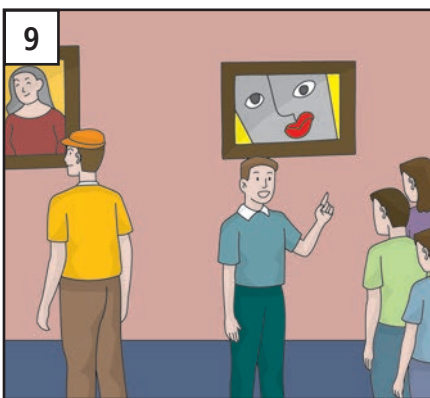

9

Harry went to the art gallery.



He joined a tour group.



Where have you been, Harry?

I went to the art gallery.



Did you like it?

Yes, I joined a tour. It was very interesting.

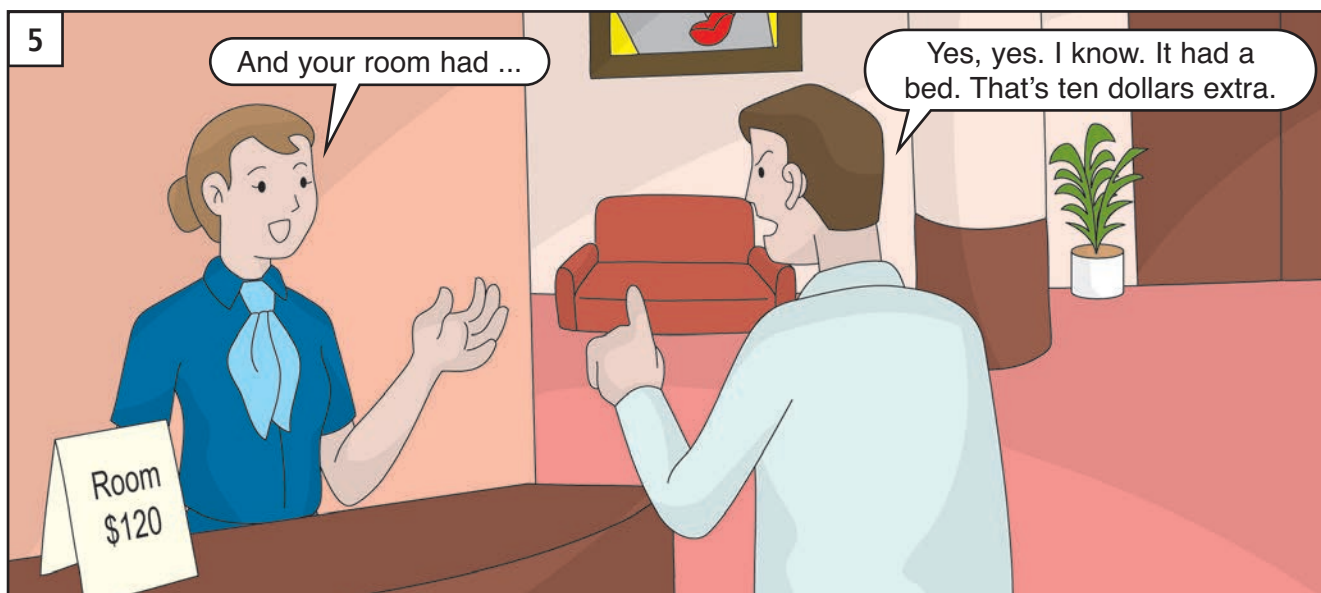
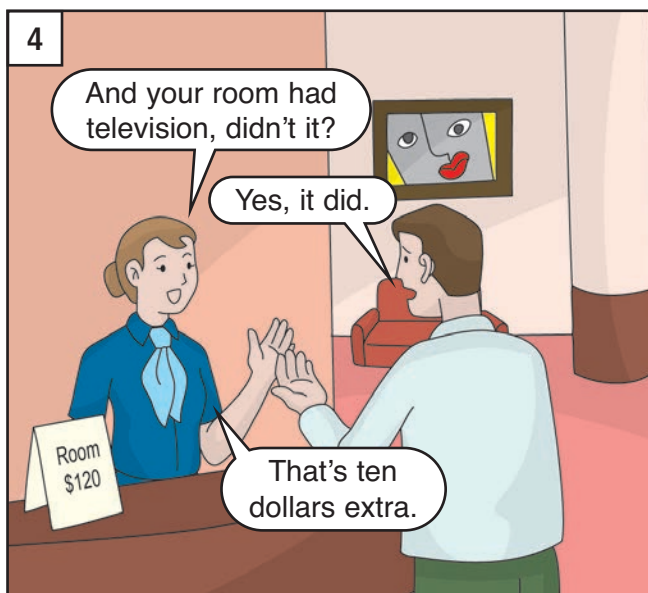
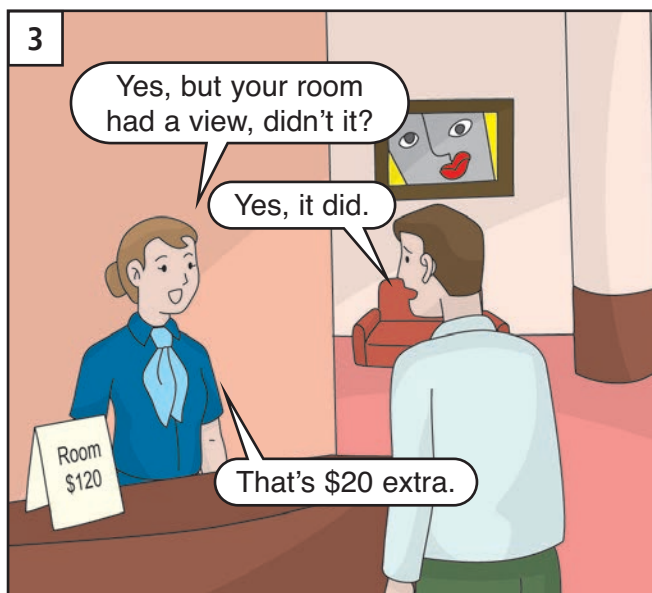
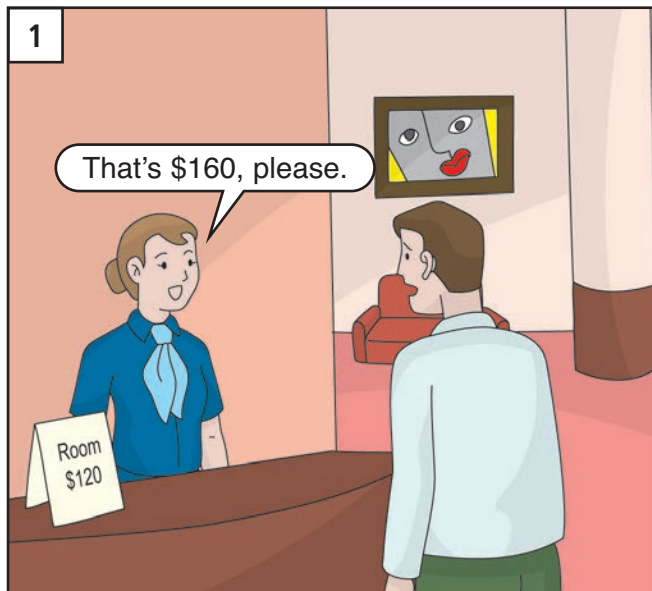

Ten dollars extra.



UNIT 8

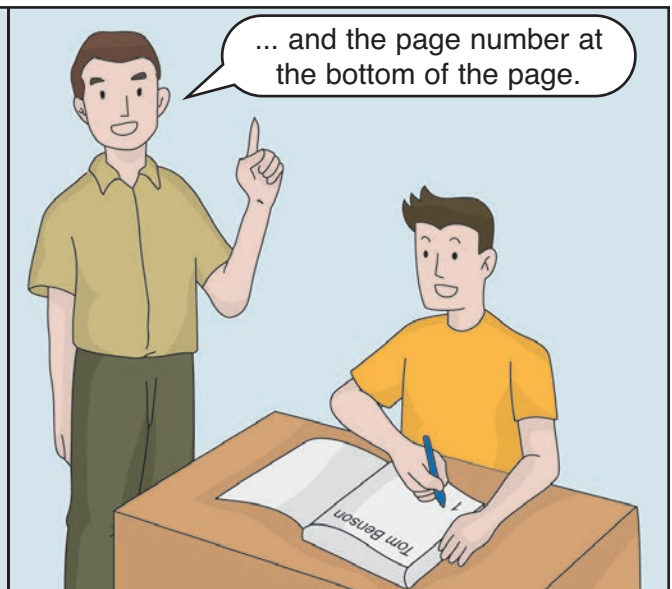
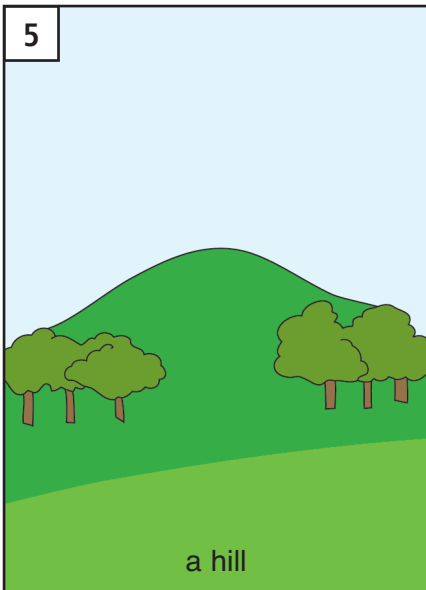
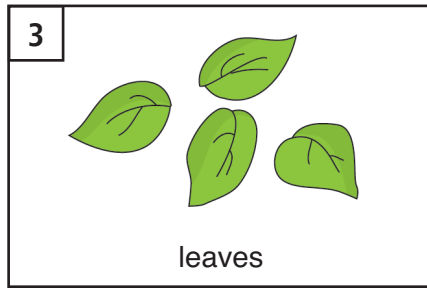
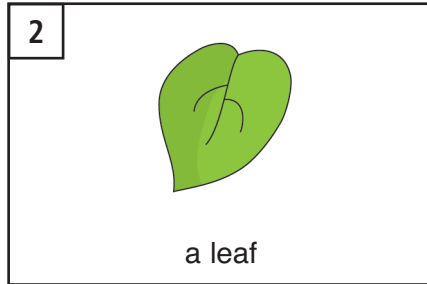
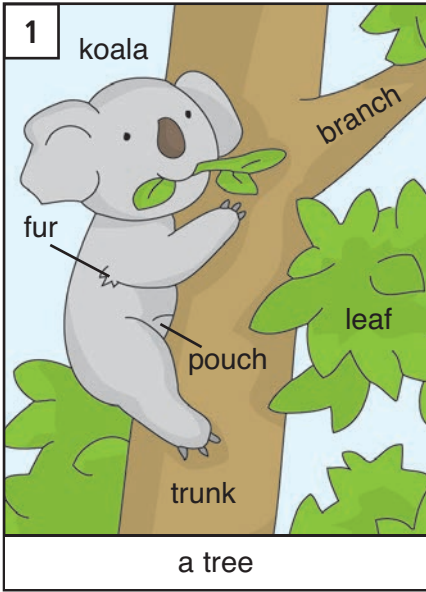

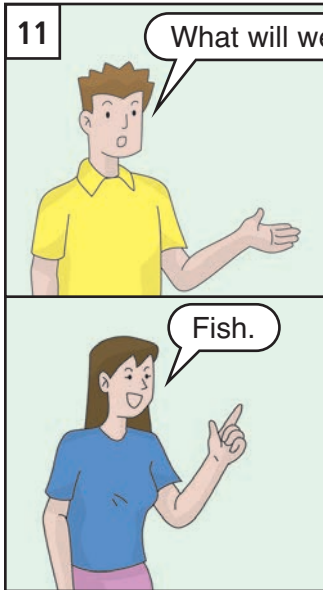
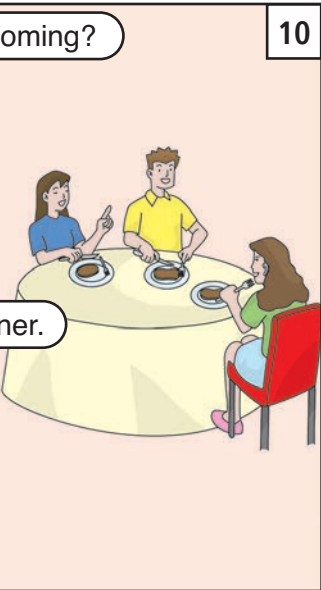
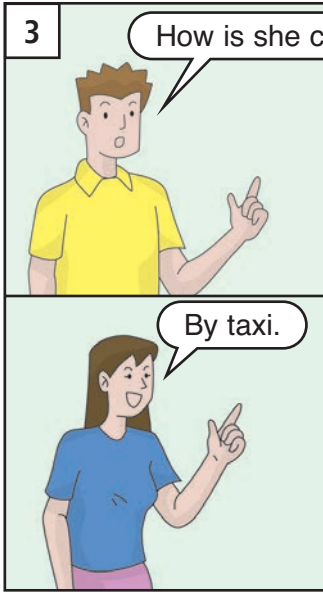
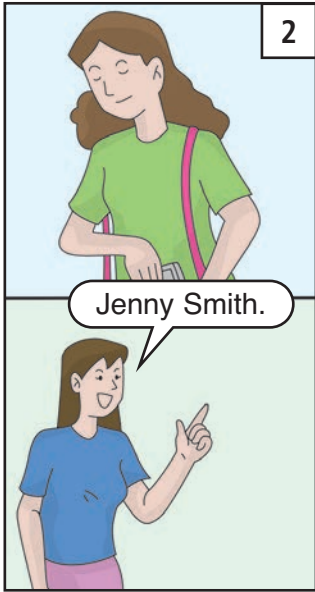

# The Bensons



The Bensons are at the Zoo with Kim and Sue.

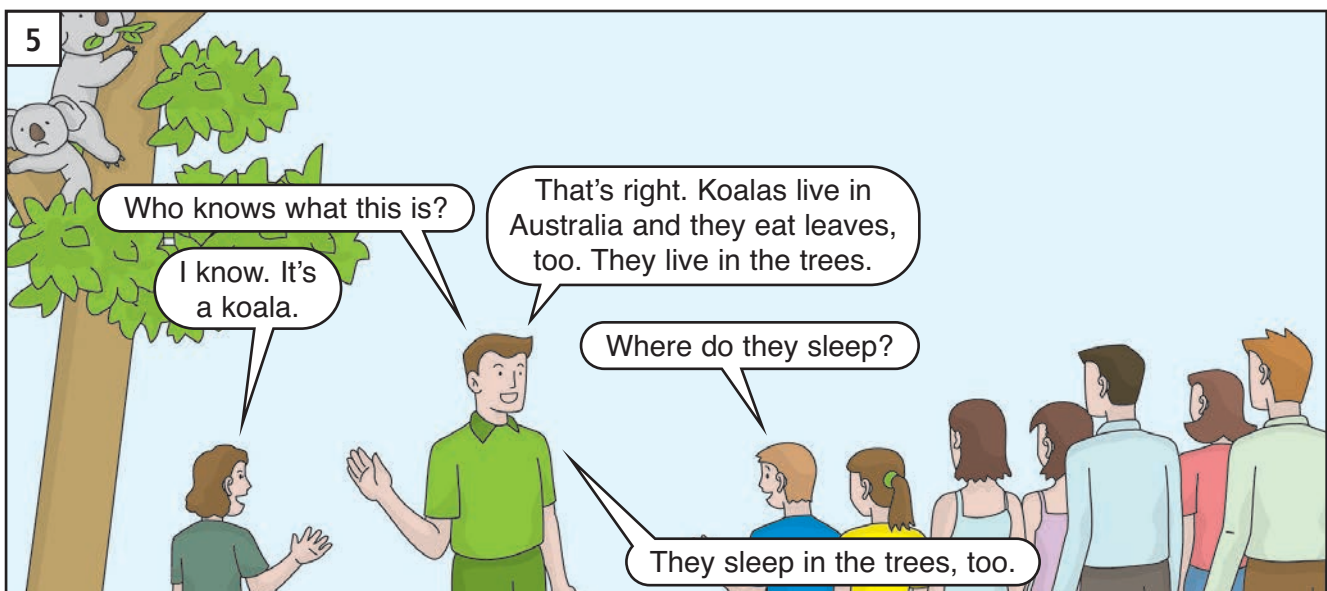
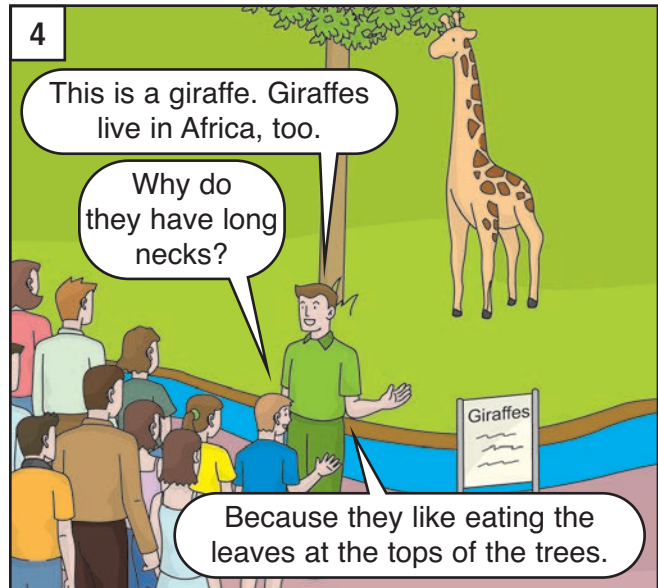
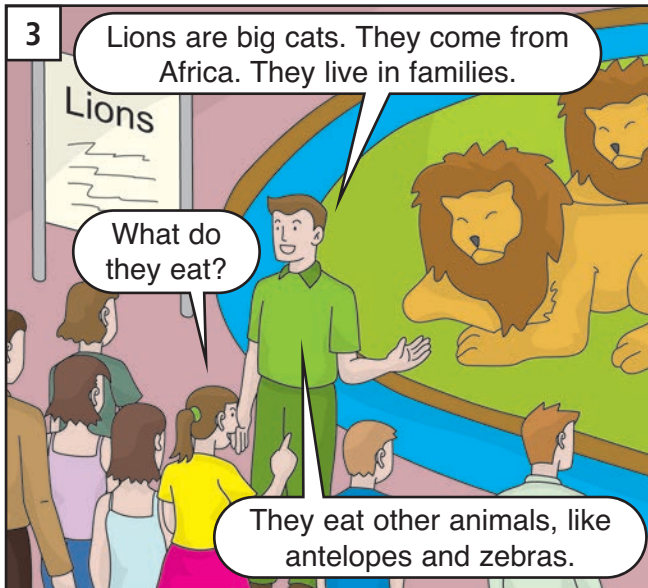
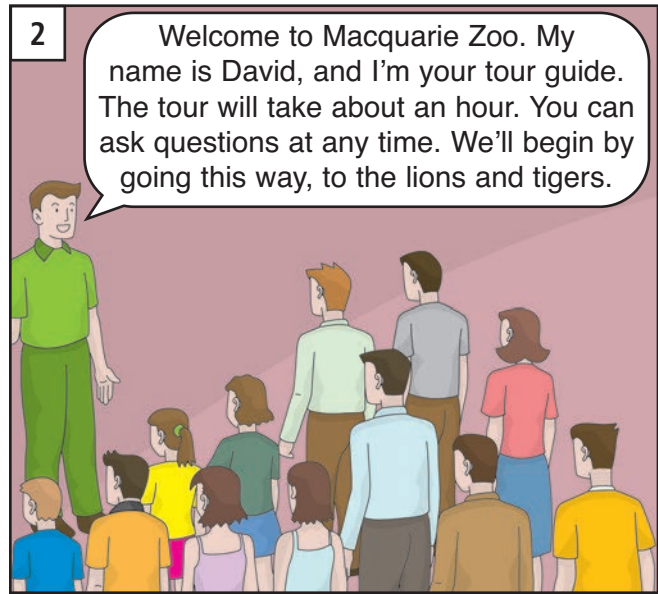

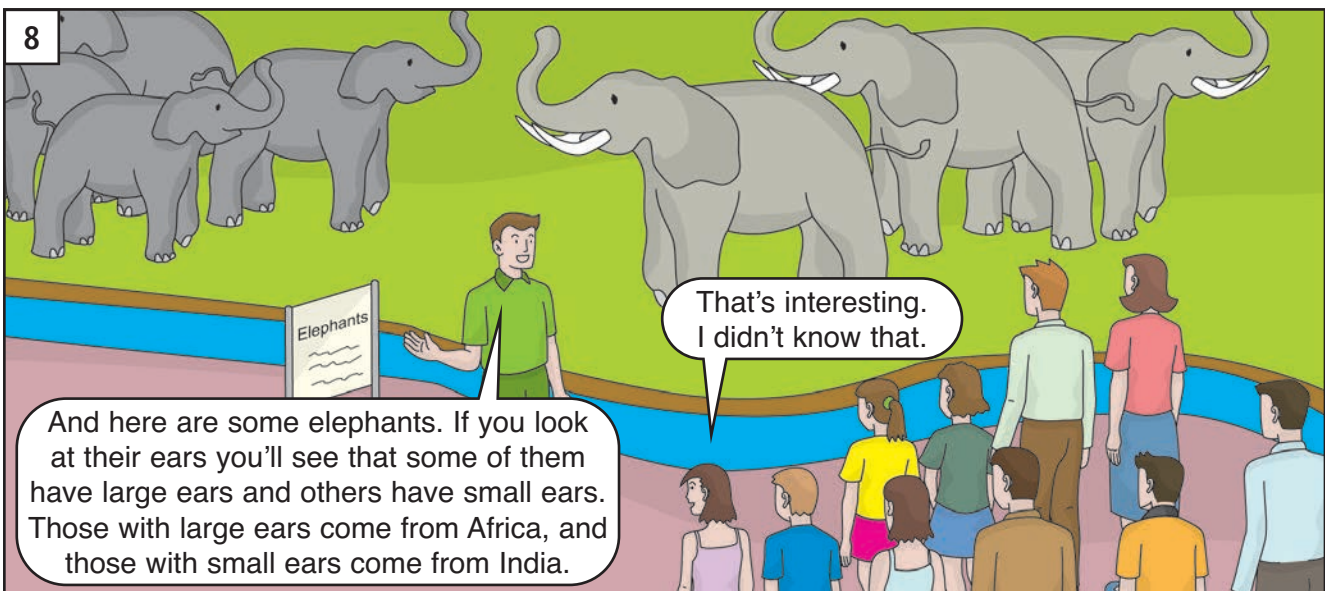

# UNIT 9: Where is Sue?

vending machine  
hotel lobby

room service

not ... enough

on  
beside  
behind  
around  
over  
under  
in front of

open  
closed

horse  
jockey  
race

maybe  
might  
possibly  
probably

boxer  
fight

walk  
stand  
run  
crawl  
fly  
lie  
sit

wardrobe

close  
far  
further

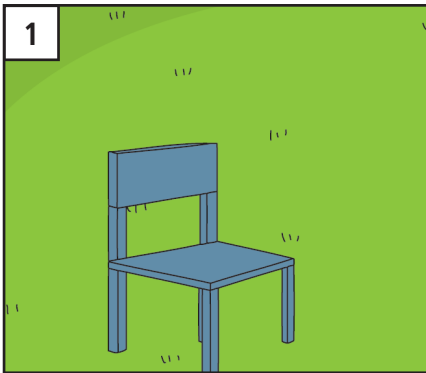

1

a chair

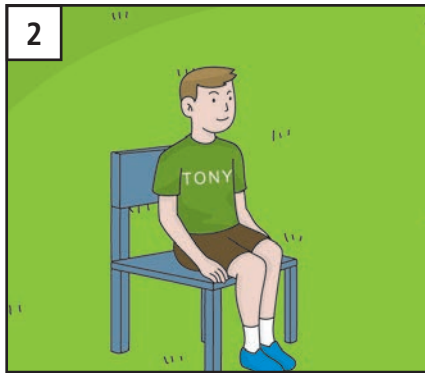

2

Tony's sitting on it.

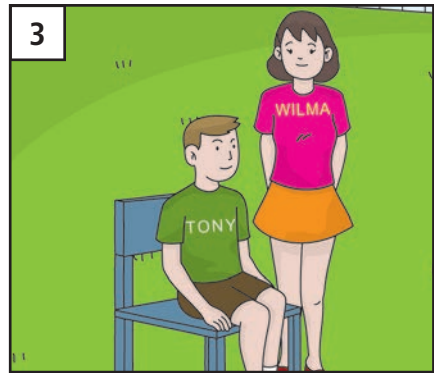

3

Wilma's standing beside it.

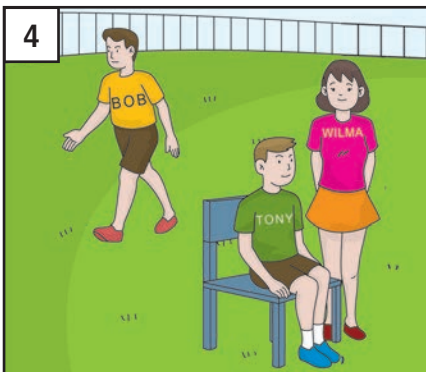

4

Bob's walking behind it.

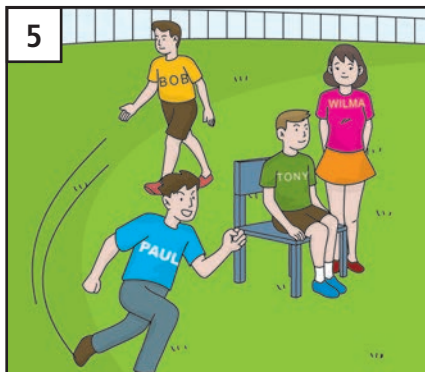

5

Paul's running around it.



6

A bird's flying over it.



A baby's crawling under it.



A dog's lying in front of it.



John's taking a picture of it.

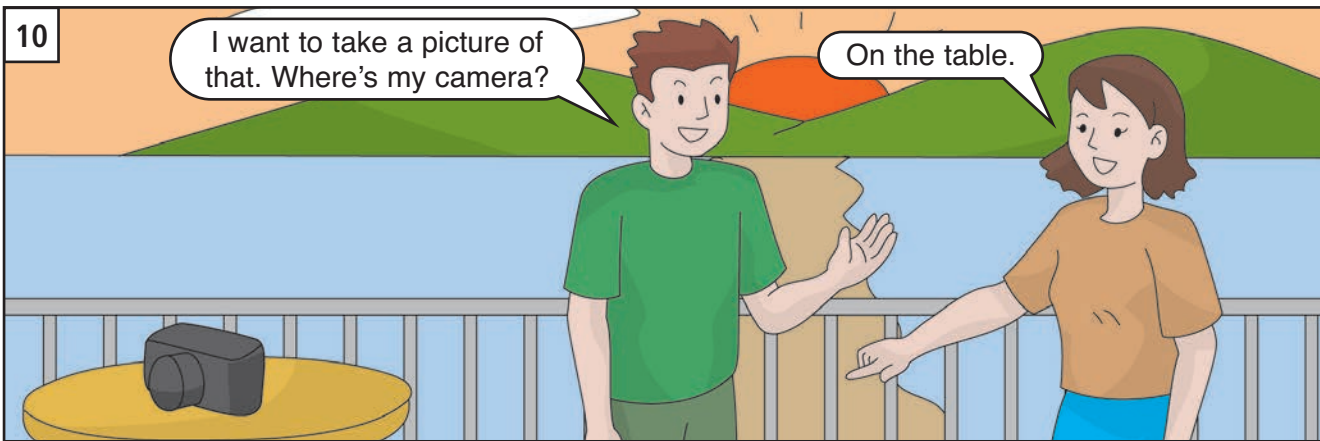

I want to take a picture of that. Where's my camera?

On the table.

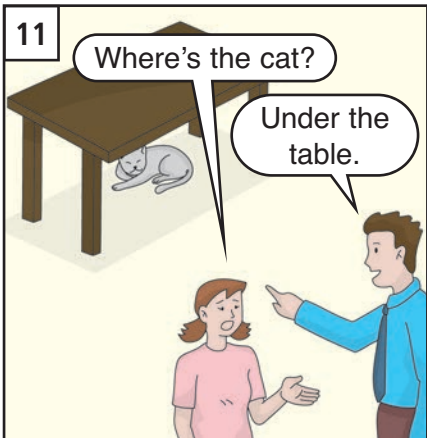

Where's the cat?

Under the table.



Where's the dog?

\_\_\_\_\_ the sofa.



Where's Jim?

\_\_\_\_\_ his house.

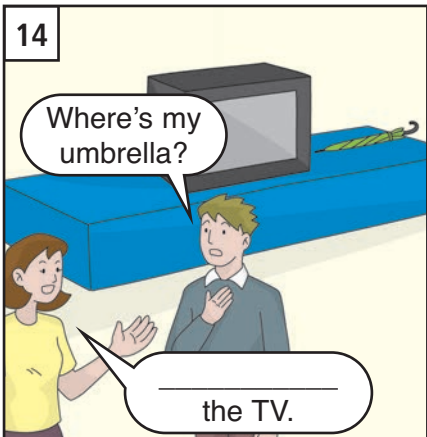

Where's my umbrella?

\_\_\_\_\_ the TV.



Where are my shoes?

\_\_\_\_\_ the bed.

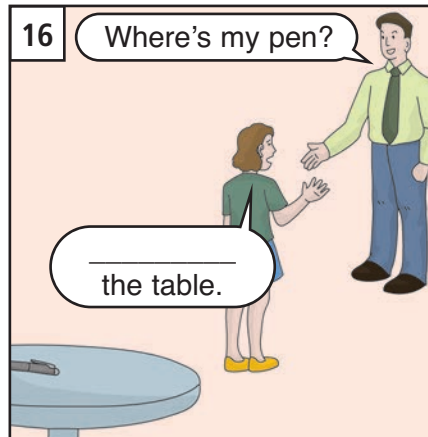

Where's my pen?

\_\_\_\_\_ the table.

UNIT 9

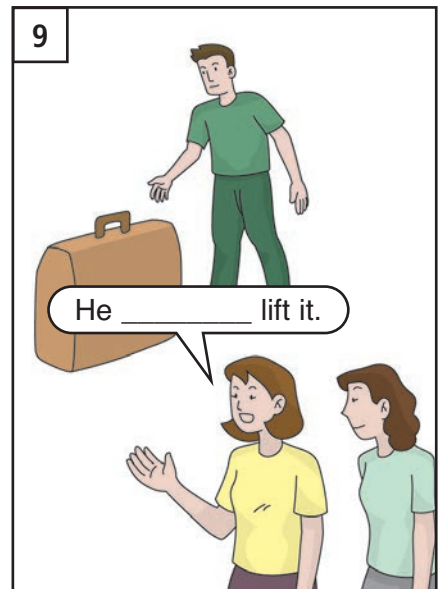
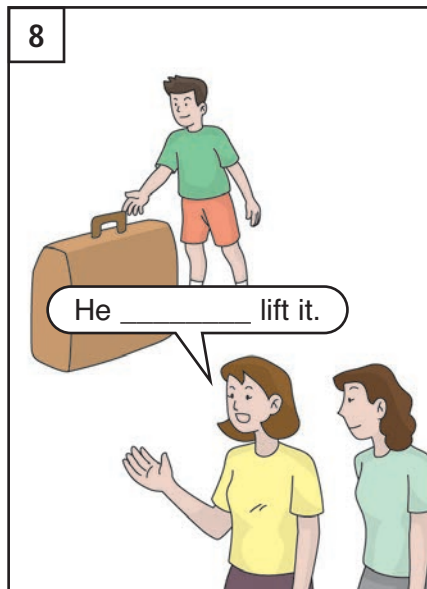
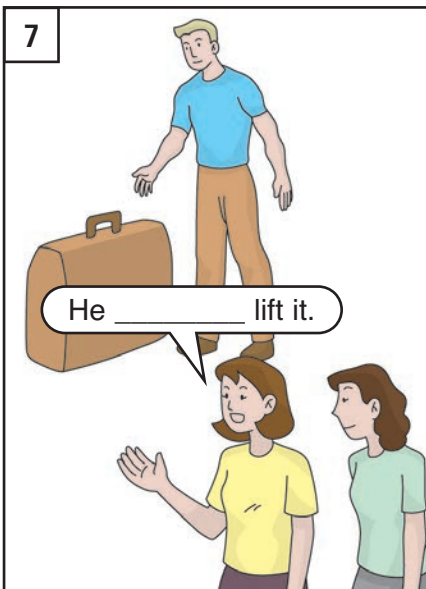
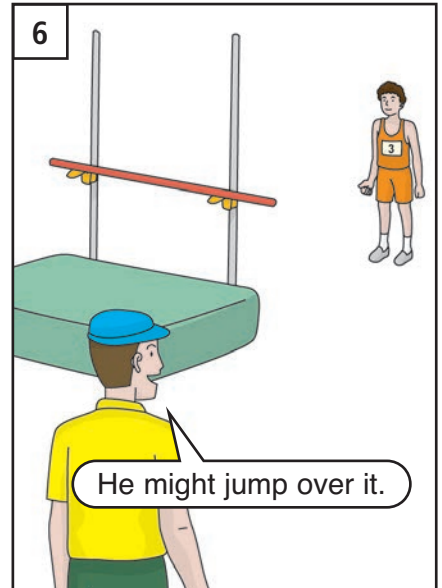
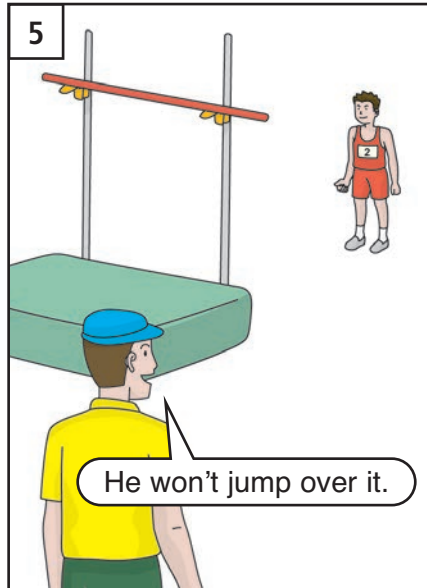
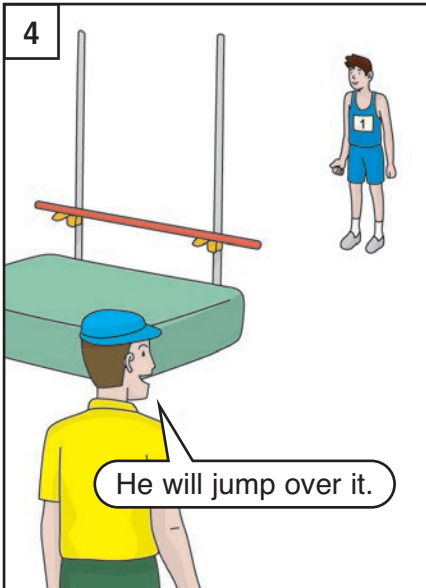

Where is Sue?

1

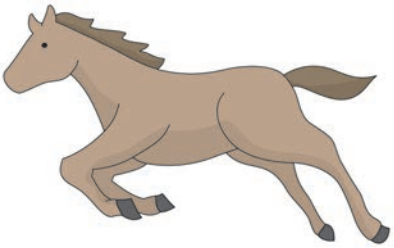

a horse

2



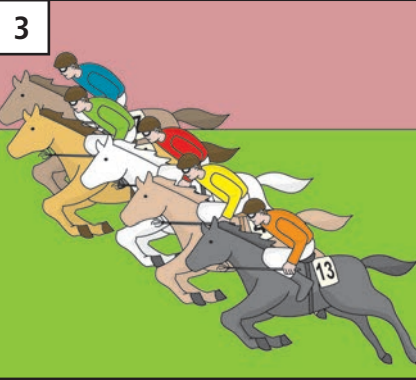

a jockey

3

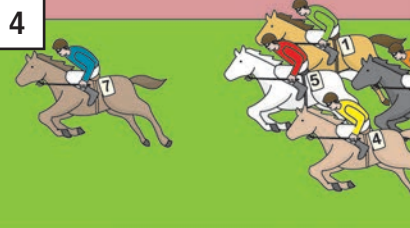

a horse race

4

Will number 7 win? \_\_\_\_\_

5

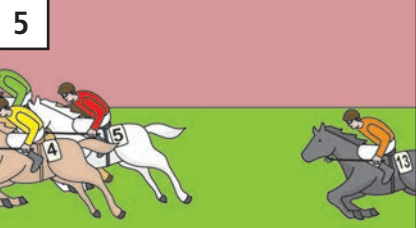

Will number 13 win? \_\_\_\_\_

6



Will number 4 win? \_\_\_\_\_

7



a boxer

8

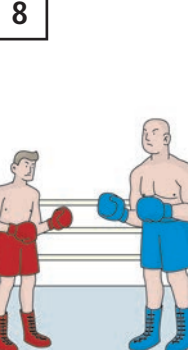

a fight

9

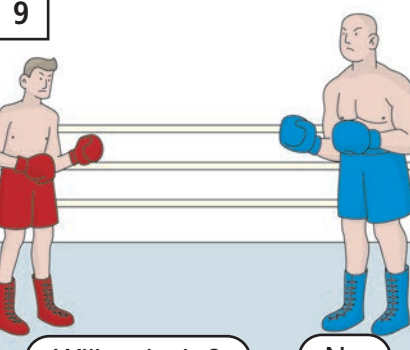

Will red win? No.

10

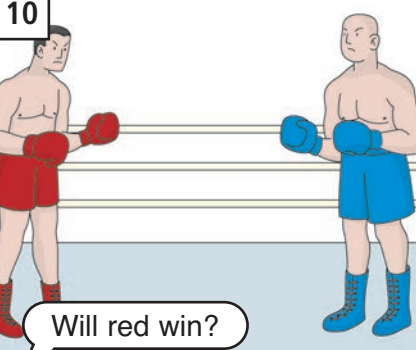

Will red win? Possibly.

11

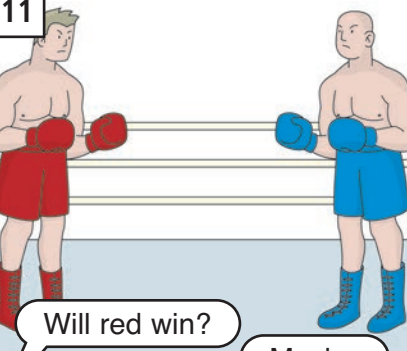

Will red win? Maybe.

12

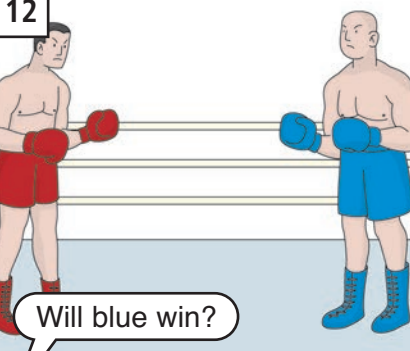

Will blue win? Possibly.

13

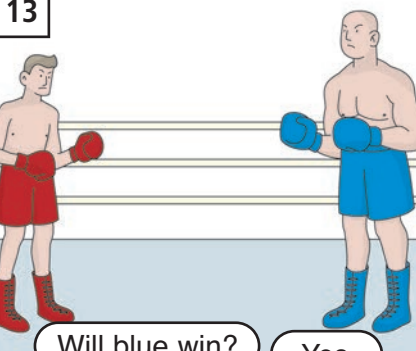

Will blue win? Yes.

UNIT 9

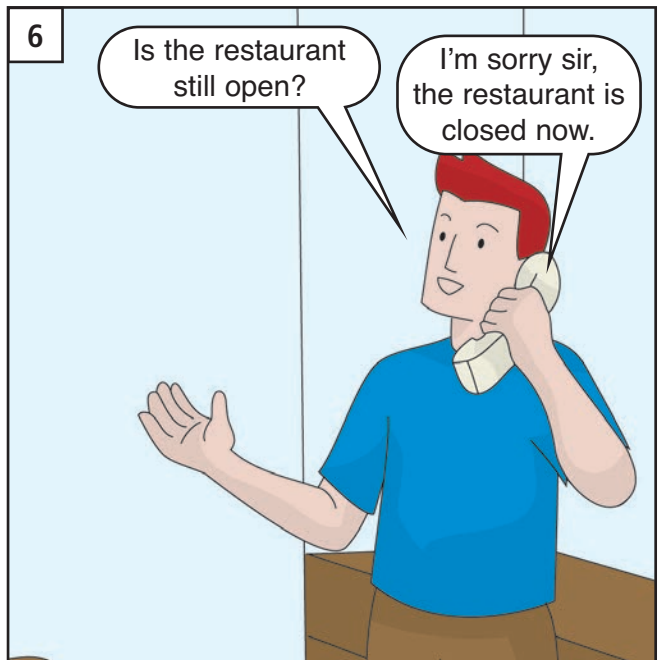
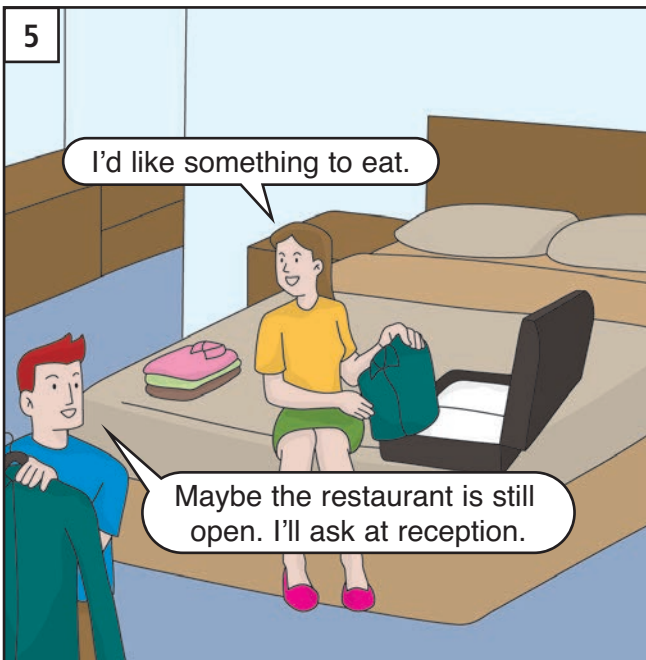
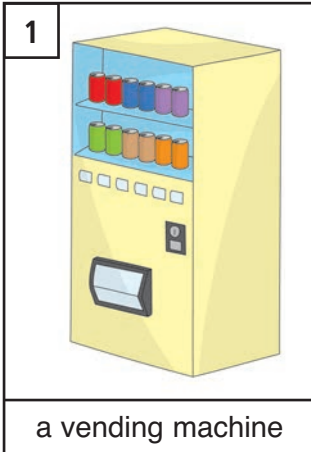

Where is Sue?

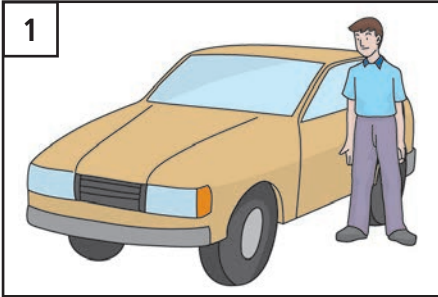

It's a big car.

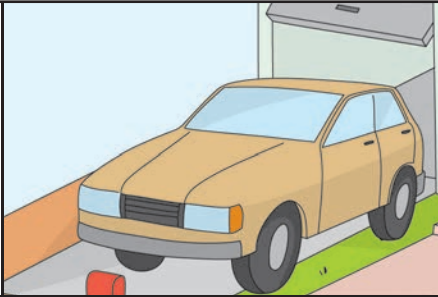

It's too big.



It's not big enough.

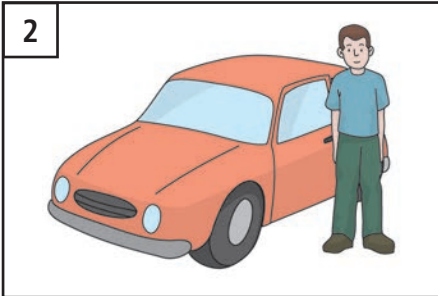

It's a small car.

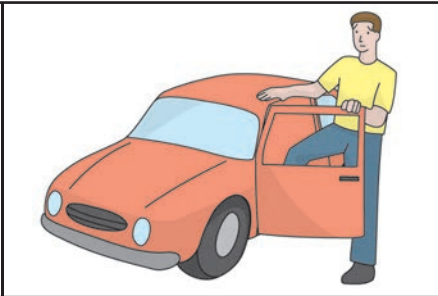

It's too small.

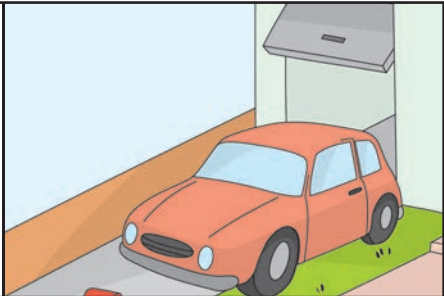

It's not small enough.



It's loud music.

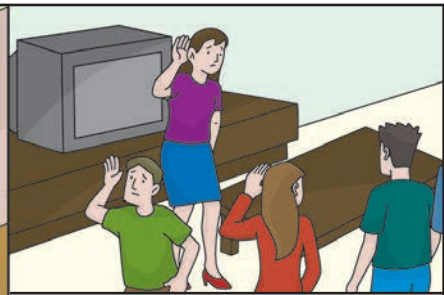

It's not loud enough.

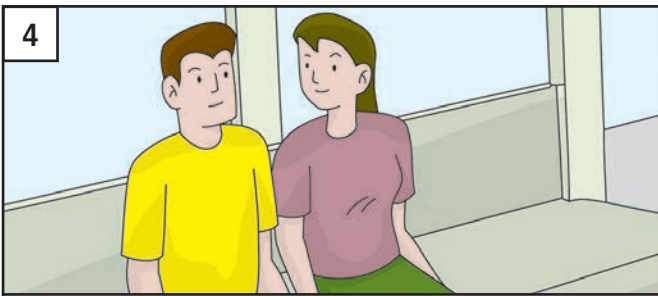

close together

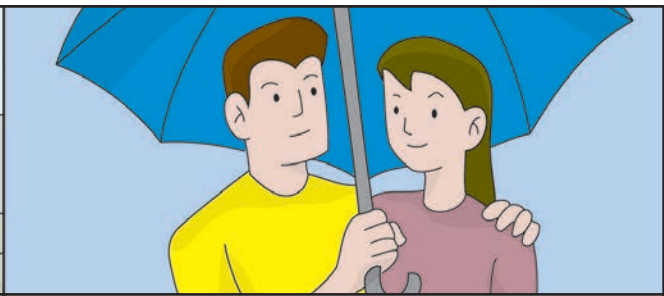

closer together

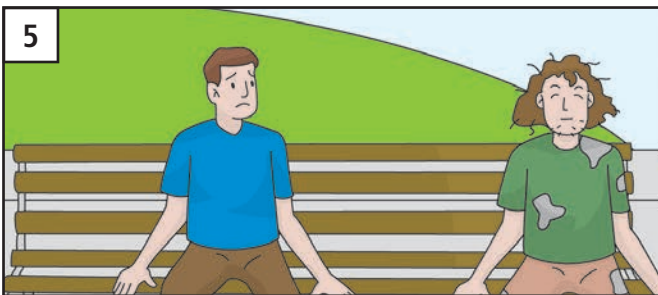

far apart

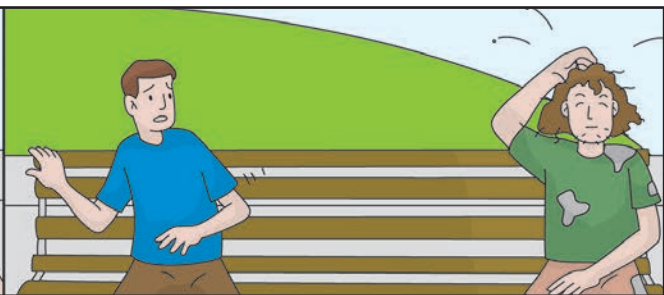

further apart

# The Bensons

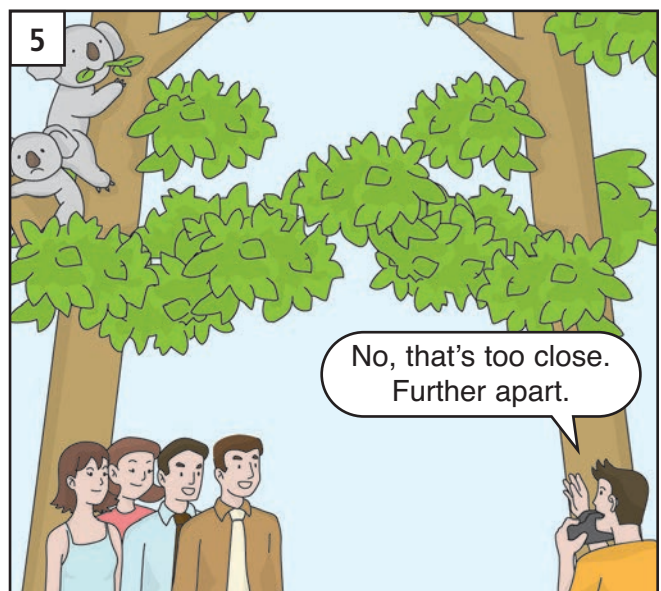
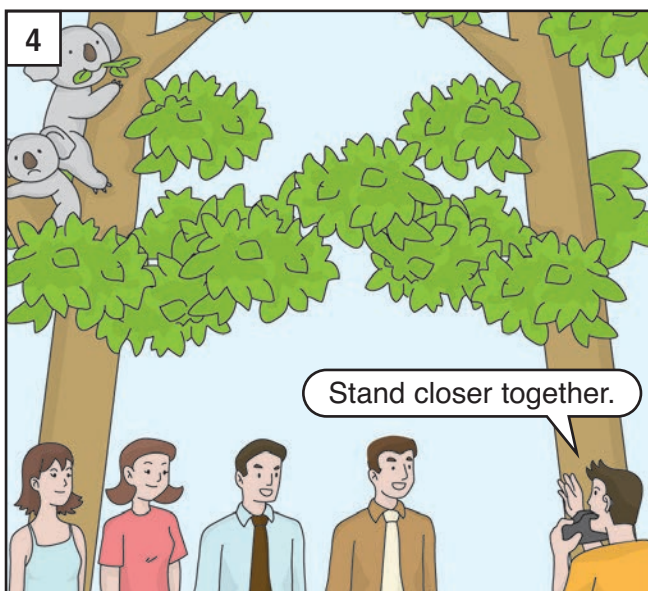
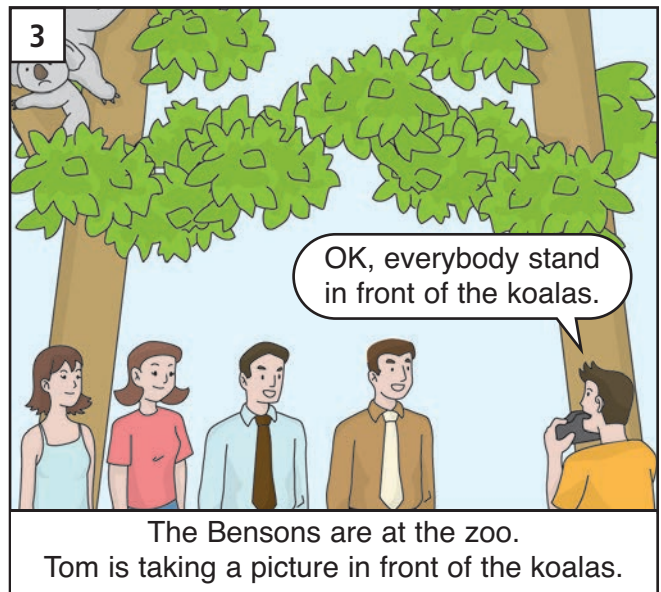
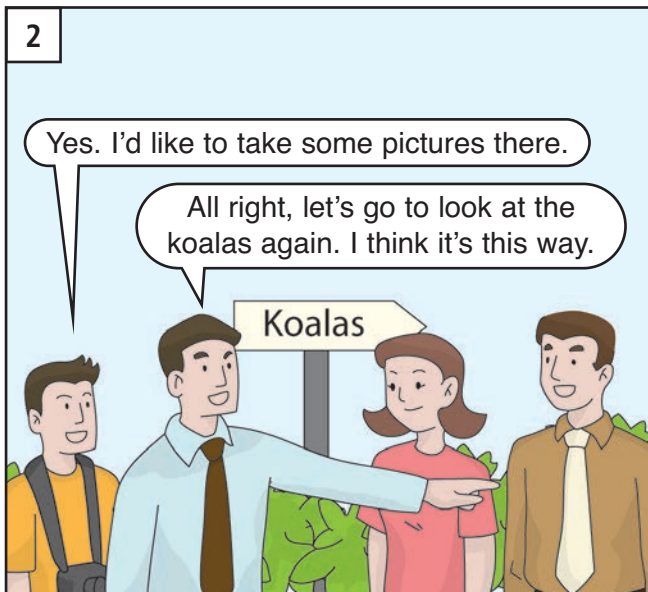
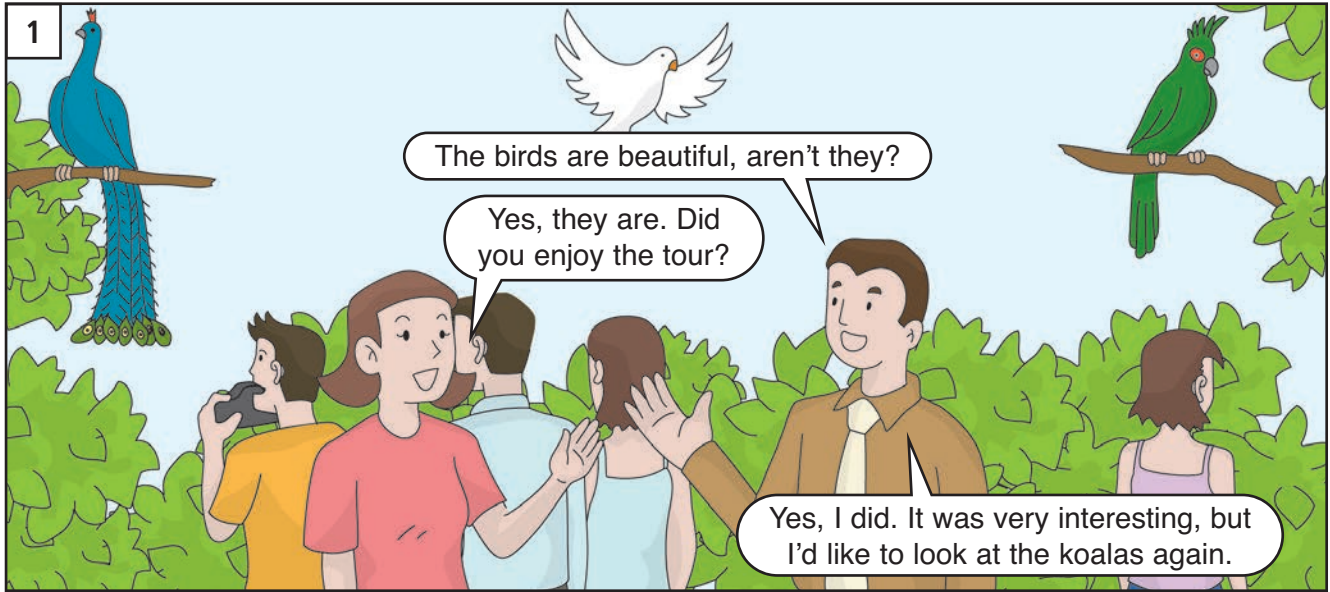

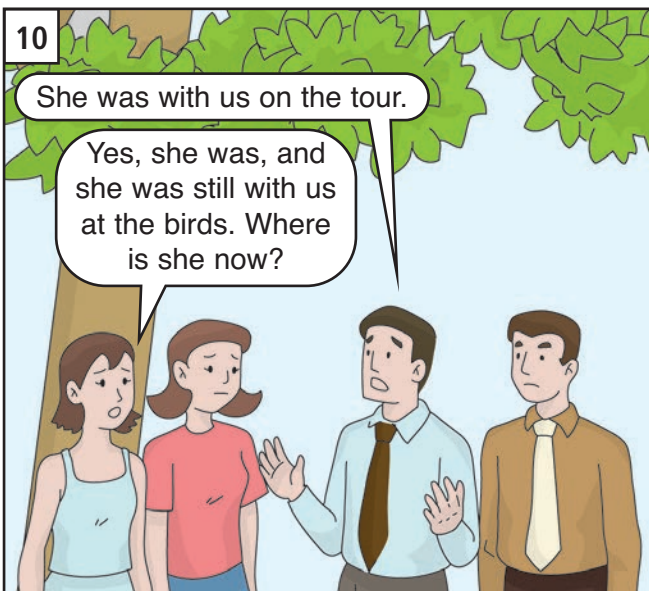
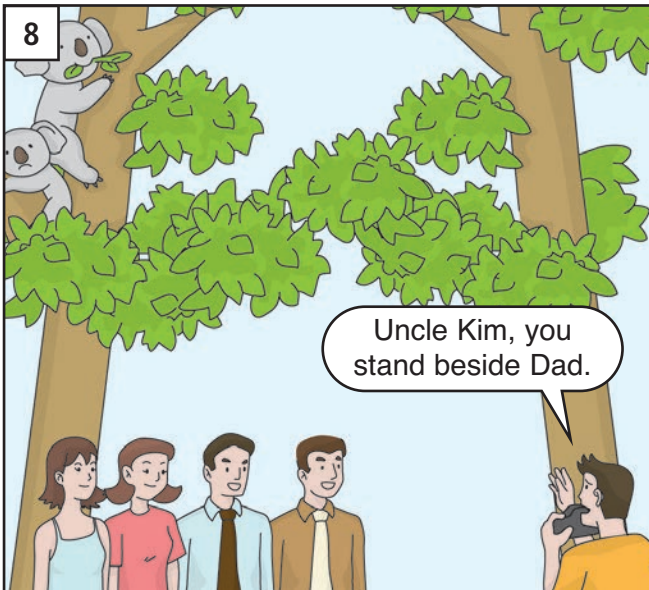
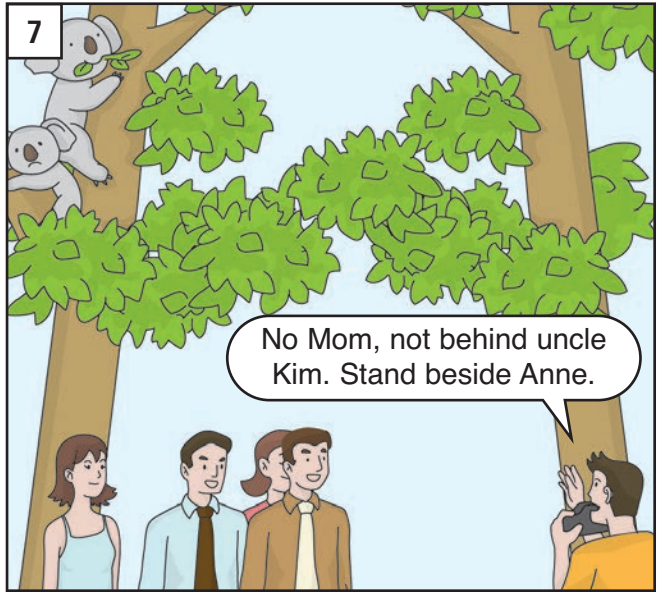
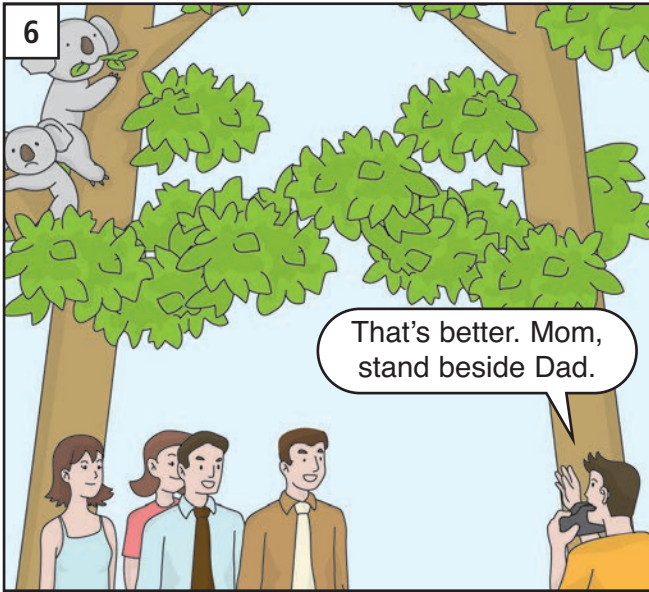

# UNIT 10: Revision and extension

1



radio

.....

2

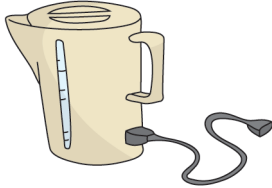

.....

3

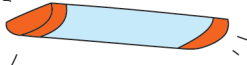

.....

4

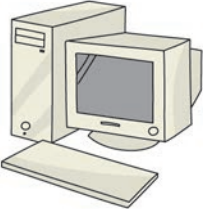

.....

5

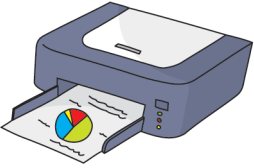

.....

6

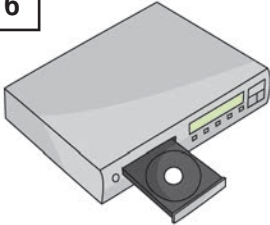

.....

7

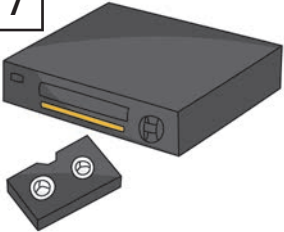

.....

8

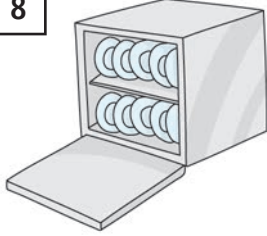

.....

9

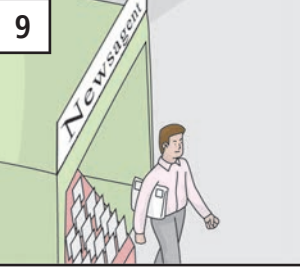

.....

10



.....

11

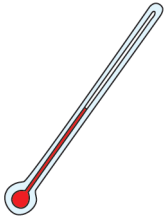

.....

12

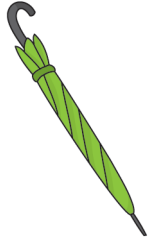

.....

13

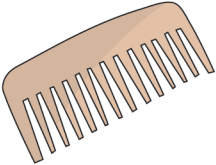

.....

14

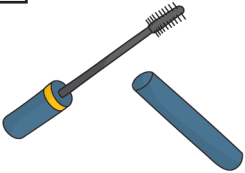

.....

15

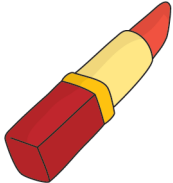

.....

16



.....

17

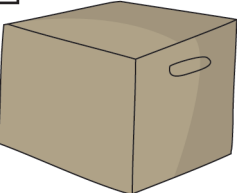

.....

18

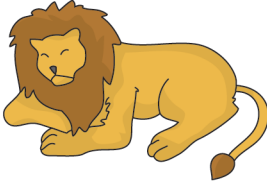

.....

19

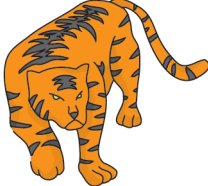

.....

20



.....

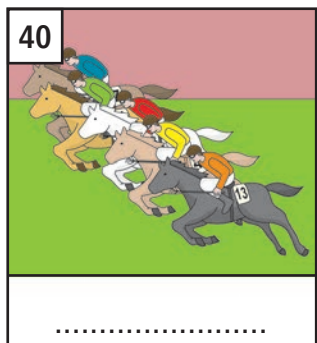
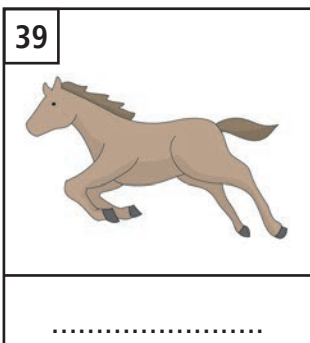
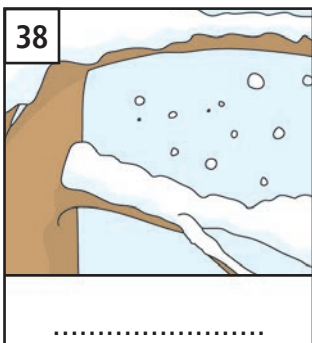
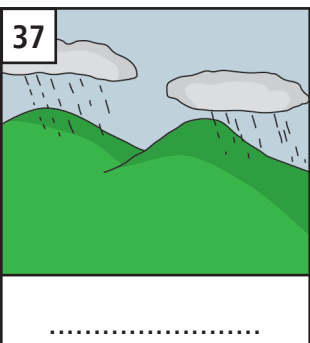
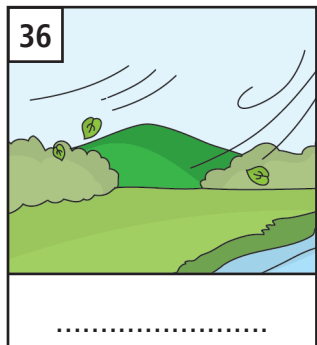
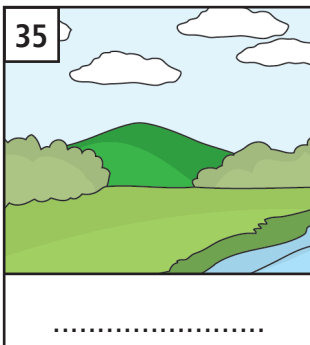
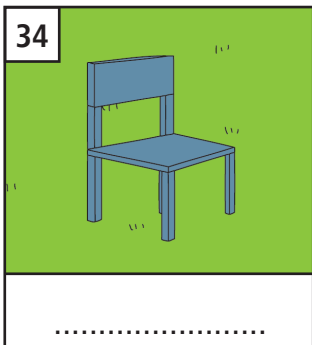
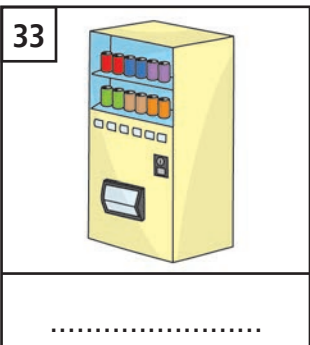
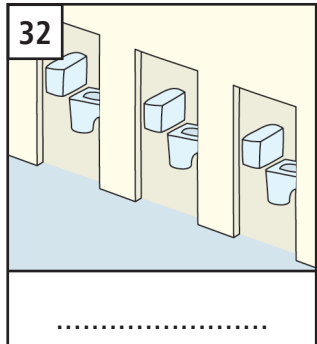
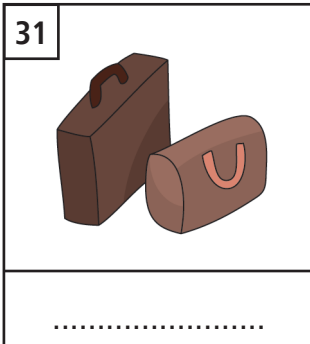
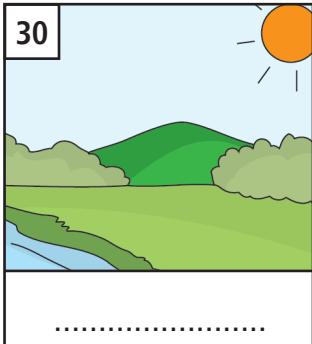
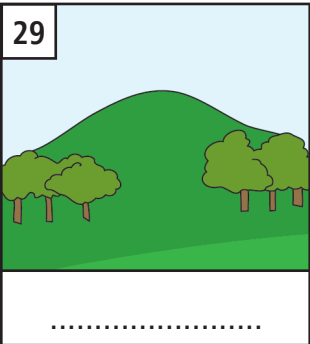
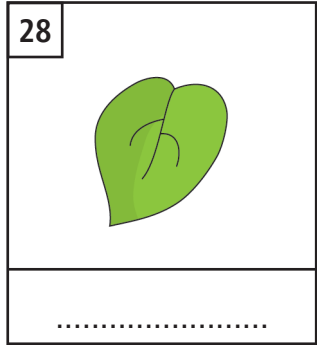
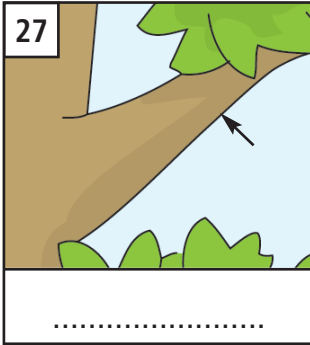
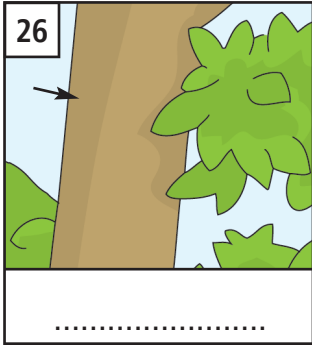
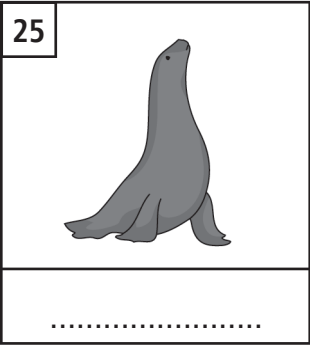
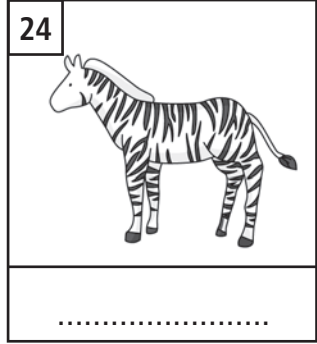
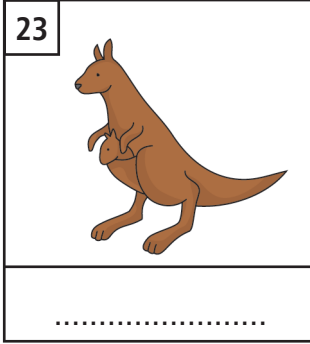
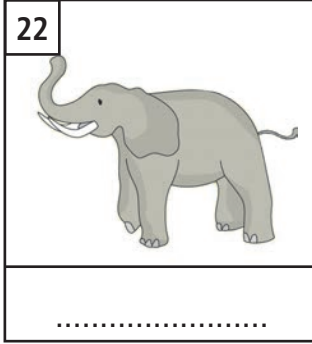
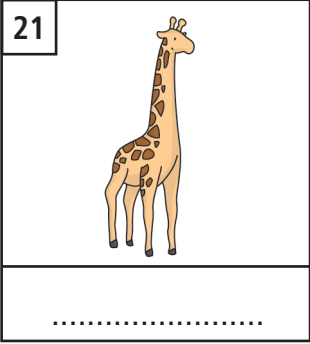

## UNIT 10

### A

- |  |                        |
|--|------------------------|
| 1. I'd rather watch TV than go swimming. | a. Single or return?   |
| 2. Can I help with the dishes?           | b. Almost.             |
| 3. Have you got your suitcase?           | c. So would I.         |
| 4. Are you ready to go?                  | d. Yes, I have.        |
| 5. Two to the airport, please.           | e. No, it's all right. |

### B

- |                                 |                                     |
|---------------------------------|-------------------------------------|
| 1. Where's the camera?          | a. At a quarter past two.           |
| 2. I never watch TV.            | b. I've got it.                     |
| 3. Why did you buy a new house? | c. Beside the entrance.             |
| 4. What time are we leaving?    | d. I didn't know that.              |
| 5. Where are the toilets?       | e. Because we needed more bedrooms. |

### C

- |                              |                       |
|------------------------------|-----------------------|
| 1. Do you watch sport on TV? | a. I'll turn it down. |
| 2. When does the news start? | b. I forgot them.     |
| 3. The radio's too loud.     | c. Six o'clock.       |
| 4. Can you turn the TV off ? | d. Sometimes.         |
| 5. Where are the tickets?    | e. Sure.              |

### D

- |                                  |                                    |
|----------------------------------|------------------------------------|
| 1. What channel's the movie on?  | a. At one thirty.                  |
| 2. Can you turn the printer off? | b. This one.                       |
| 3. We'd like to join a tour.     | c. That'll be twelve dollars each. |
| 4. When does the tour finish?    | d. Channel seven.                  |
| 5. Which video would you like?   | e. Where's the switch?             |

in      channel      open      about      where      beside      on



UNIT 10

without    might    rather    instead    down    enough    like    so

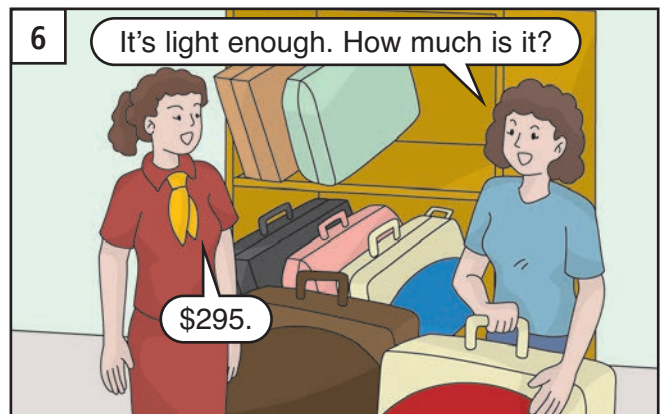

does take open extra start from tours before

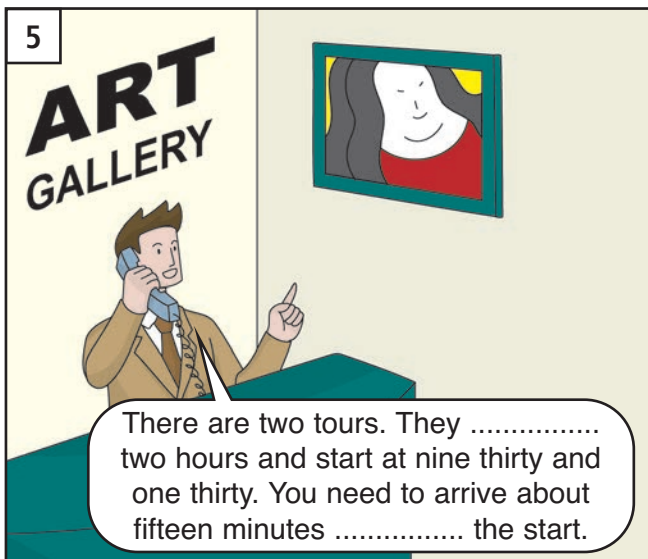
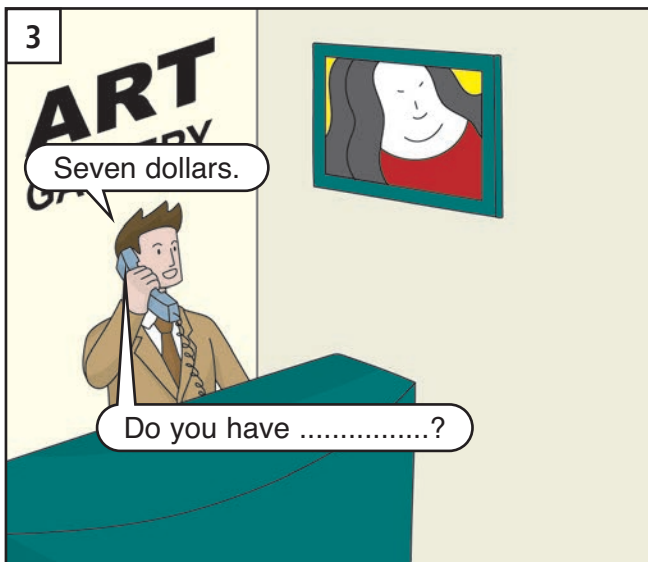
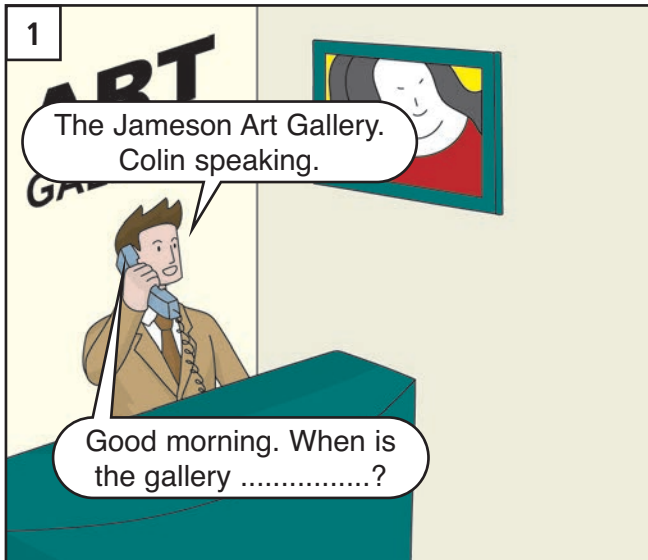

UNIT 10

get

When

arriving

finish

Where

Why

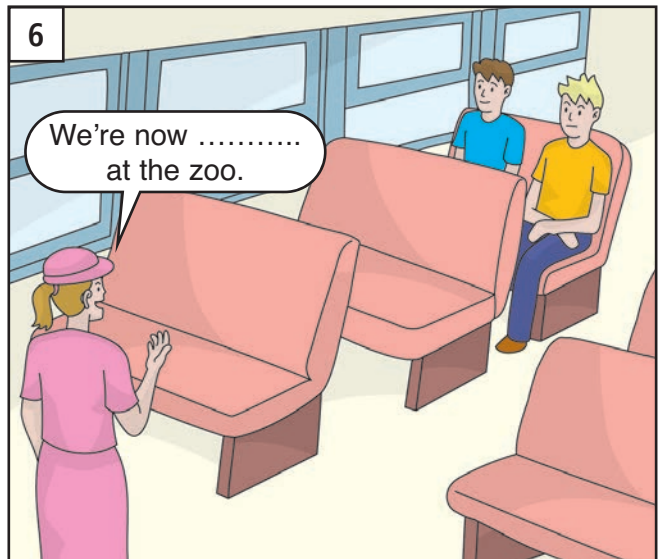
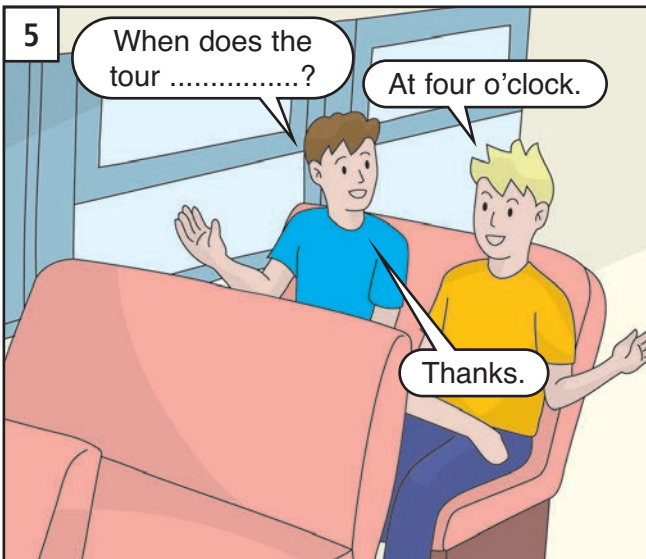
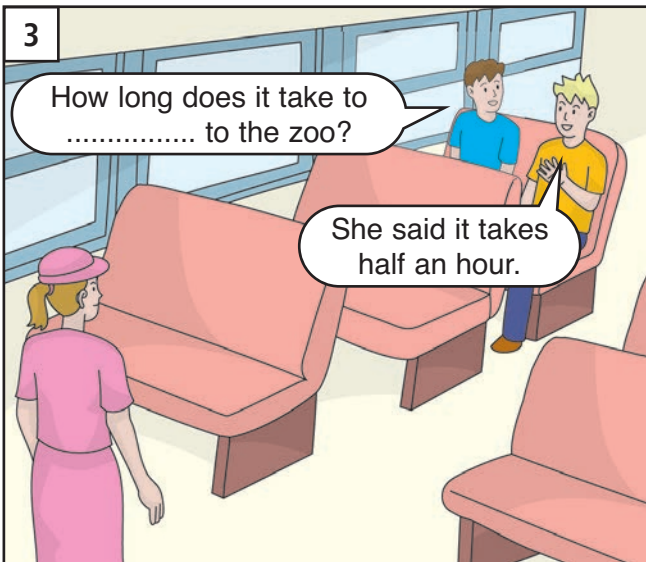
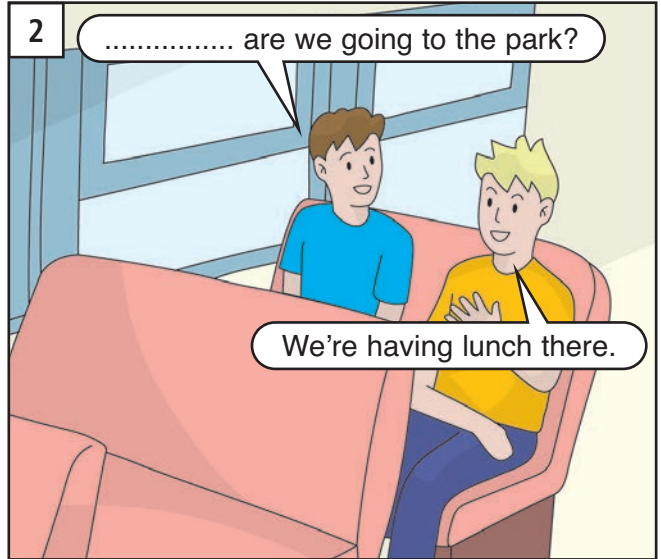

Revision and extension

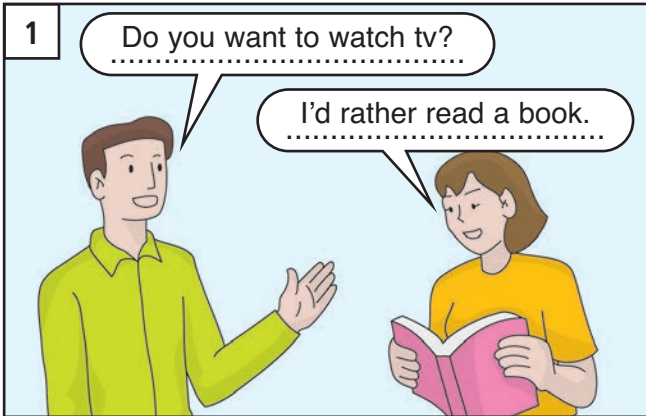

- > want watch to TV you Do
- > rather I'd a book read

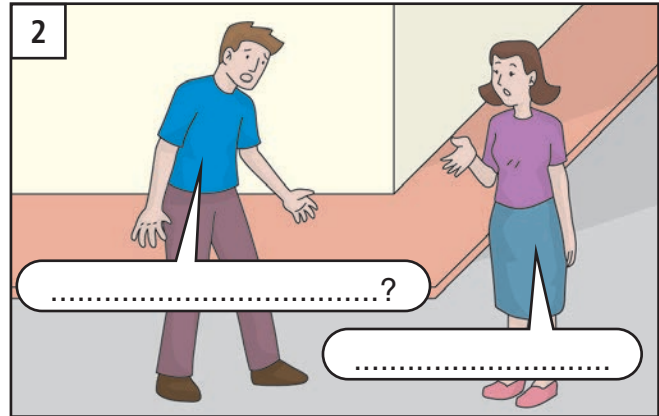

- > wallet Where's my
- > forgot Maybe it you

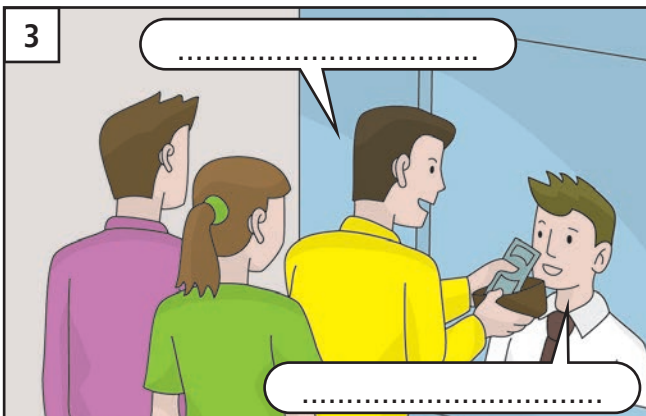

- > to city Three the please
- > two each dollars That's



- > is Where telephone the
- > reception Beside

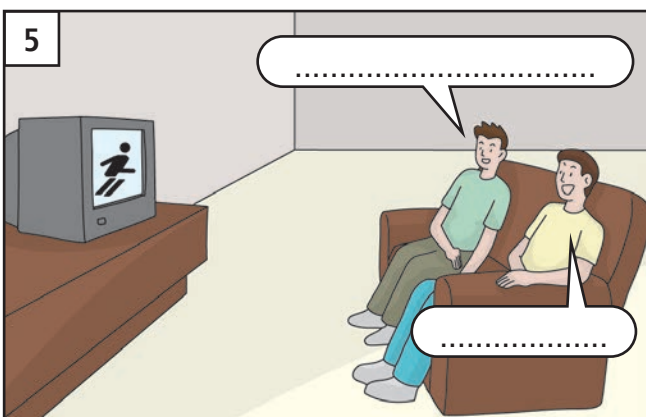

- > I watching sport like
- > So I do



- > start does When the movie
- > news the After

UNIT 10

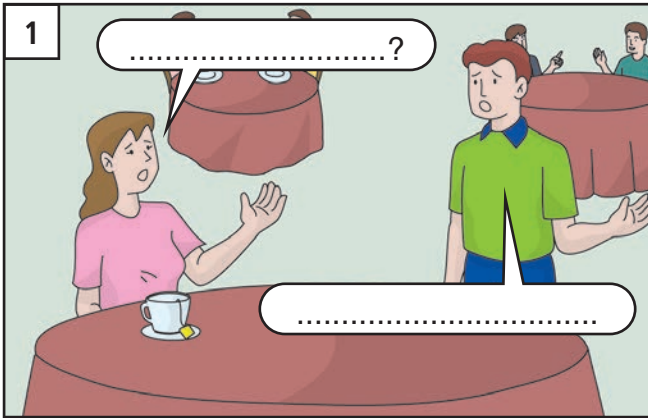

- > late you Why are
- > wrong went the restaurant I to

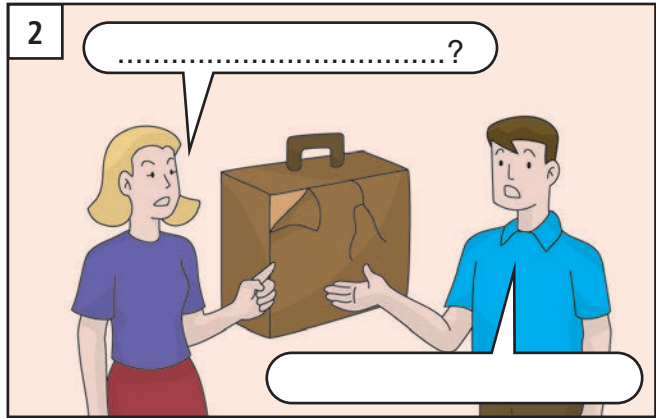

- > buy suitcase we Can a new
- > enough we got Have money



- > taxi get Where I a can
- > hotel the of front In



- > a tour join like to I'd
- > tour next starts The nine o'clock at

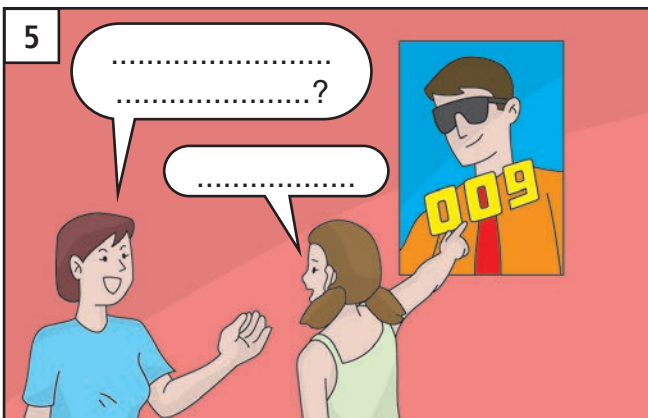

- > would see you like movie Which to
- > one This

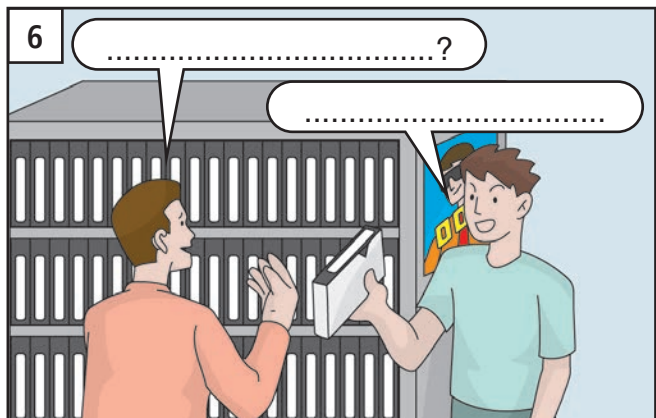

- > video do that Why you want
- > It be might interesting.

## Answers to Unit 10

### Unit 10, page 86

- |                 |              |               |             |               |
|-----------------|--------------|---------------|-------------|---------------|
| 1. radio        | 2. kettle    | 3. light      | 4. computer | 5. printer    |
| 6. CD player    | 7. video     | 8. dishwasher | 9. kiosk    | 10. timetable |
| 11. thermometer | 12. umbrella | 13. comb      | 14. mascara | 15. lipstick  |
| 16. eyelashes   | 17. box      | 18. lion      | 19. tiger   | 20. koala     |

### Unit 10, page 87

- |             |              |                     |           |                |
|-------------|--------------|---------------------|-----------|----------------|
| 21. giraffe | 22. elephant | 23. kangaroo        | 24. zebra | 25. seal       |
| 26. trunk   | 27. branch   | 28. leaf            | 29. hill  | 30. sunny      |
| 31. luggage | 32. toilets  | 33. vending machine | 34. chair | 35. cloudy     |
| 36. windy   | 37. rain     | 38. snow            | 39. horse | 40. horse race |

### Unit 10, page 88

- A. 1c 2e 3d 4b 5a      B. 1b 2d 3e 4a 5c      C. 1d 2c 3a 4e 5b      D. 1d 2e 3c 4a 5b

### Unit 10, page 89

1. channel, where      2. beside, about      3. on      4. in, open

### Unit 10, page 90

1. like      2. enough      3. down      4. rather, might      5. so      7. without      8. instead

### Unit 10, page 91

1. open      2. from, does      3. tours      4. extra, start      5. take, before

### Unit 10, page 92

1. Where      2. Why      3. get      4. When      5. finish      6. arriving

### Unit 10, page 93

- Do you want to watch TV?  
I'd rather read a book.
- Where's my wallet?  
Maybe you forgot it.
- Three to the city please.  
That's two dollars each.
- Where is the telephone?  
Beside reception.
- I like watching sport.  
So do I.
- When does the movie start?  
After the news.

### Unit 10, page 94

- Why are you late?  
I went to the wrong restaurant.
- Can we buy a new suitcase?  
Have we got enough money?
- Where can I get a taxi?  
In front of the hotel.
- I'd like to join a tour.  
The next tour starts at nine o'clock.
- Which movie would you like to see?  
This one.
- Why do you want that video?  
It might be interesting.

# UNIT 11: I'm wearing one, too.

yourself  
myself  
herself  
yourselves  
themselves  
ourselves  
himself

dress wear

clean  
dirty  
torn  
burnt  
hole  
mark  
creased

wardrobe  
dresser  
chest of drawers

jeans shirt  
tie socks  
dress skirt  
tee shirt jumper  
jacket coat  
suit hat  
pants bra  
trousers stockings

work  
doesn't work

top drawer  
bottom drawer

fall

might be  
must be  
in case  
worried

<p>1</p> <p>Come here Anna, and I'll dress you.</p>	<p>Where's Mom? She's dressing Anna.</p>	<p>Anna, go and dress yourself.</p>
1992		1996

<p>2</p> <p>Where's Anna? She's in her bedroom. She's dressing herself.</p>	<p>Anna, where are you? I'm in my bedroom. I'm dressing myself.</p>	<p>3</p> <p>We're dressing ourselves. They're dressing themselves.</p>
---	---	--

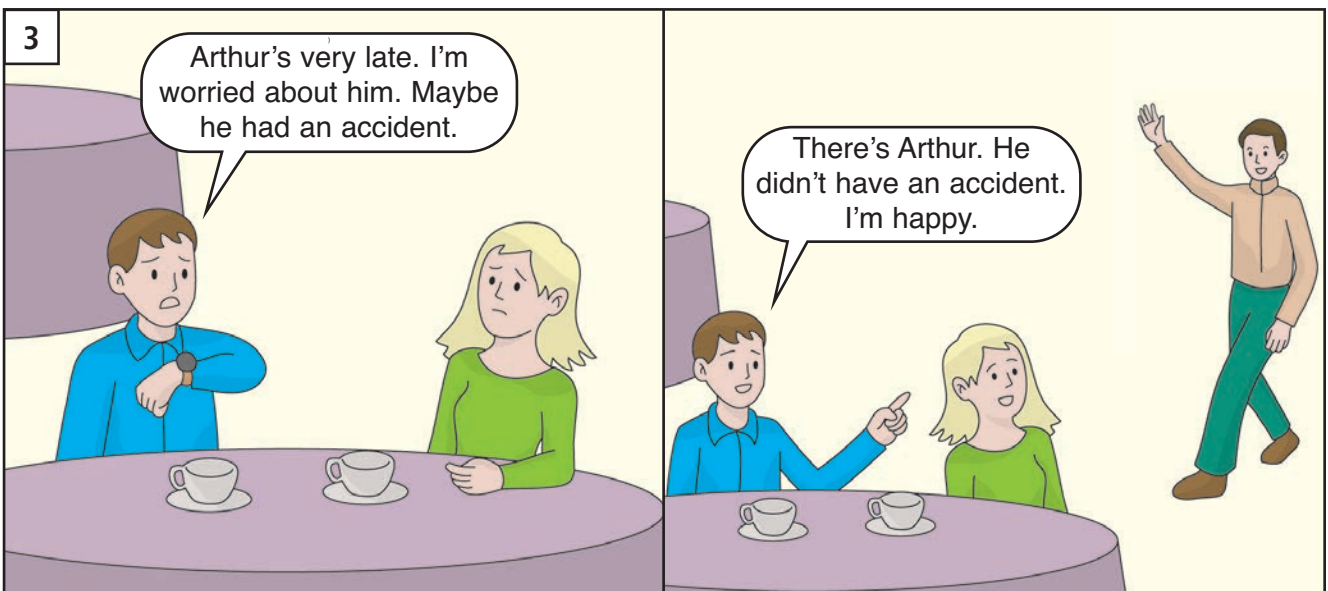



I'm wearing one, too.

1

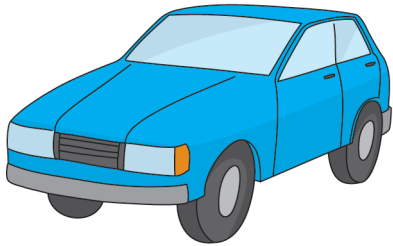

It's clean.

2

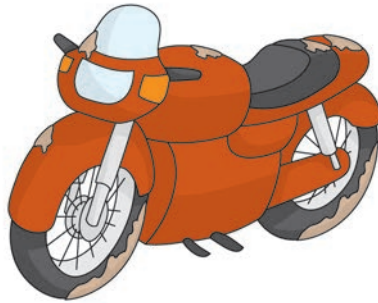

It's dirty.

3

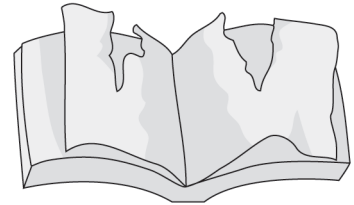

It's torn.

4

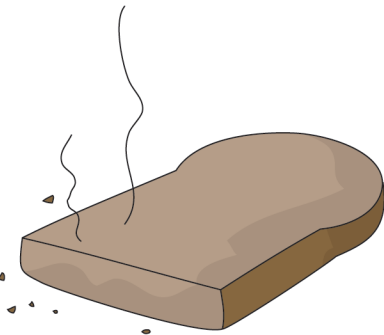

It's burnt.

5

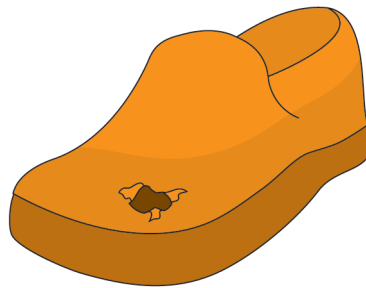

There's a hole in it.

6



There's a mark on it.

7



They're creased.

8

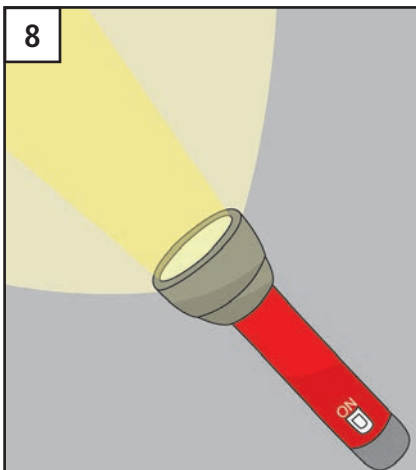

It works.

9

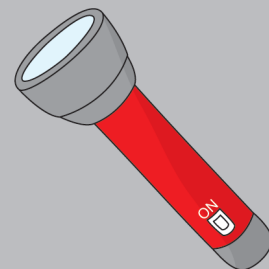

It doesn't work.

UNIT 11

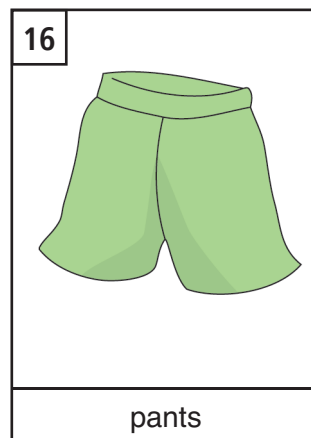
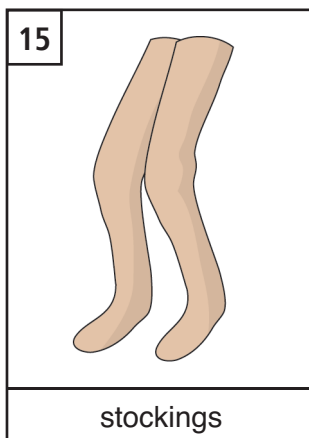
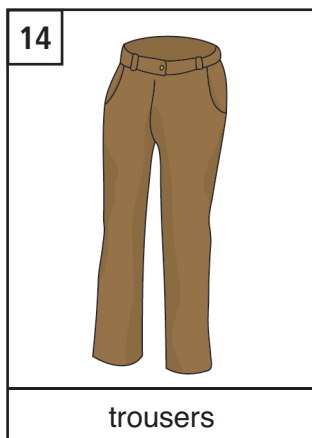
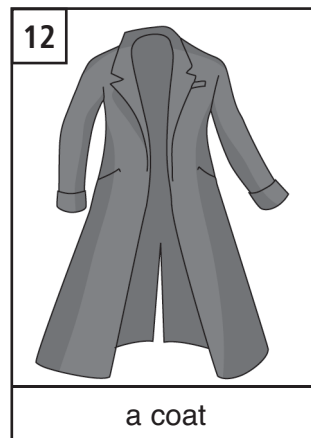
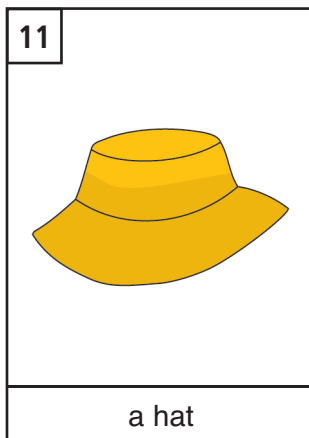
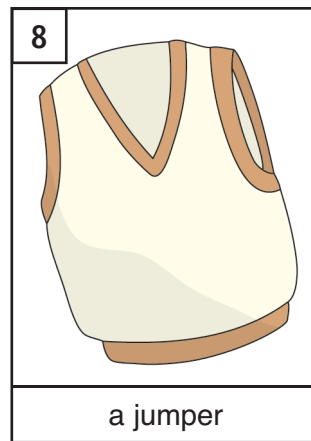
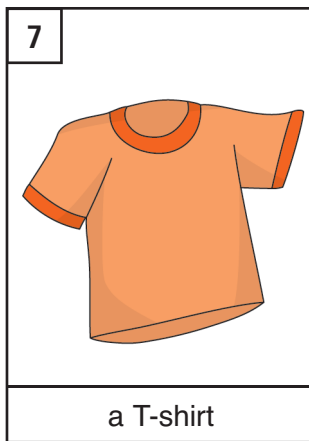
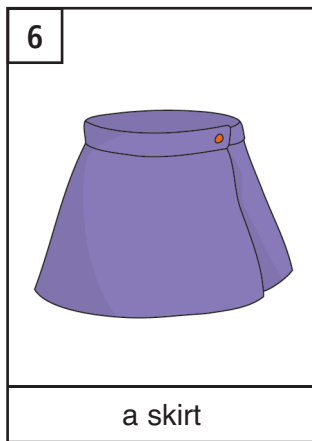
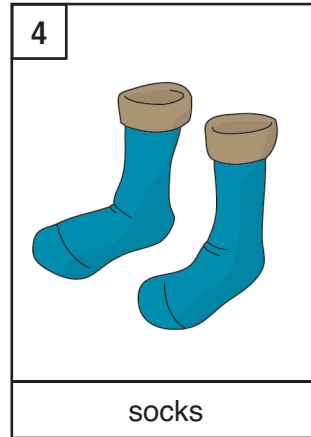
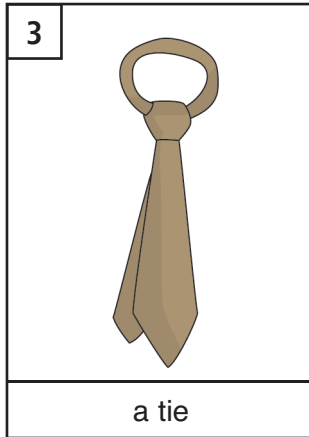
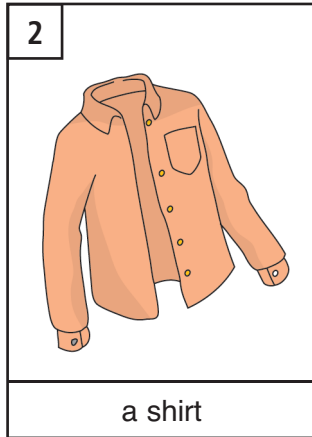
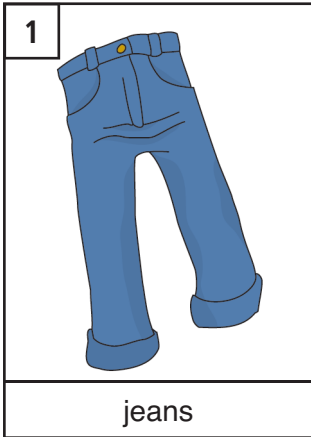

1

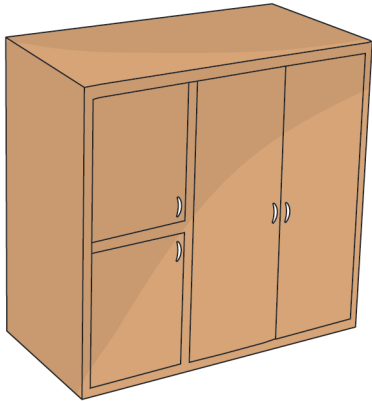

a wardrobe

2

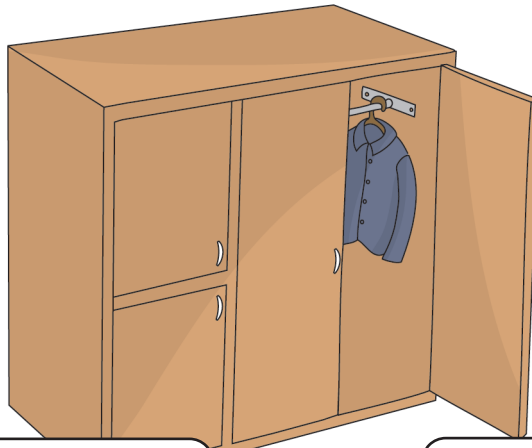

Where's your suit?

In the wardrobe.

3

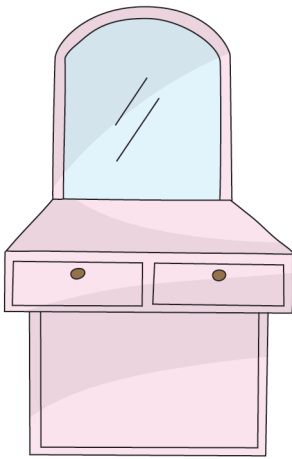

a dresser

4

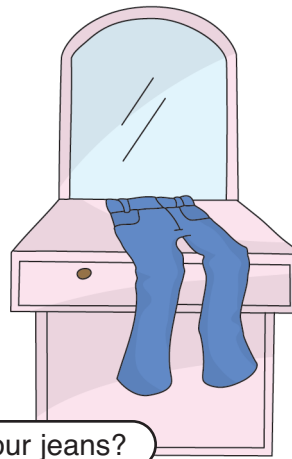

Where are your jeans?

On the dresser.

5



a chest of drawers

6

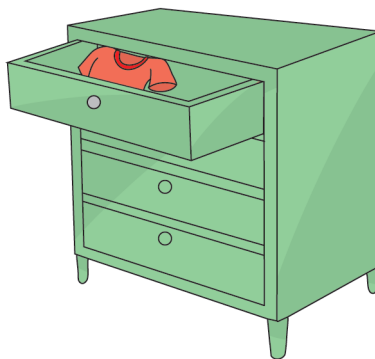

Where is your T-shirt?

In the top drawer.

7

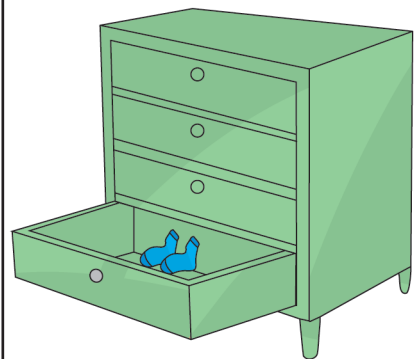

Where are your socks?

In the bottom drawer.

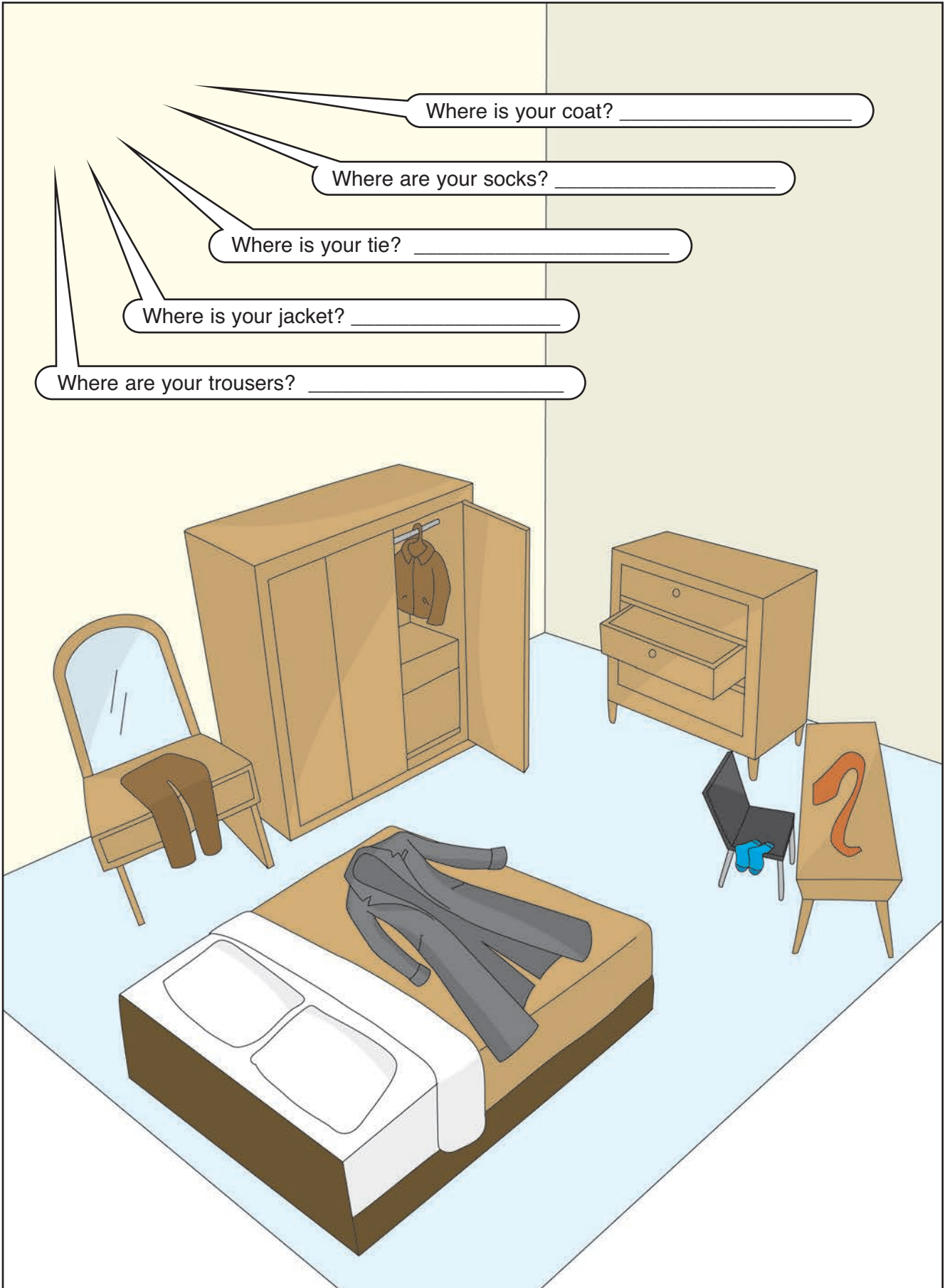



# The Bensons

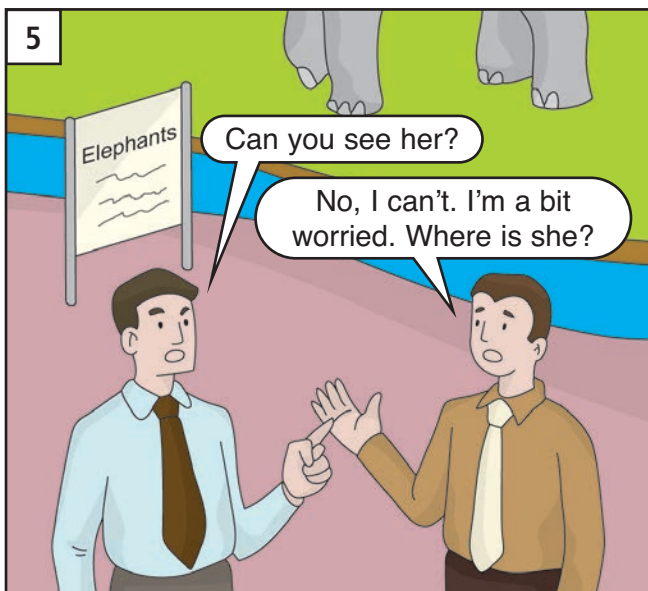
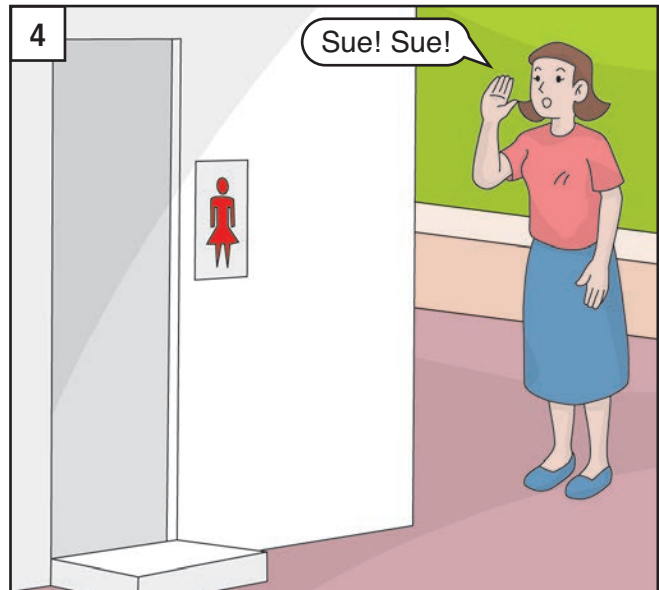
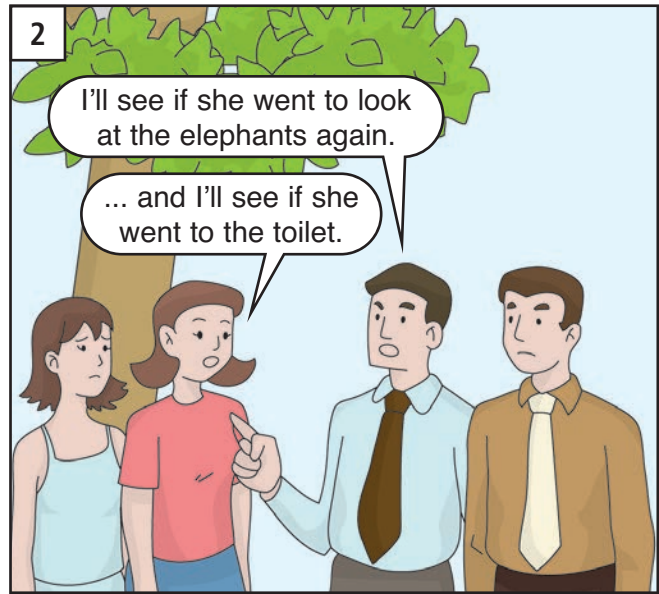

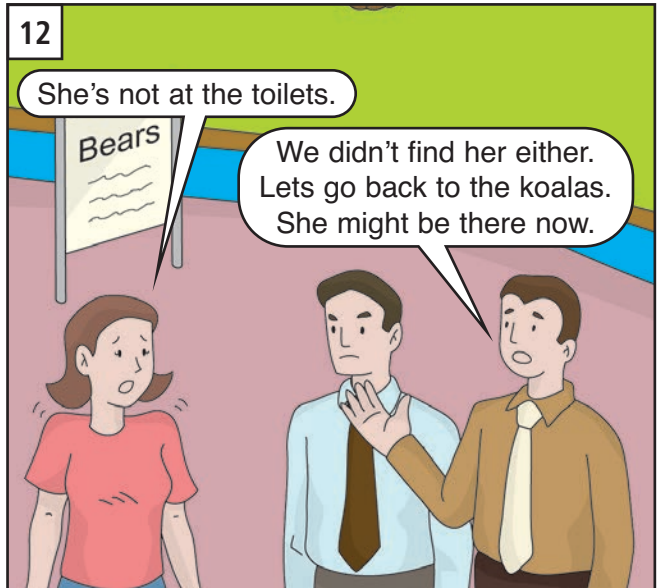
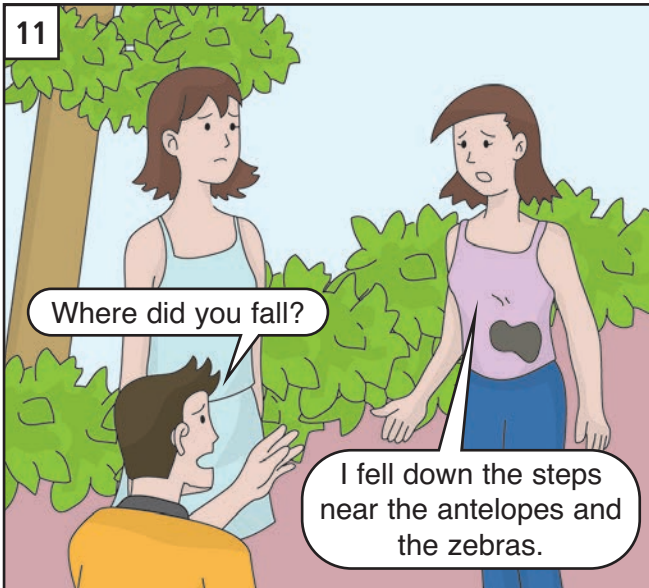
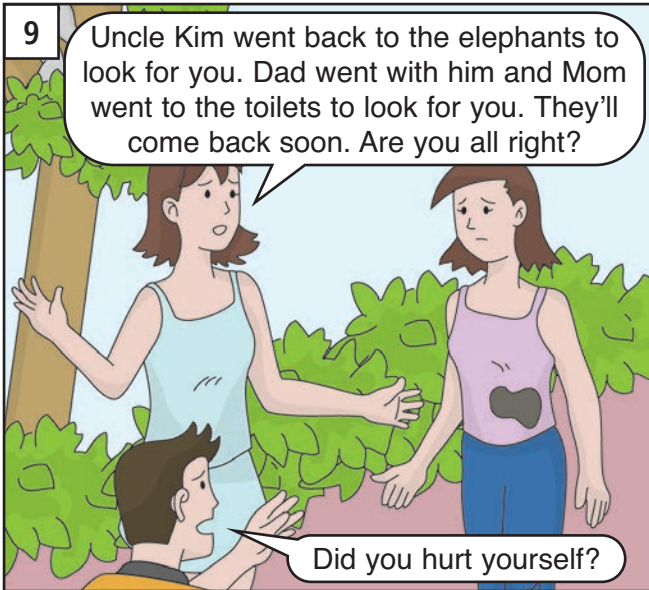

## UNIT 12: You'd better go to the dentist.

you'd better  
good idea

dentist  
x-ray

motorbike  
truck

happy  
unhappy  
comfortable  
uncomfortable  
done up  
undone  
safe  
unsafe  
pack  
unpack

room

have it ...ed

bench

move  
fix

hurry

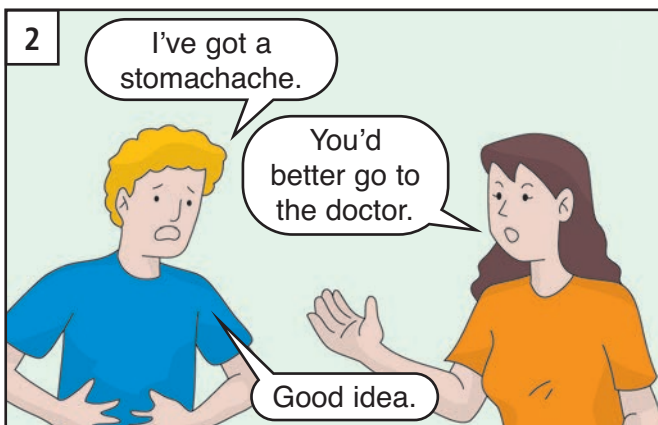
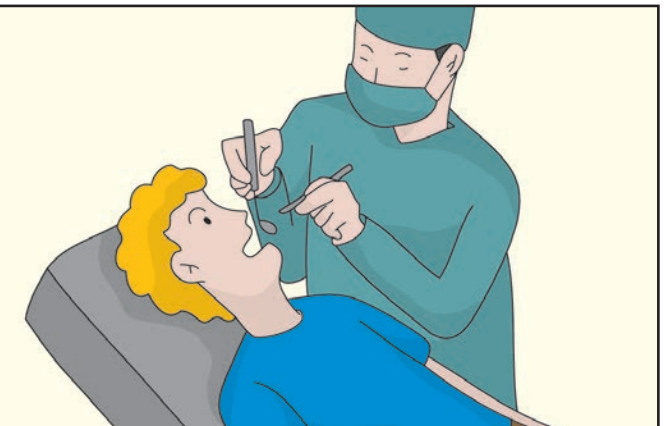
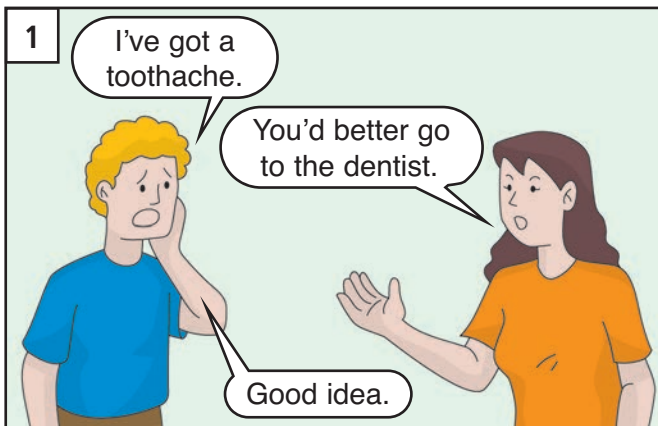

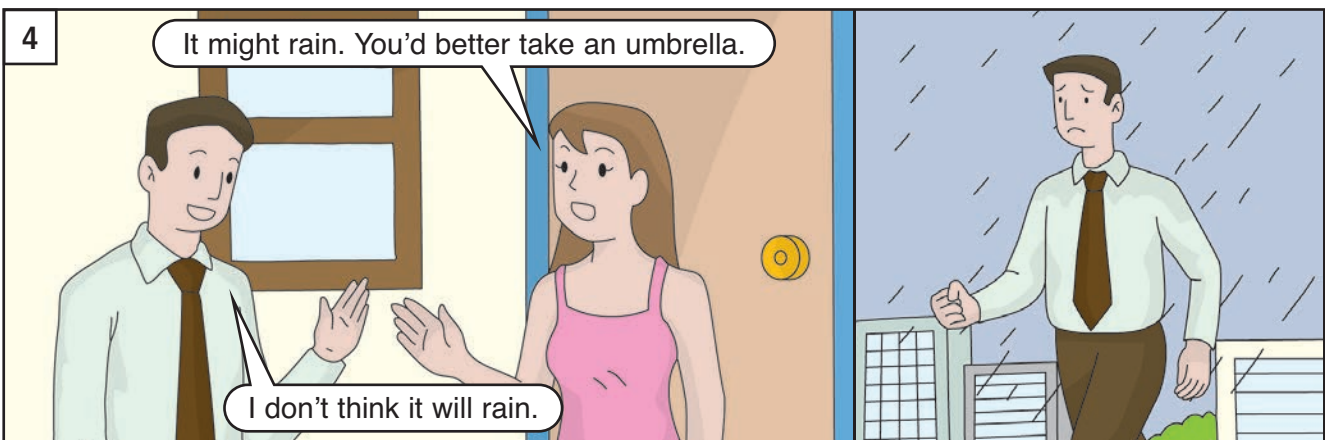
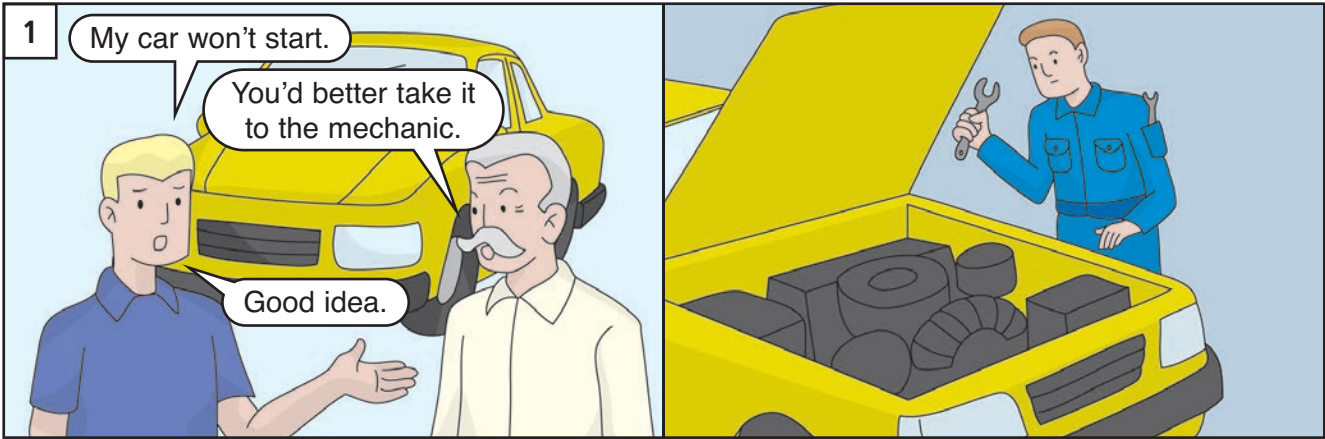

UNIT 12

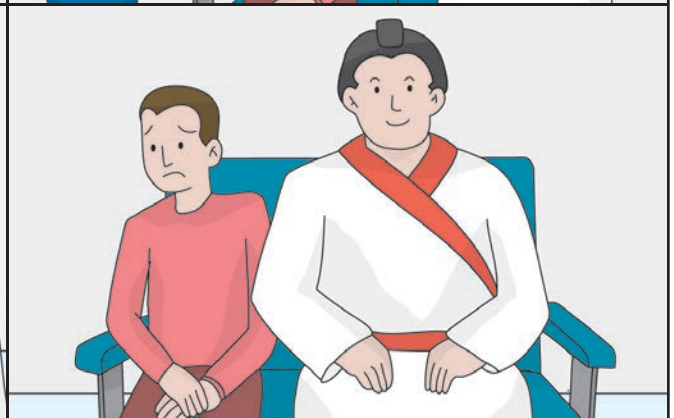
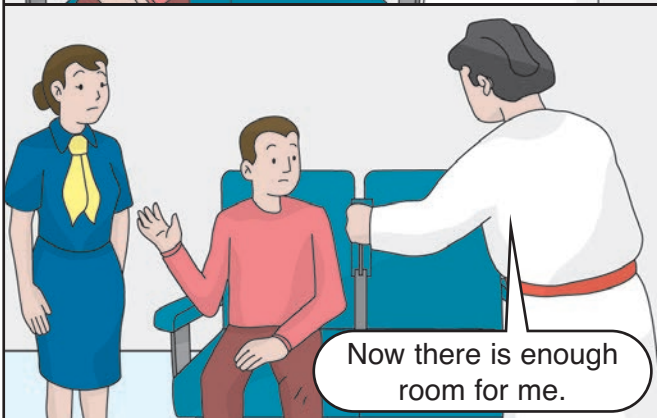
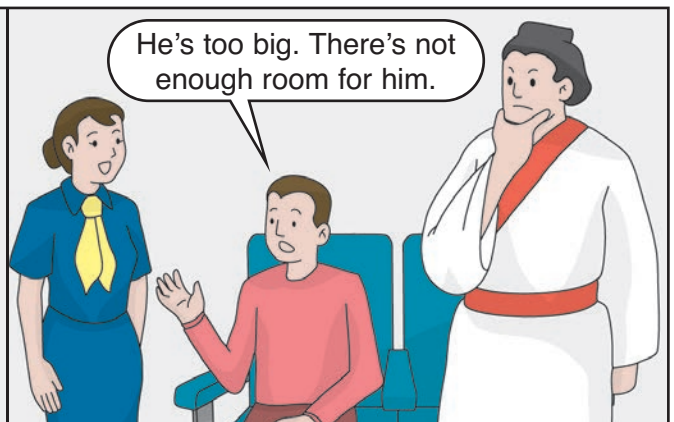
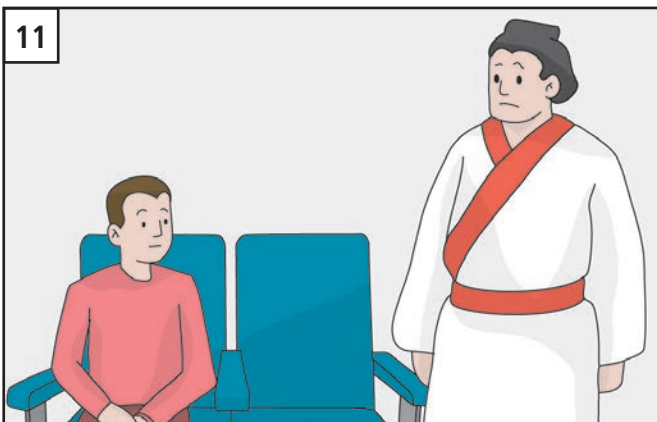
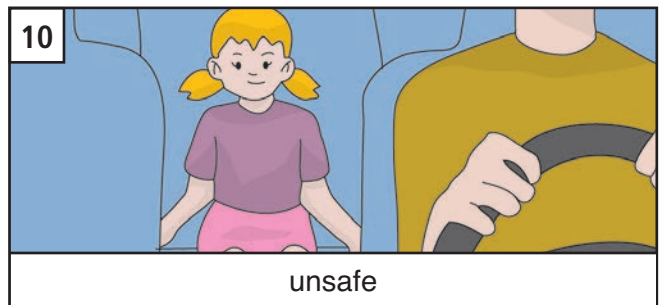
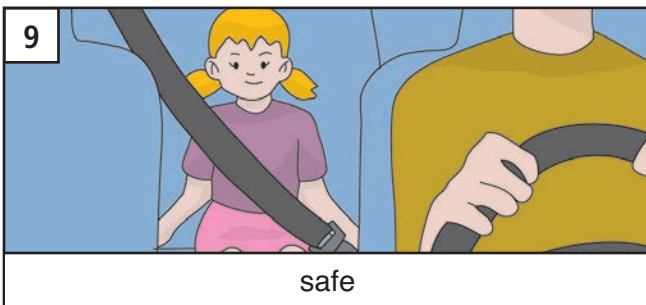
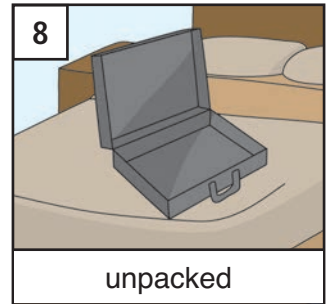
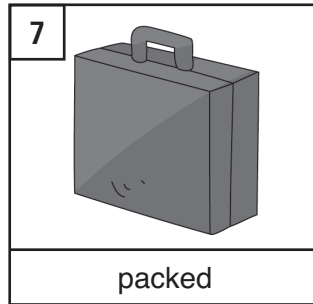
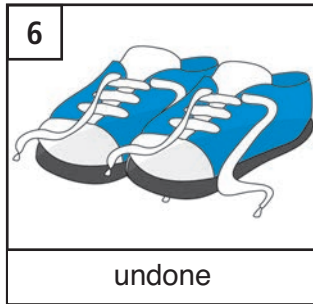
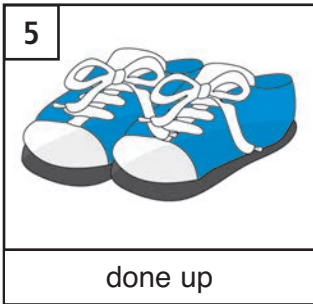
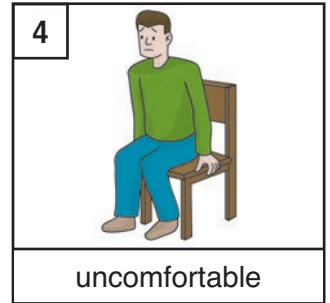
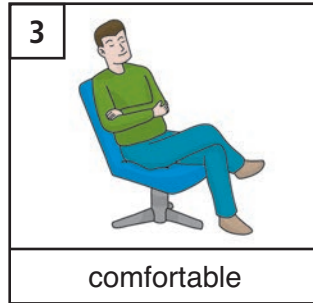
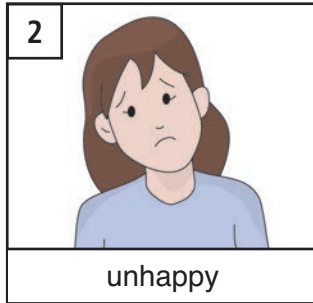
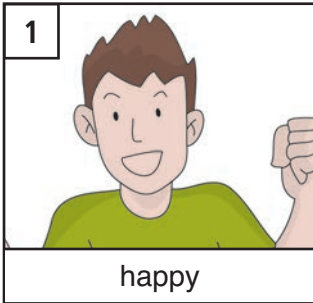

You'd better go to the dentist.

1

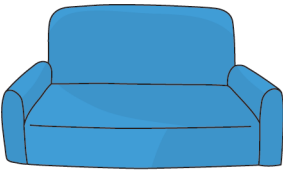

a sofa

2

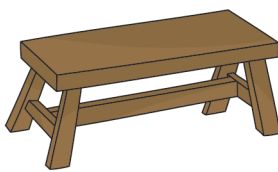

a bench

3



A sofa is more comfortable than a bench.

4

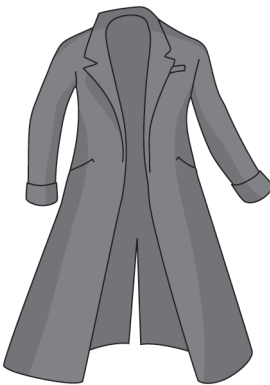

a coat

5

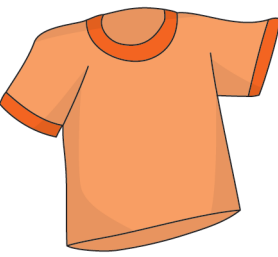

a T-shirt

6

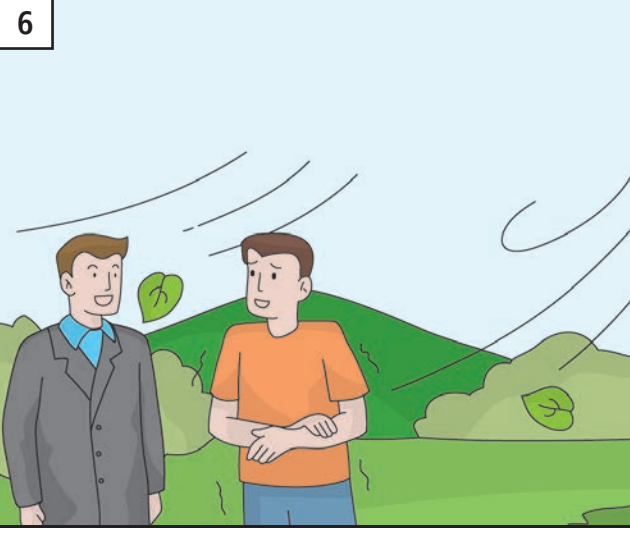

A coat is warmer than a T-shirt.

7

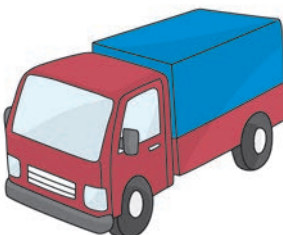

a truck

8

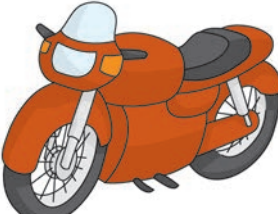

a motorbike

9

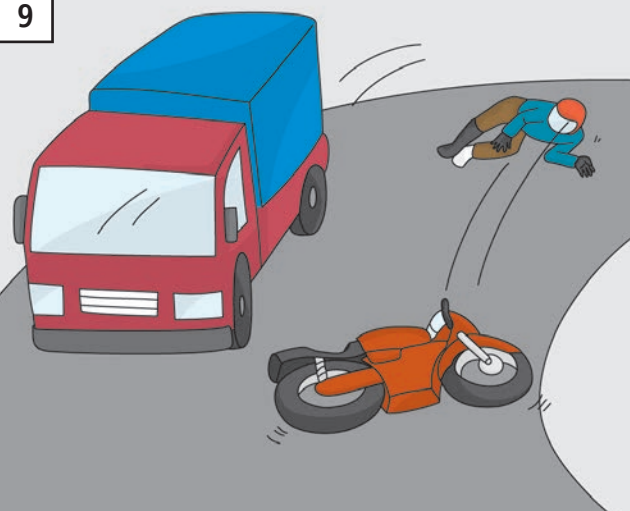

A truck is safer than a motorbike.

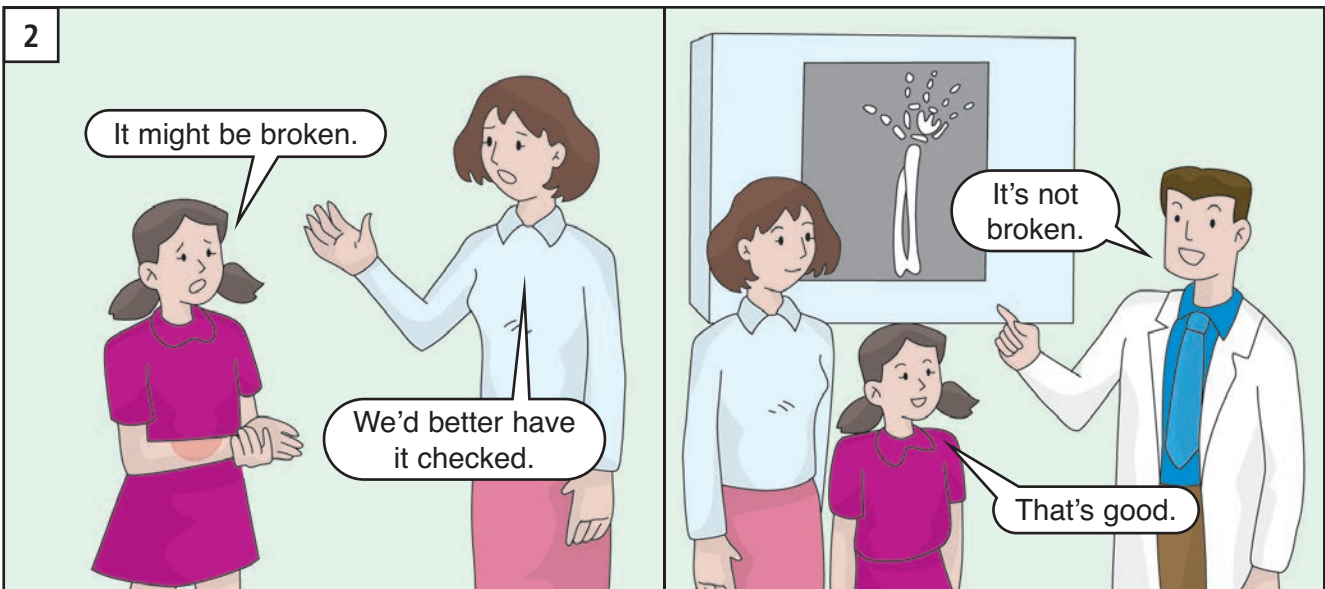
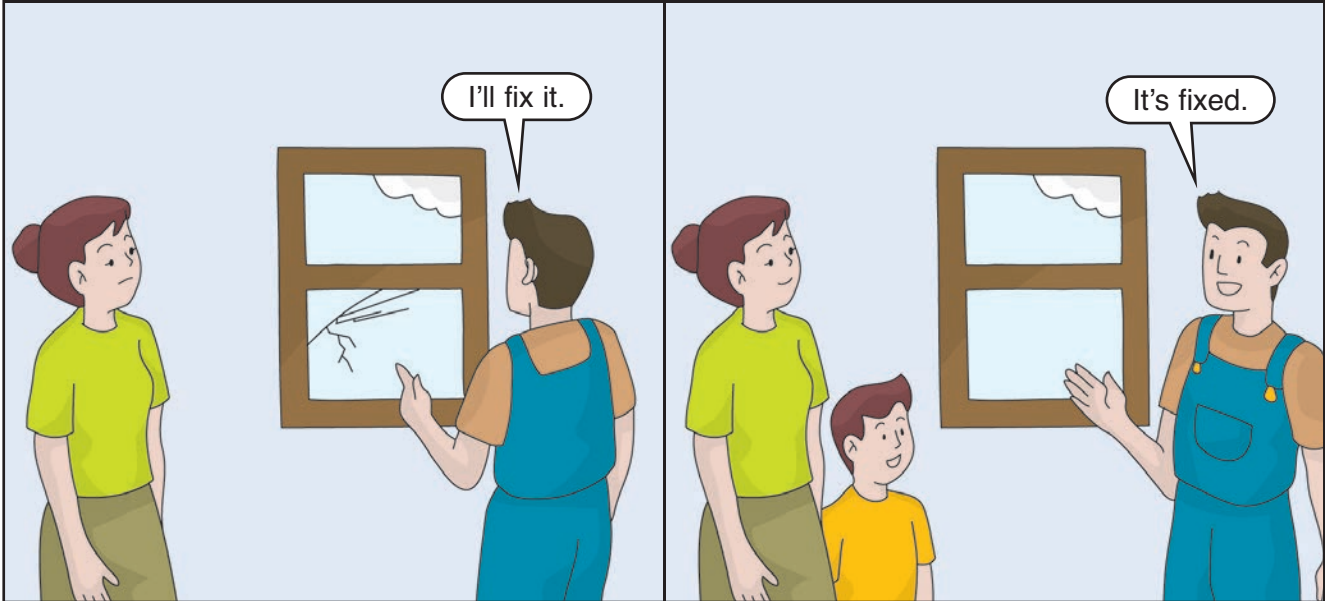
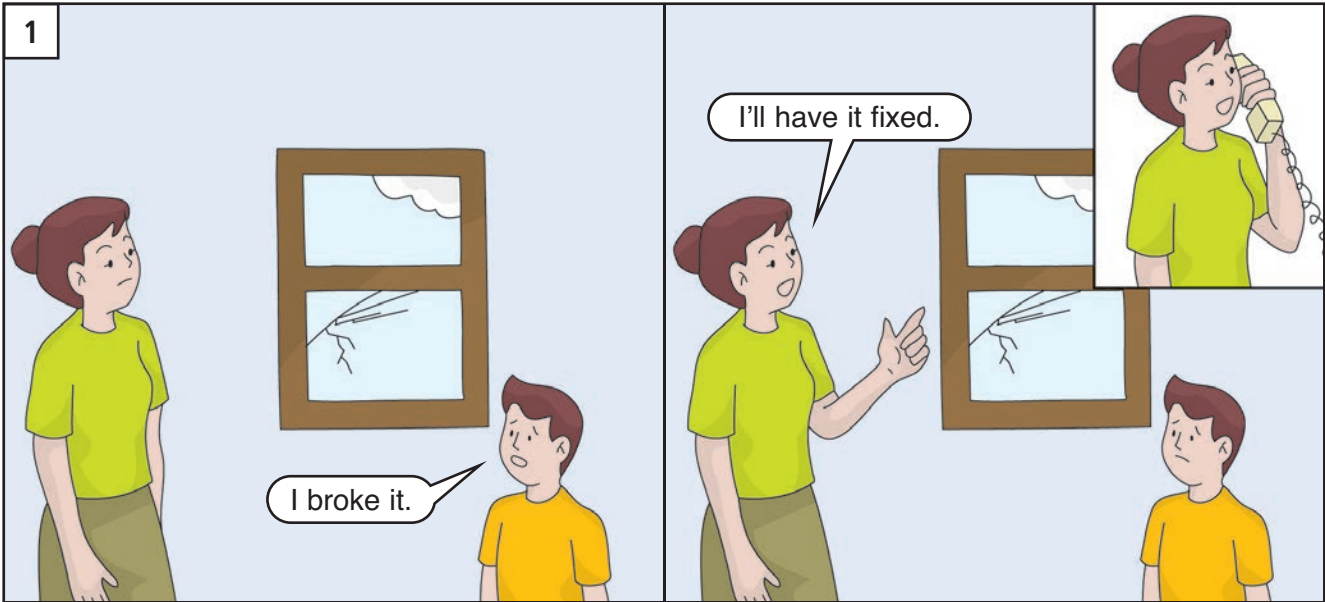

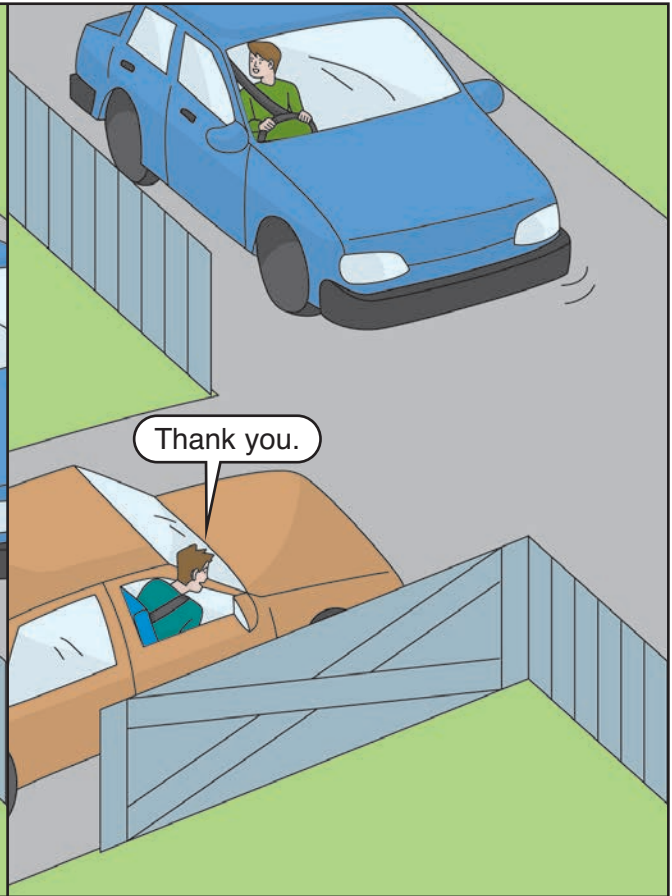
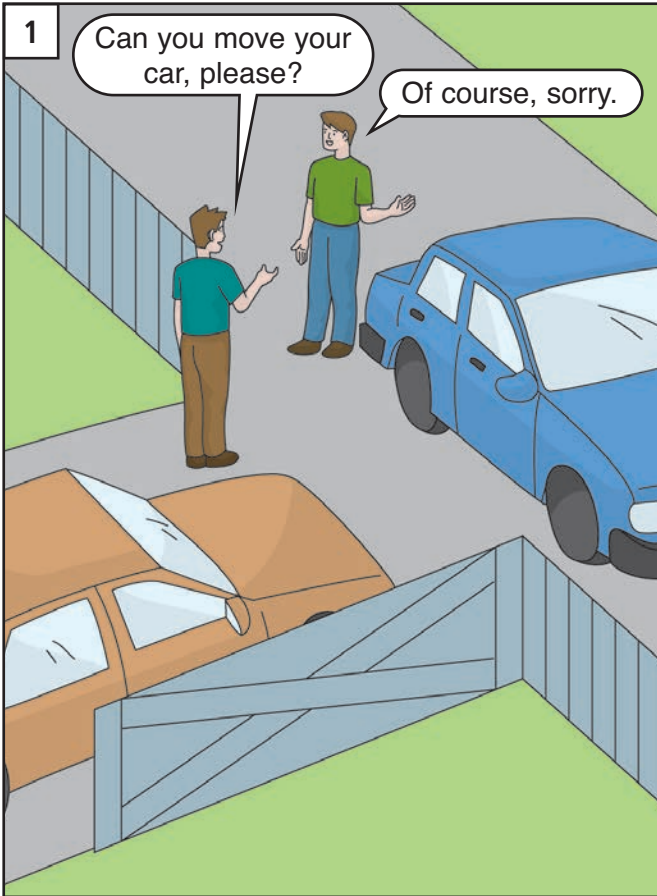

# The Bensons

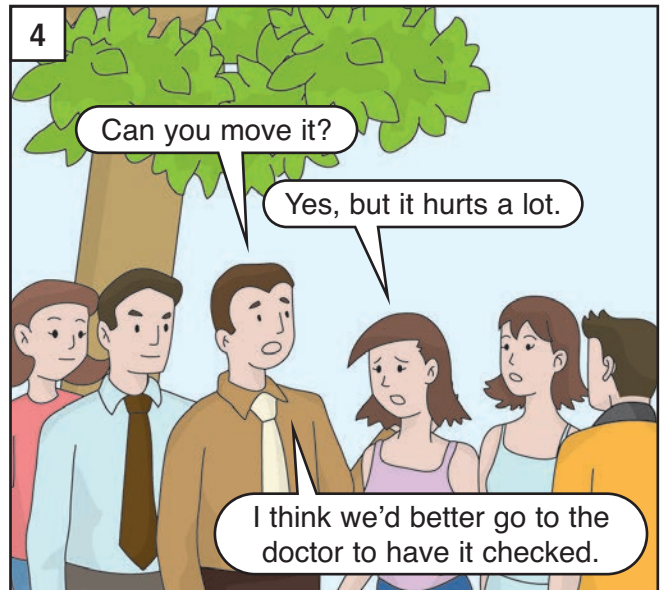
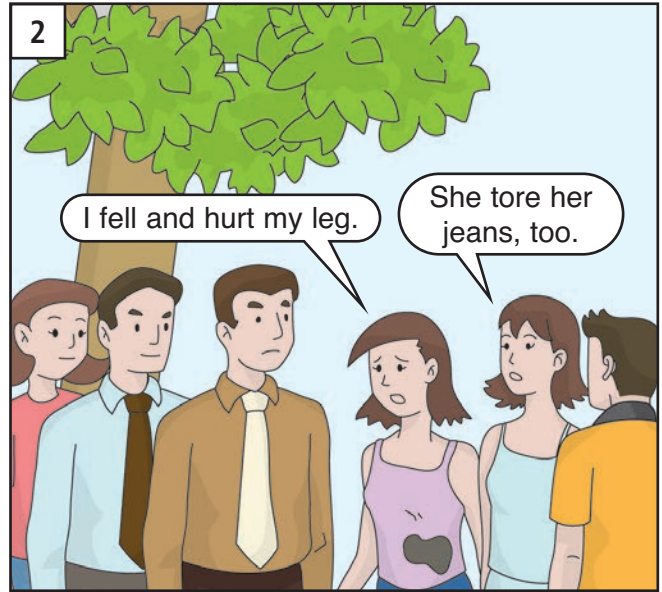
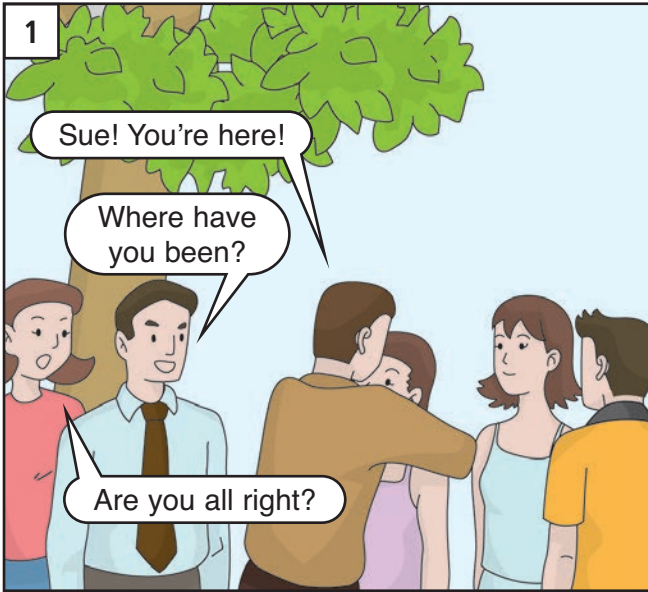

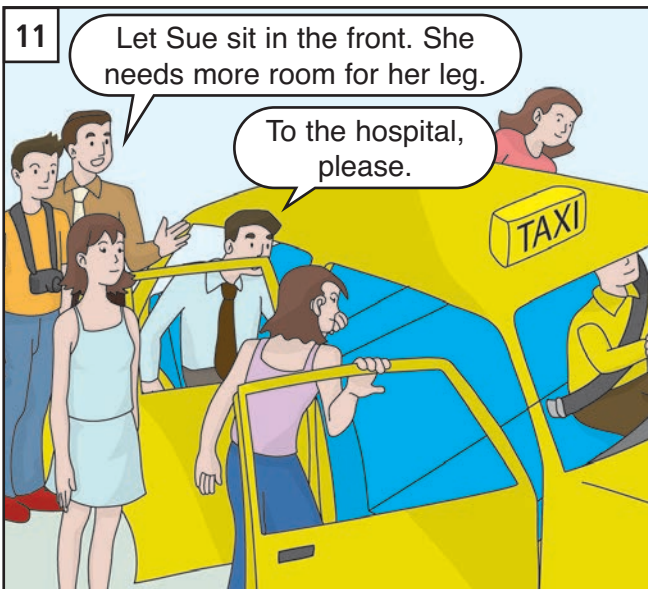

# UNIT 13: I was having breakfast when the phone rang.

tongue  
arm  
finger  
thumb  
eye  
nose  
mouth  
hair  
knee  
chest

show

careful  
careless  
caution  
danger

itchy  
swollen  
rash  
bite  
scratch  
cough  
bruised  
cut

band aid  
tablet  
prescription  
medicine  
bandage  
crutches  
rest  
stay in bed  
stop smoking  
exercise

take off  
put on

birthday

until  
soon

few

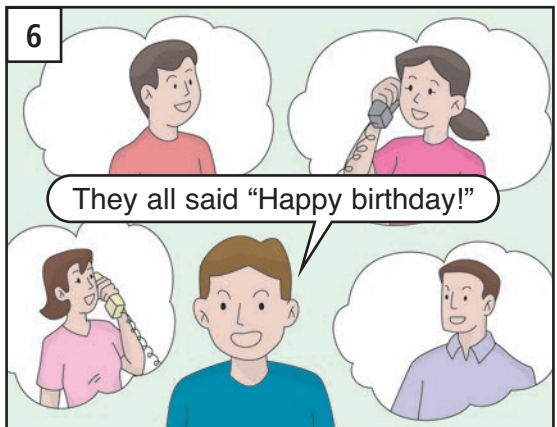
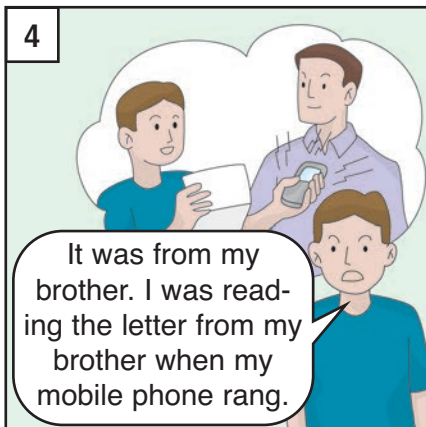
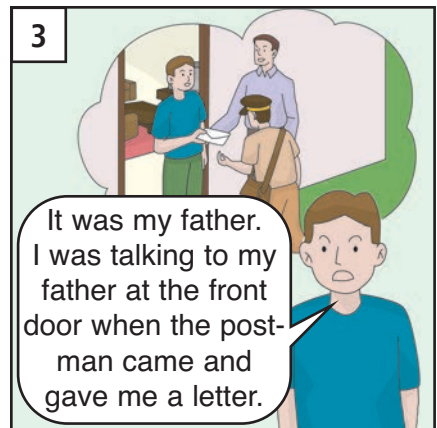
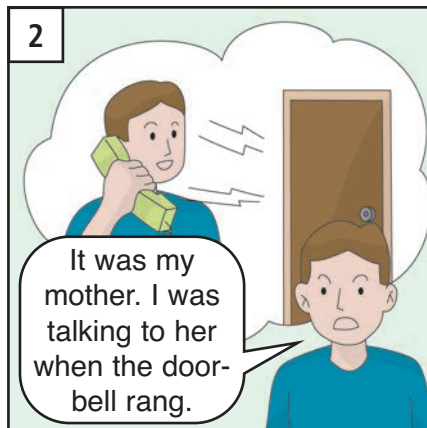
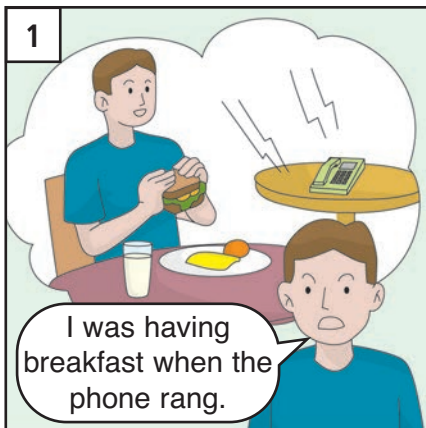

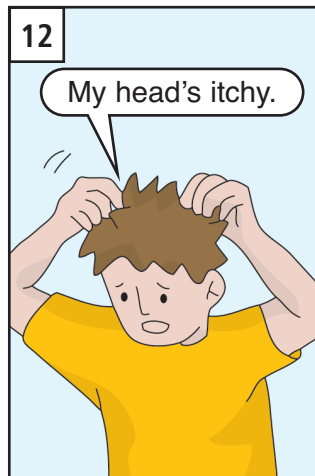
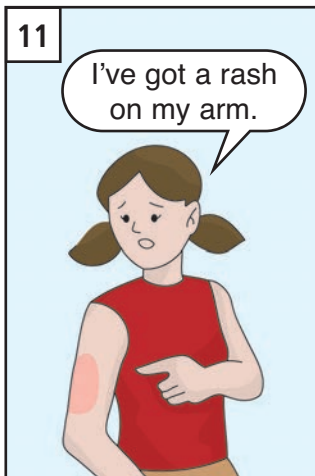
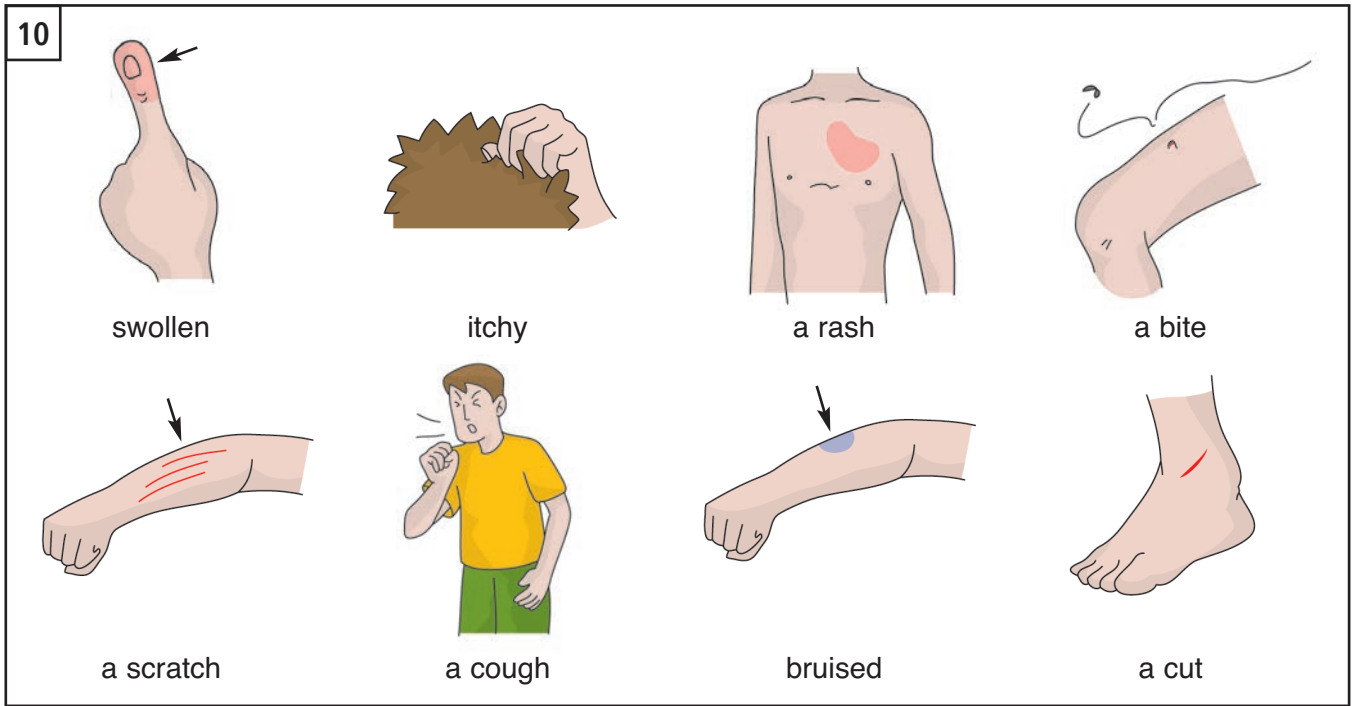
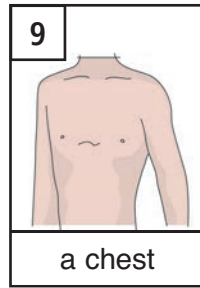
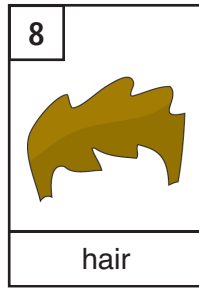
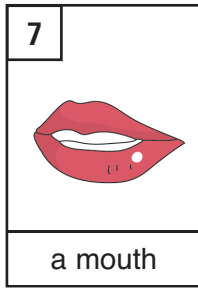
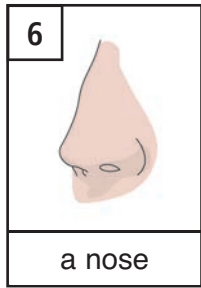
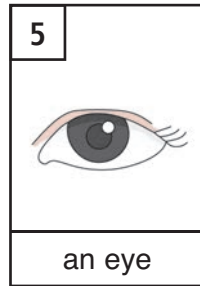
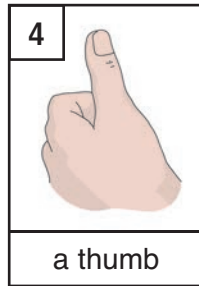
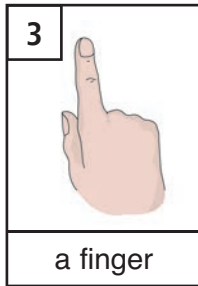
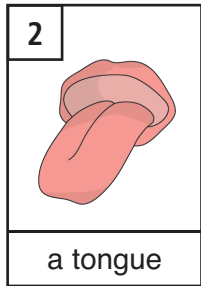
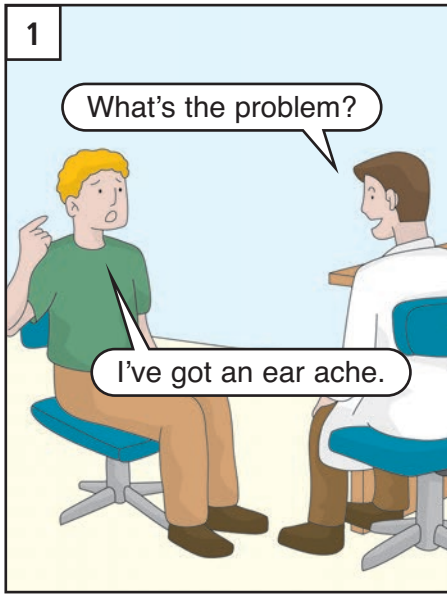

UNIT 13

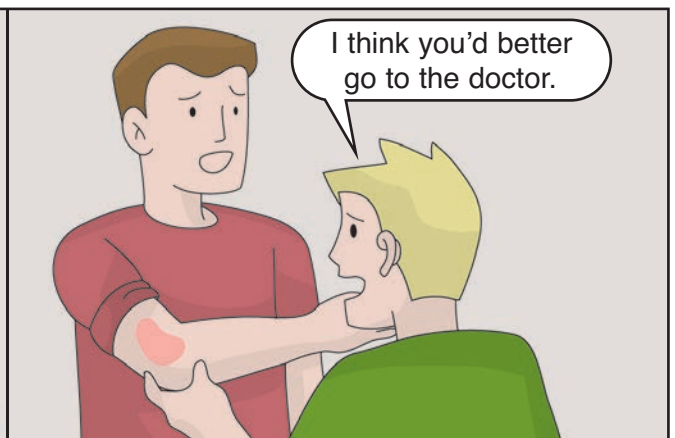
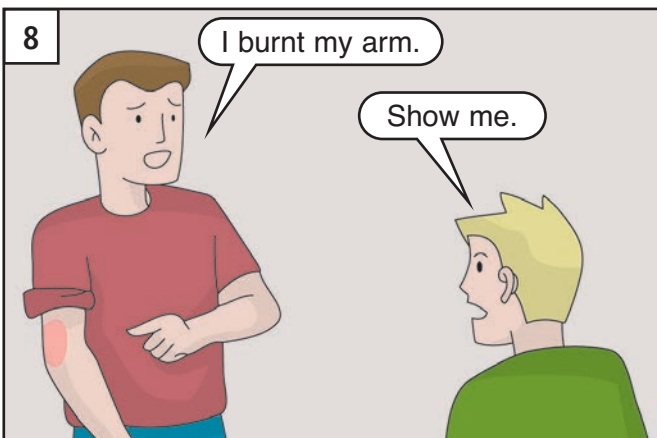
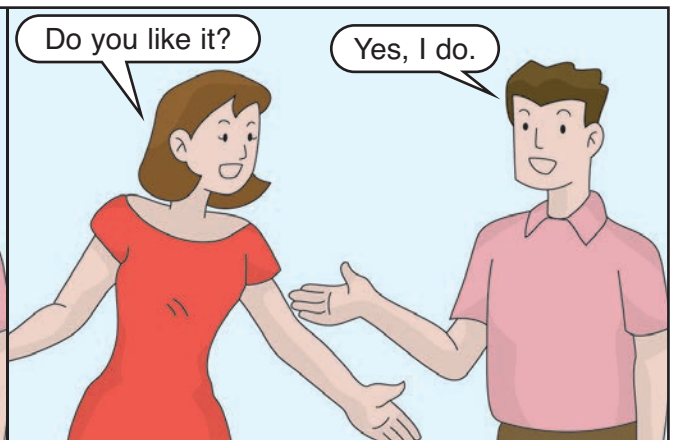
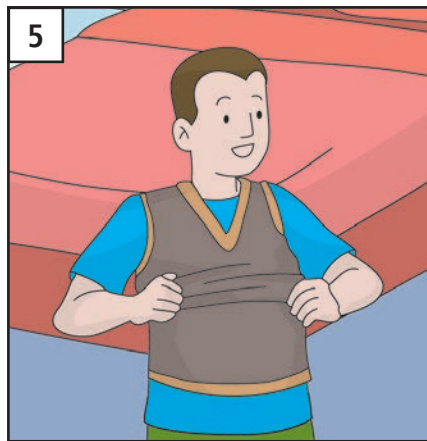
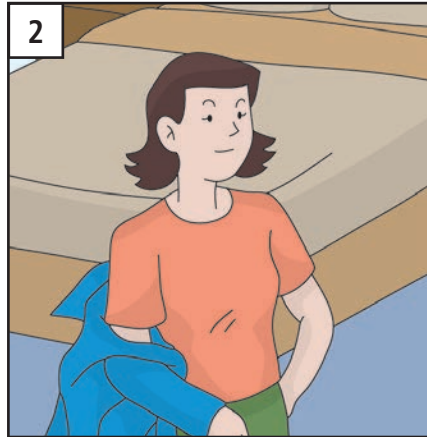

I was having breakfast when the phone rang.

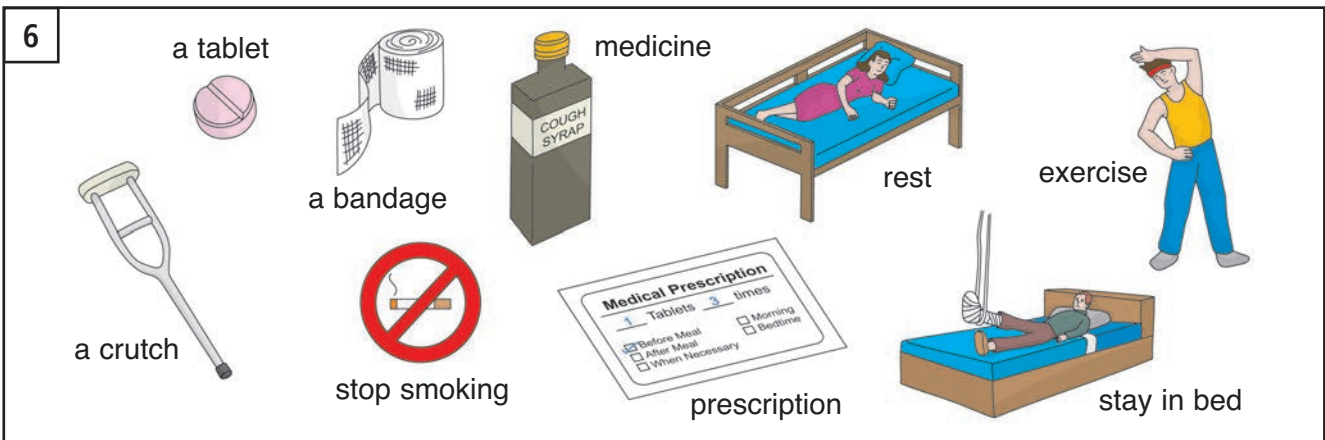
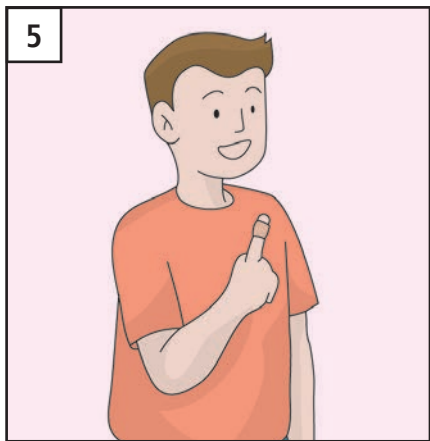
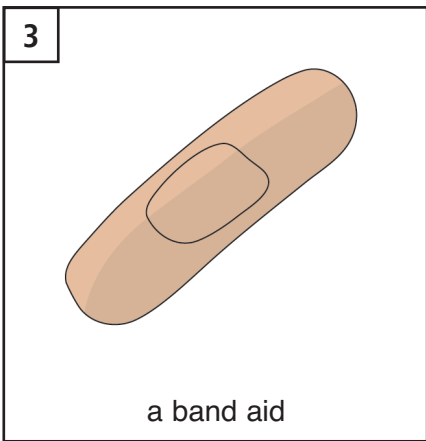
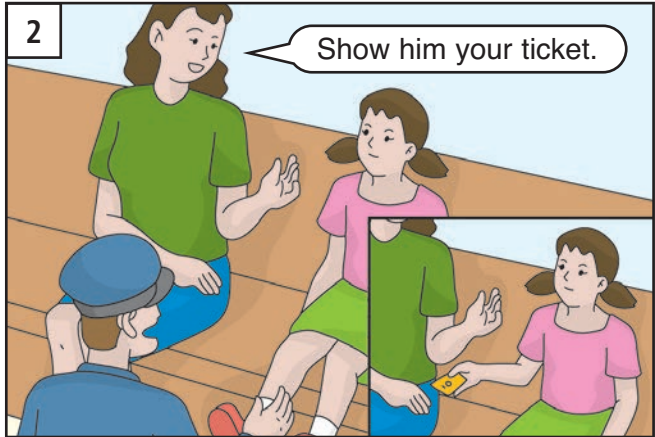
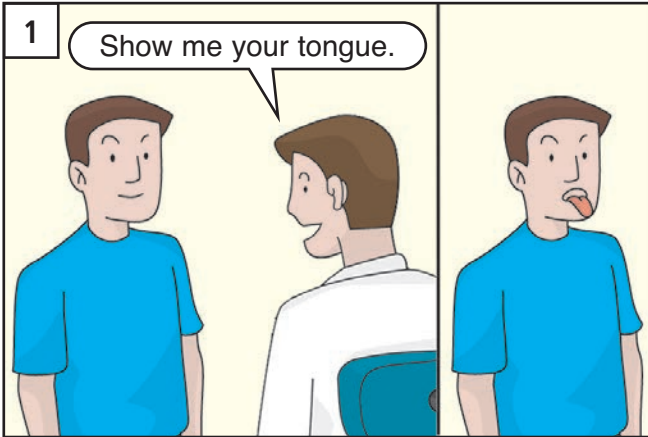

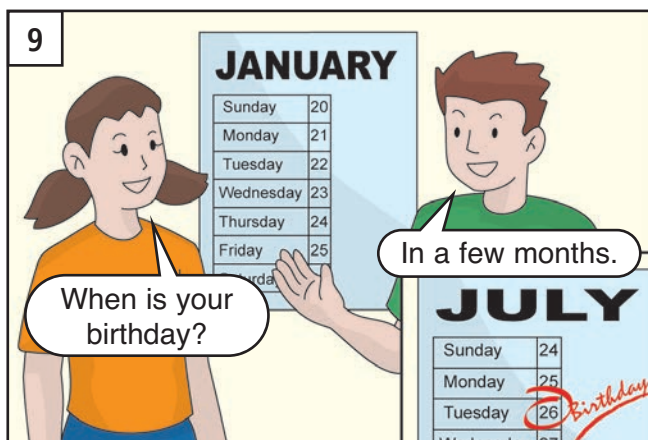
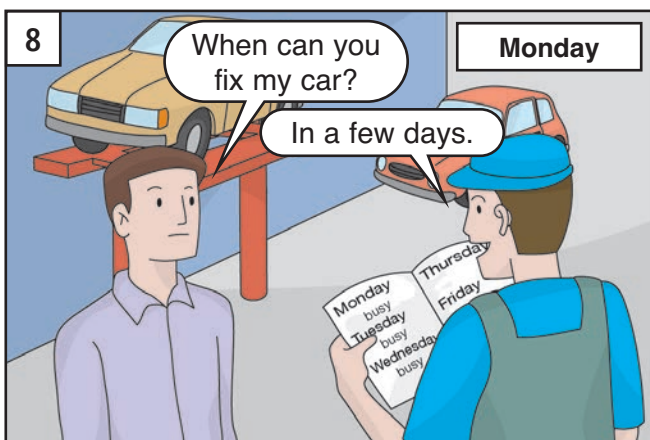
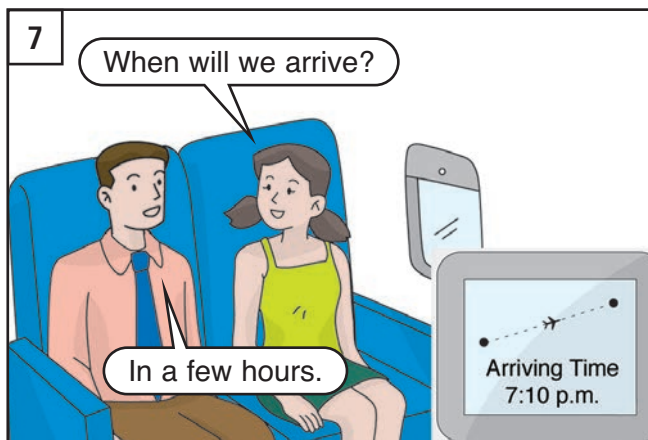

I was having breakfast when the phone rang.

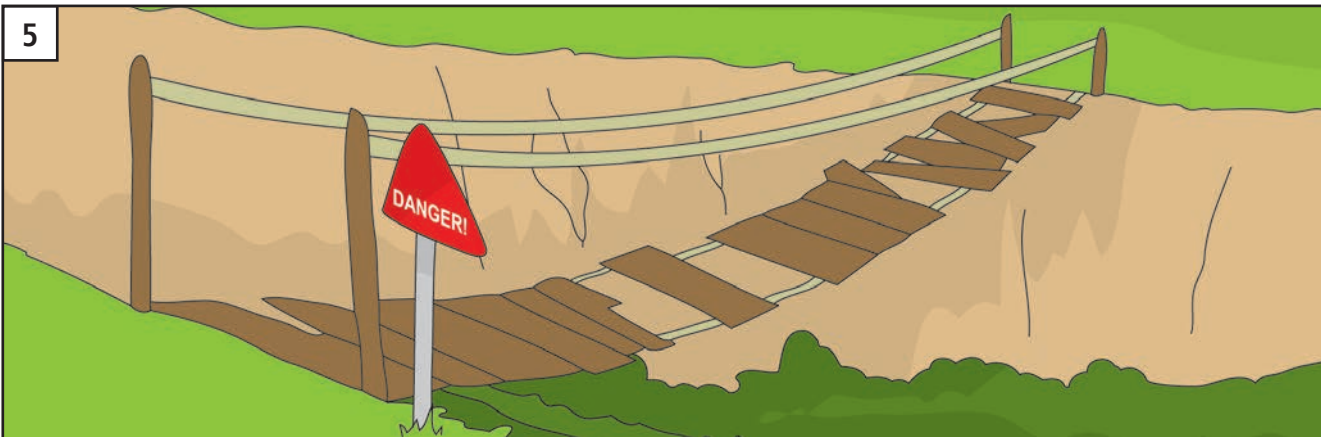
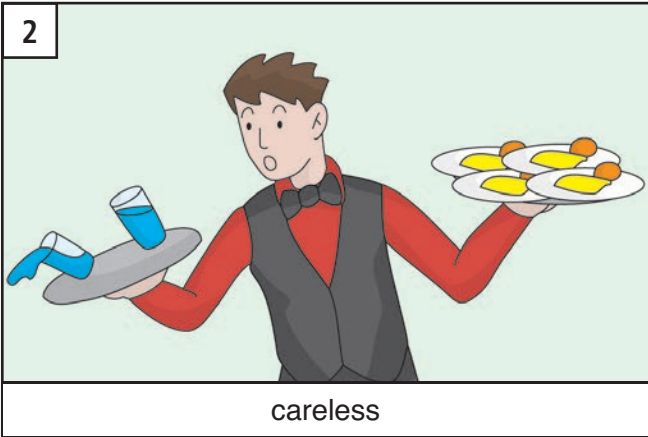
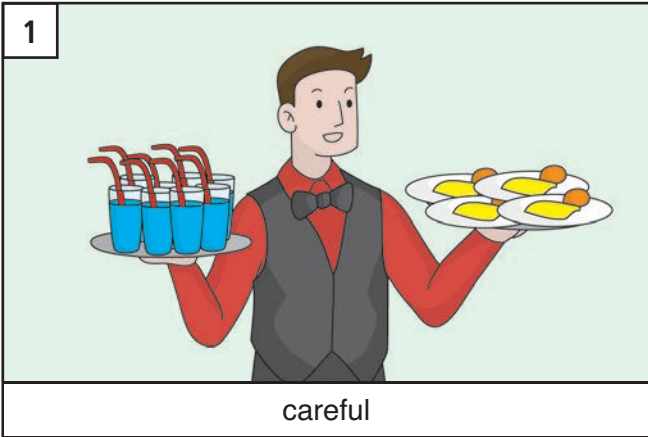

# The Bensons

1

How can I help you?

I fell and hurt my leg.

Sue has fallen at the zoo and hurt her leg. She is at the hospital.

2

Tell me how it happened.

I was at the zoo with my family when I fell.

3

I'd better have a look at it. Show me where it hurts.

Here.

4

Does it hurt when you walk?

Yes.

5

Does it hurt here?

Yes, it does.

6

It's swollen and bruised but I don't think it's broken. I'll put a bandage on it and you'd better rest for a few days.

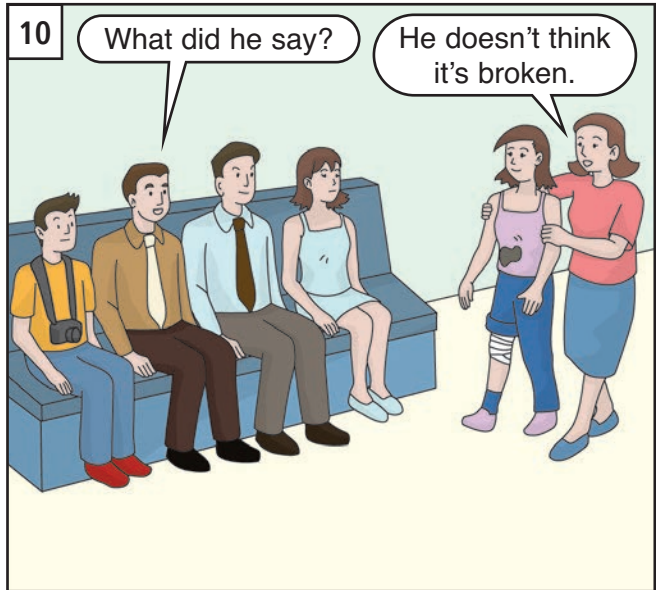
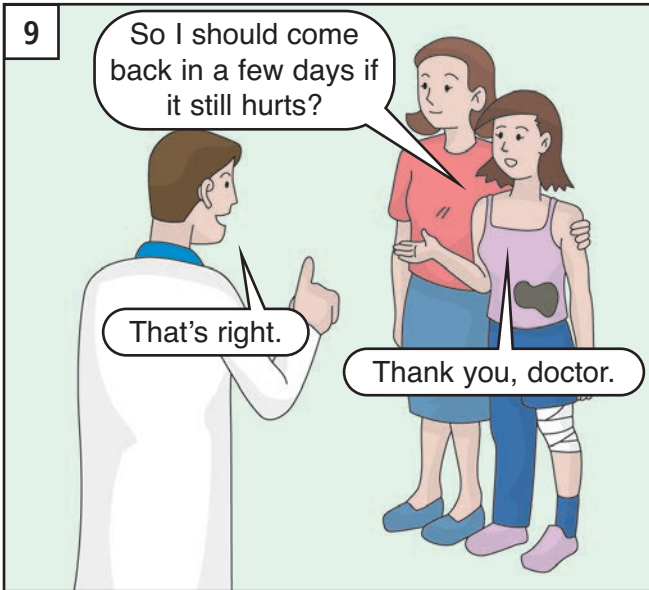
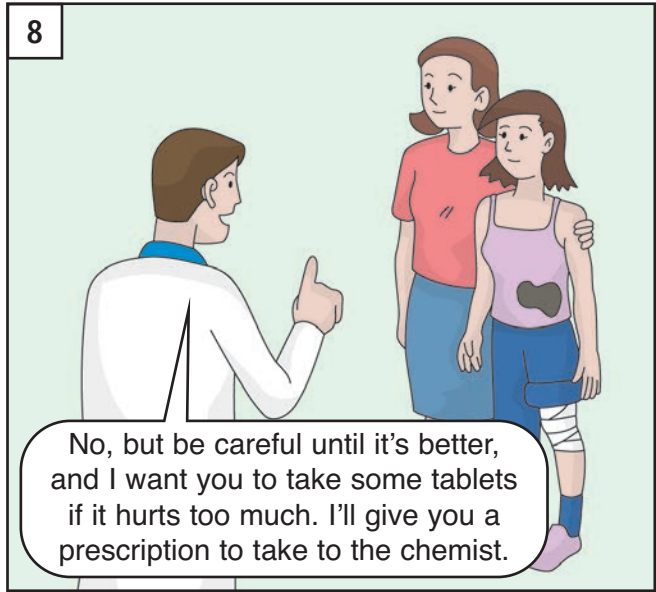
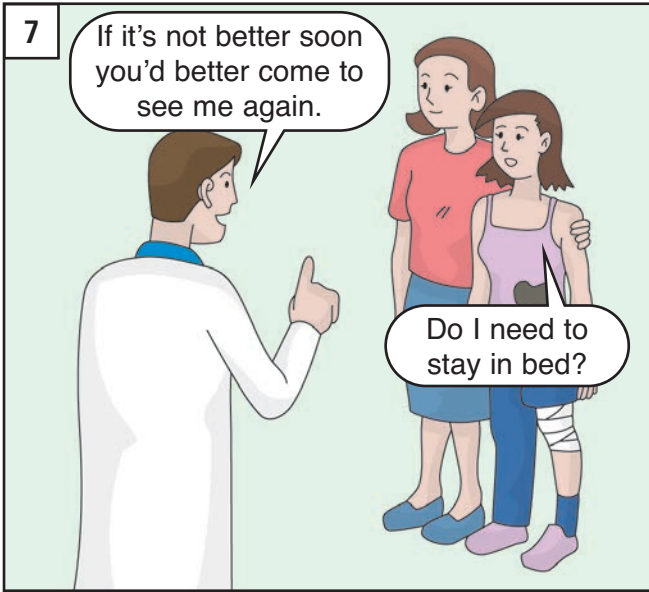

## UNIT 14: Do you have a receipt?

borrow	lend	distance	length	wheel
saw	drill	width	height	registration number
hammer	battery	high	wide	mirror
handbag	scarf	long	far	lights
plus	minus	centimeter	kilometer	damage
multiplied by	divided by	meter		driver's license
equals	percent	for sale	rent	panel beater
point		car rental firm		discount
limit		sign	signature	exchange
unlimited		form	fill out a form	refund
				cheque
				receipt
				insurance (company)
I'm afraid		include		windsurfer



Alan was sawing some wood when his saw broke. He went next door to borrow Jeff's saw. Jeff agreed and gave Alan the saw. Alan finished sawing the wood and brought the saw back to Jeff.

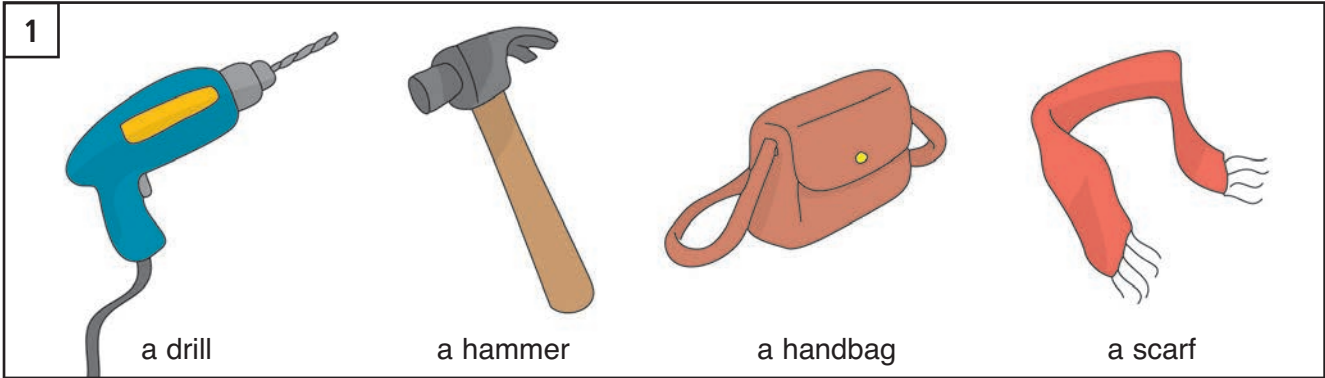

UNIT 14

1	+	-	X	÷	=	%	.
	plus	minus	multiplied by	divided by	equals	percent	point

2

Eight plus four equals twelve.

$$8 + 4 = 12$$

3

Eight minus four equals four.

$$8 - 4 = 4$$

4

Eight multiplied by four equals thirty-two.

$$8 \times 4 = 32$$

5

Eight divided by four equals two.

$$8 \div 4 = 2$$

6

Fifty percent of eight equals four.

$$50\% \text{ of } 8 = 4$$

7

Twenty five percent of ten equals two point five.

$$25\% \text{ of } 10 = 2.5$$

8

a battery

9

Total price \$8

10

Total price \$9

11

I'll take these.

That's \$100, please.

10% Discount Today

No. I'm sorry. I forgot.

Does that include 10% discount?

10% Discount Today

So it's \$100 minus \$10. The total price is \$90.

Thank you.

10% Discount Today

Do you have a receipt?

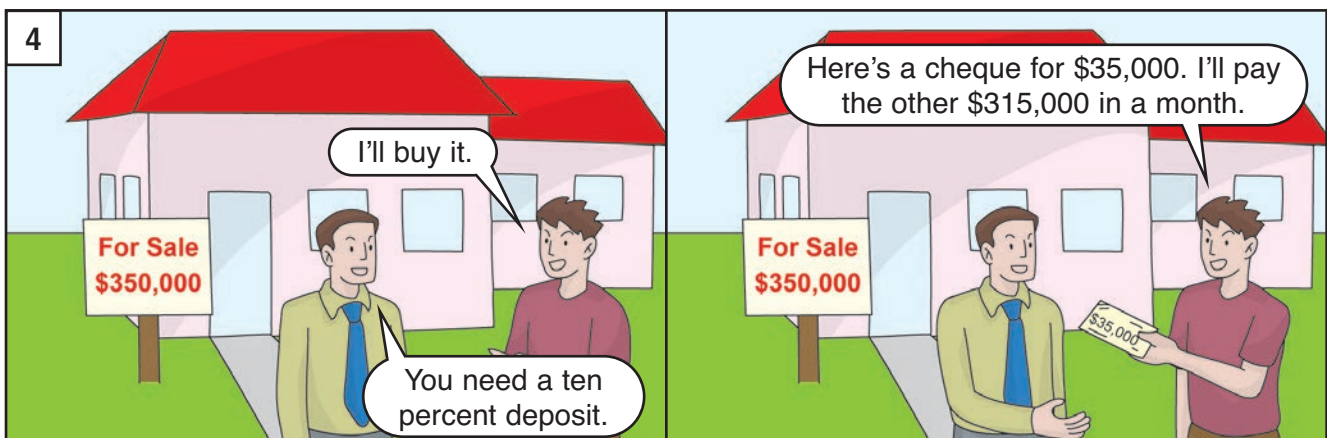
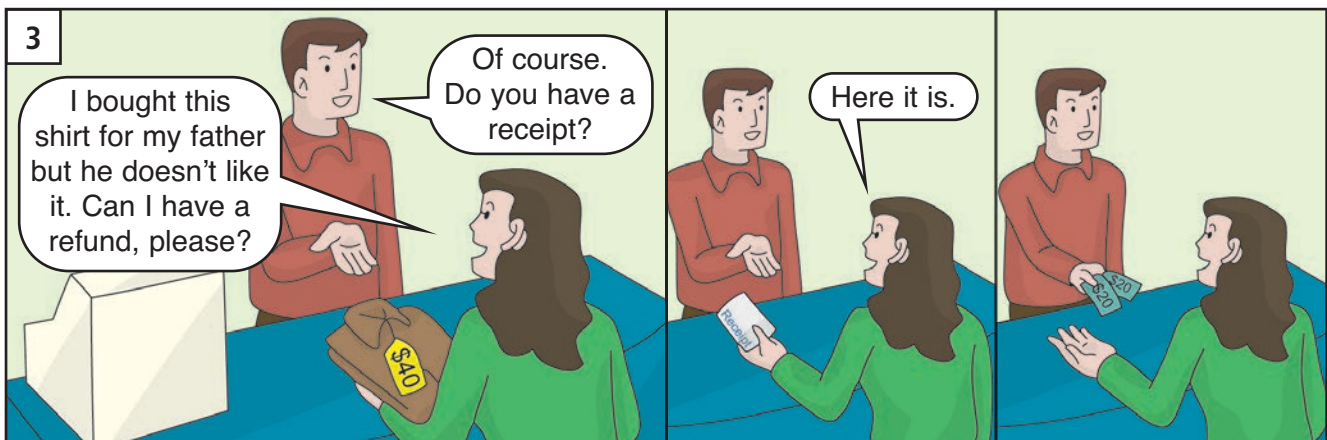
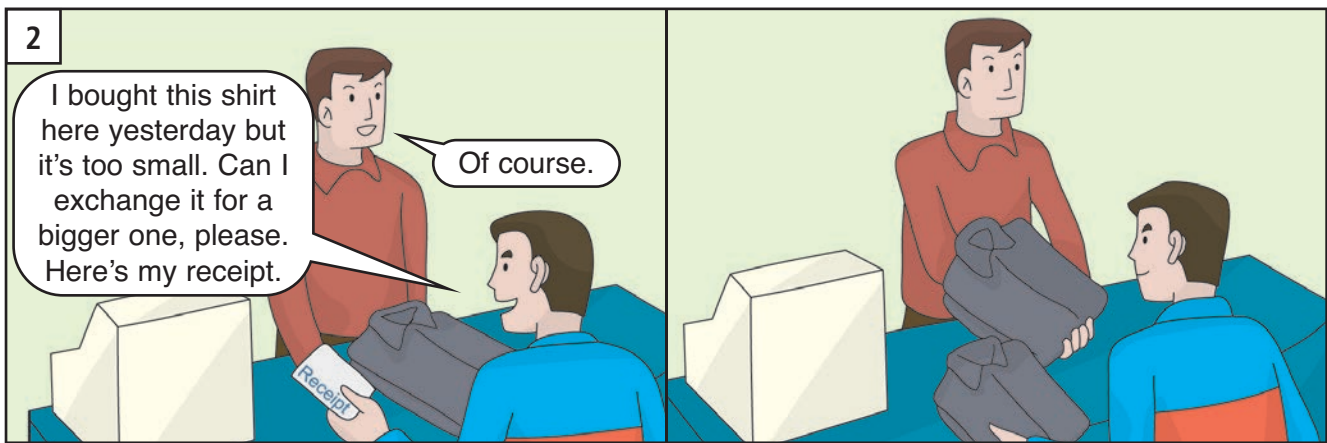

UNIT 14

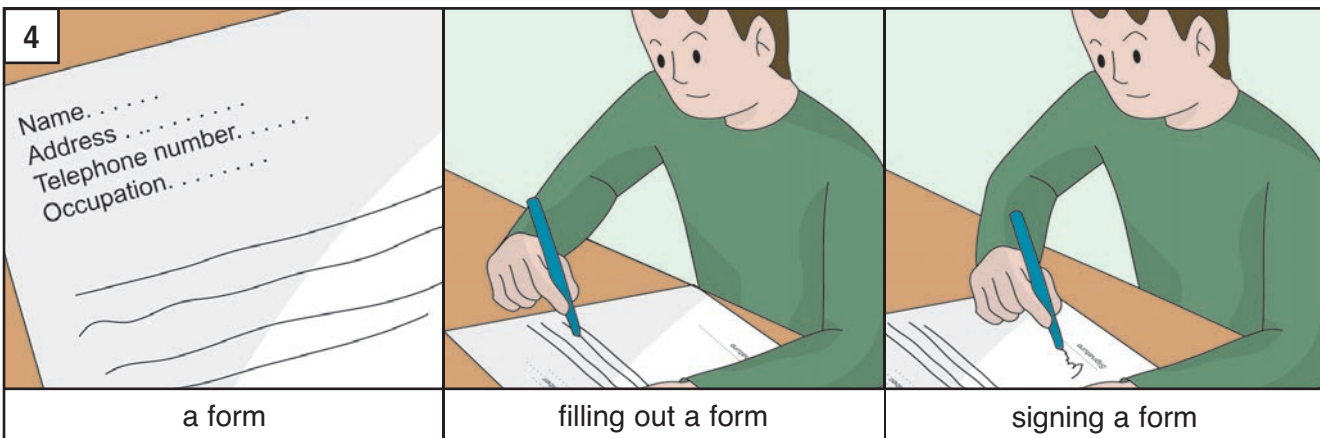
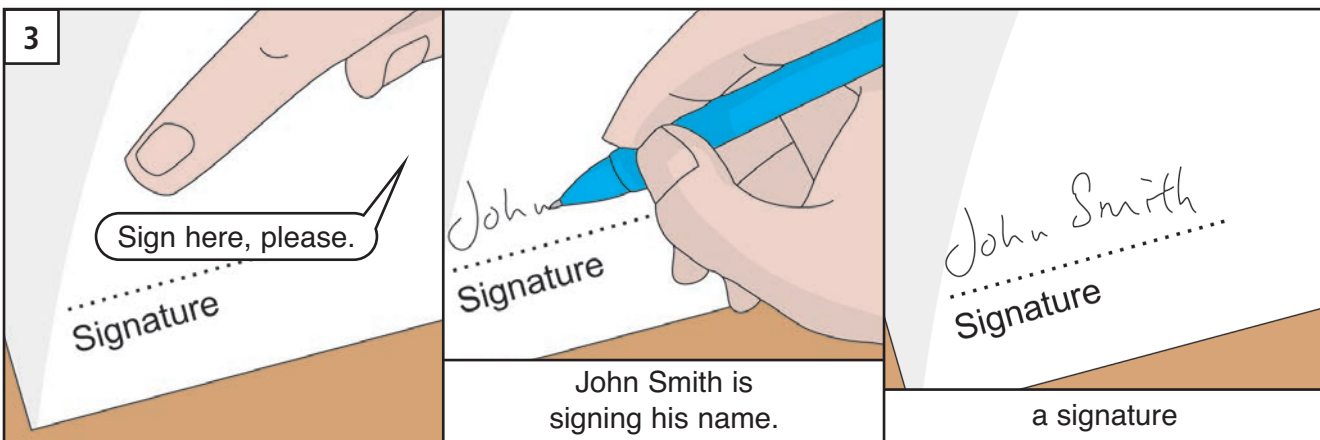
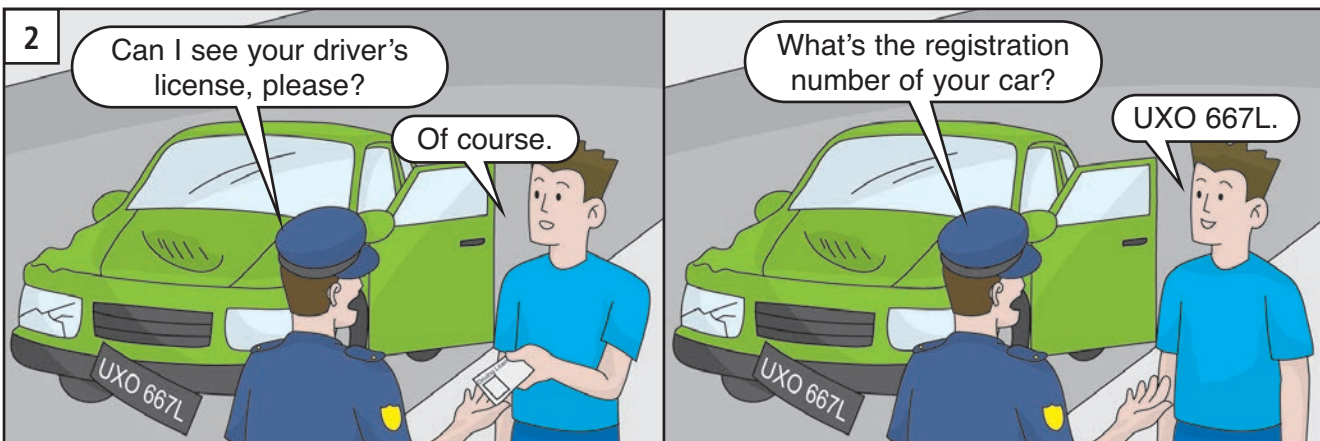
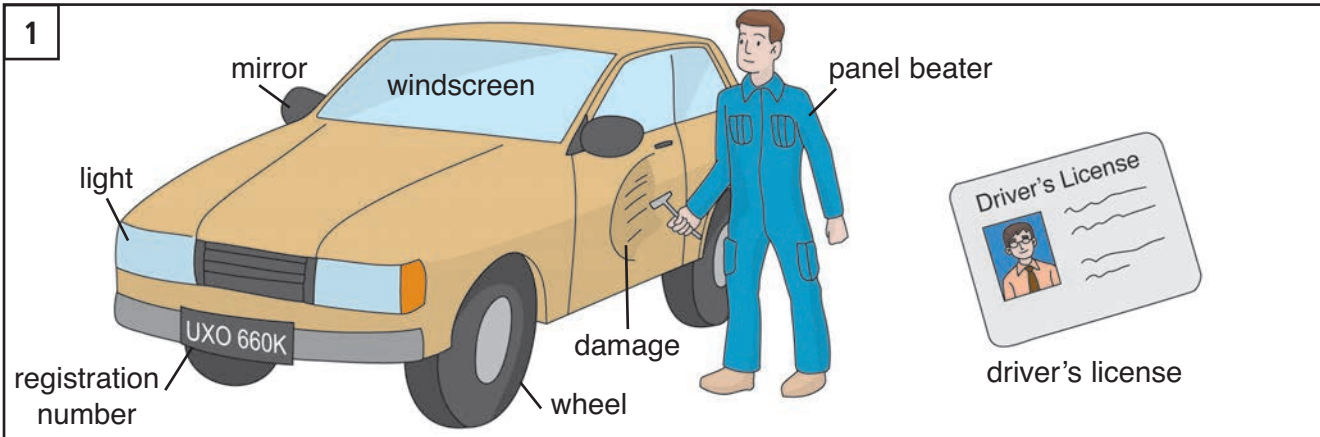

Do you have a receipt?

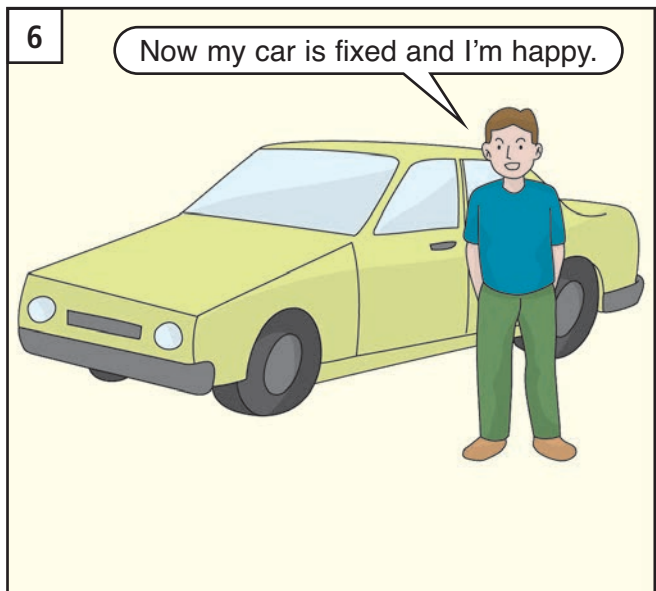
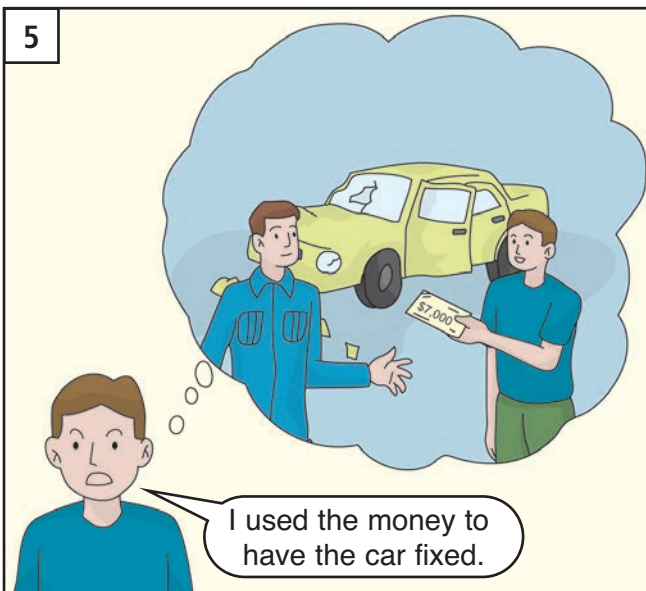
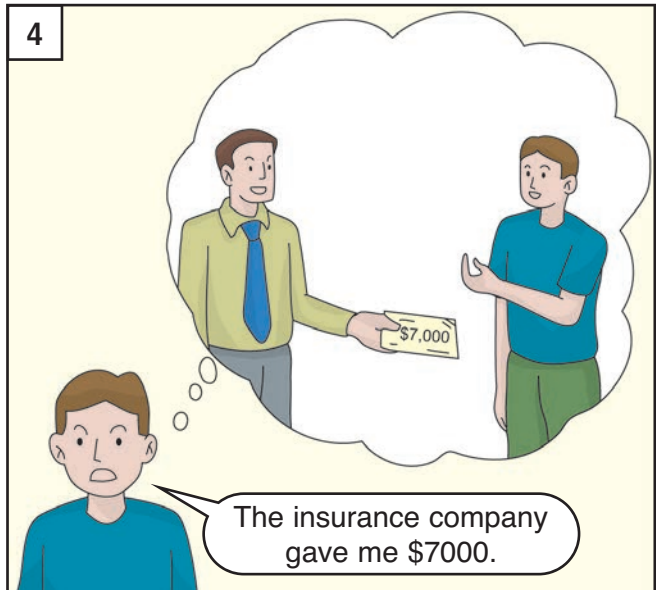
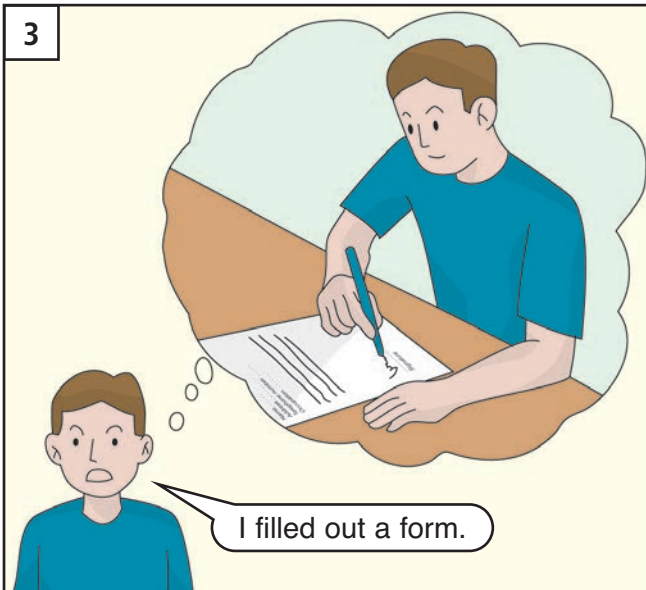
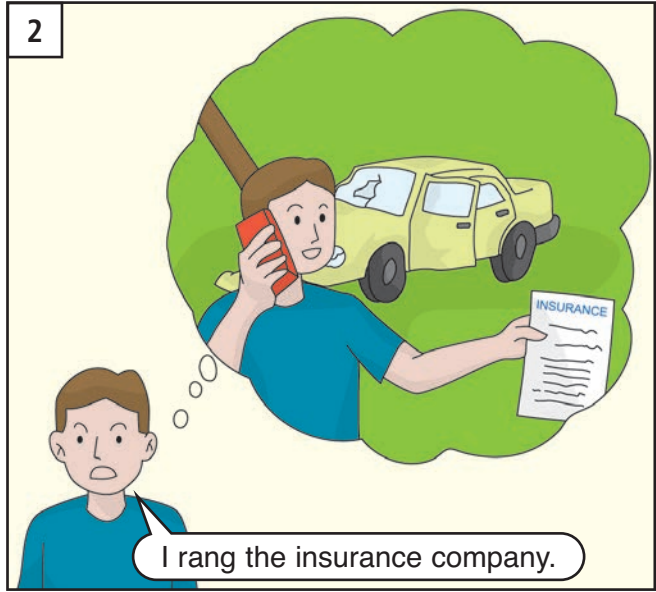
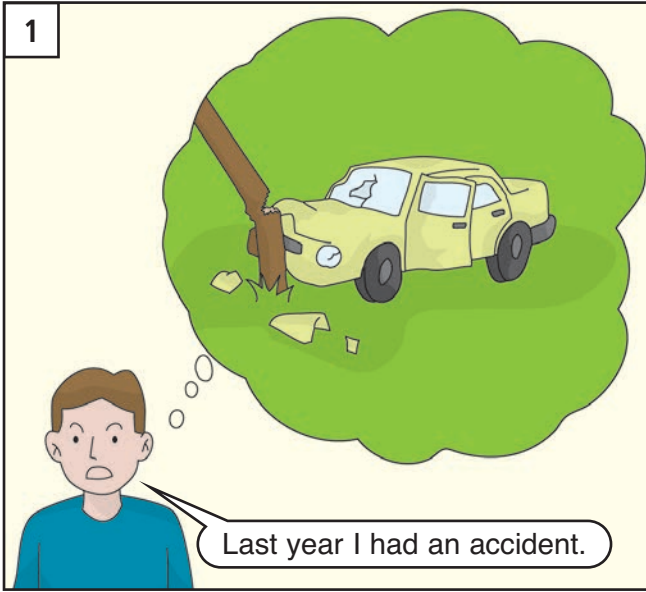

UNIT 14

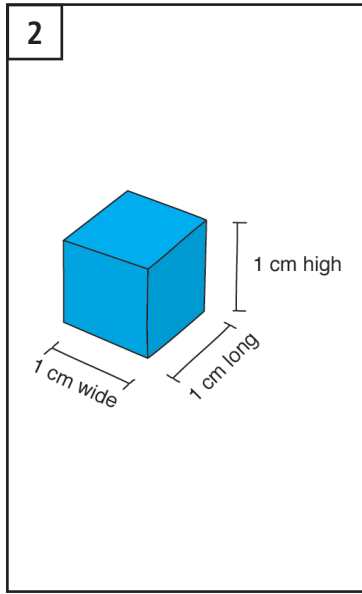
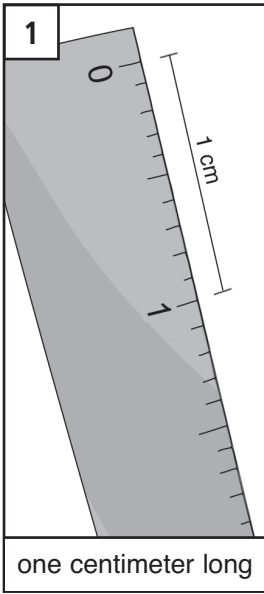

3

One centimeter multiplied by a hundred equals one meter.

$1 \text{ cm} \times 100 = 1 \text{ m}$   
 $1 \text{ m} \times 1000 = 1 \text{ km}$

One meter multiplied by a thousand equals one kilometer.

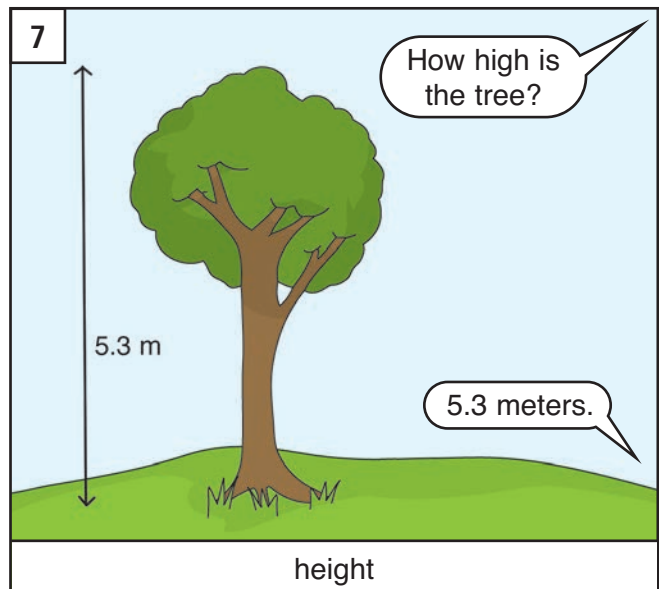
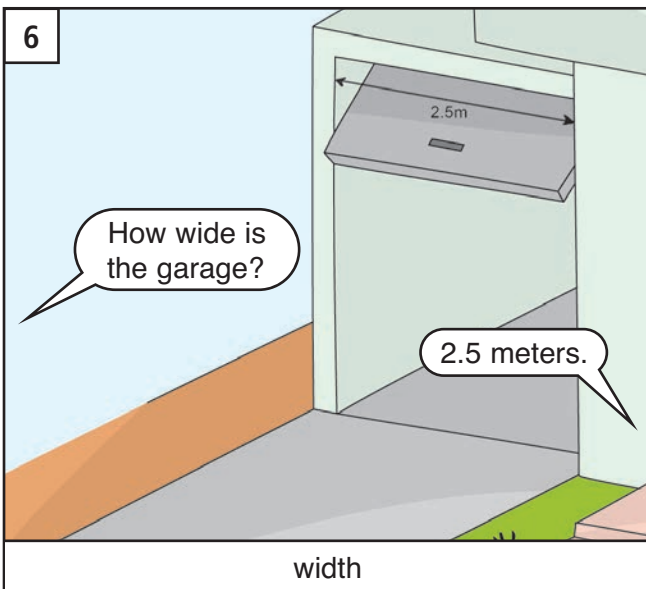
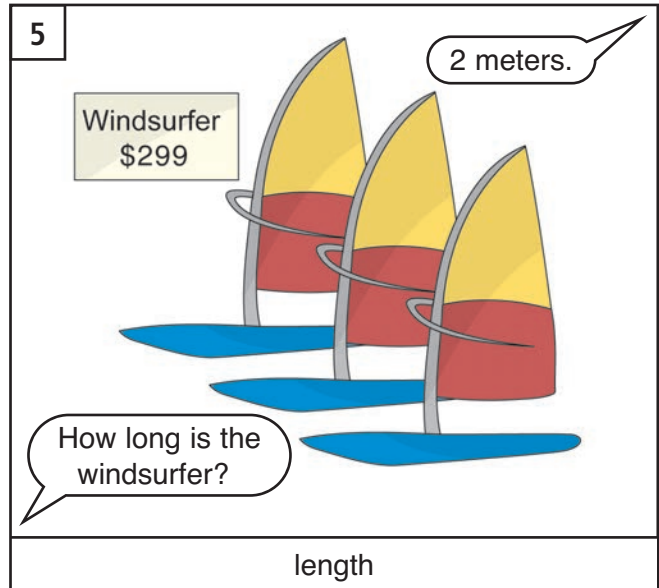
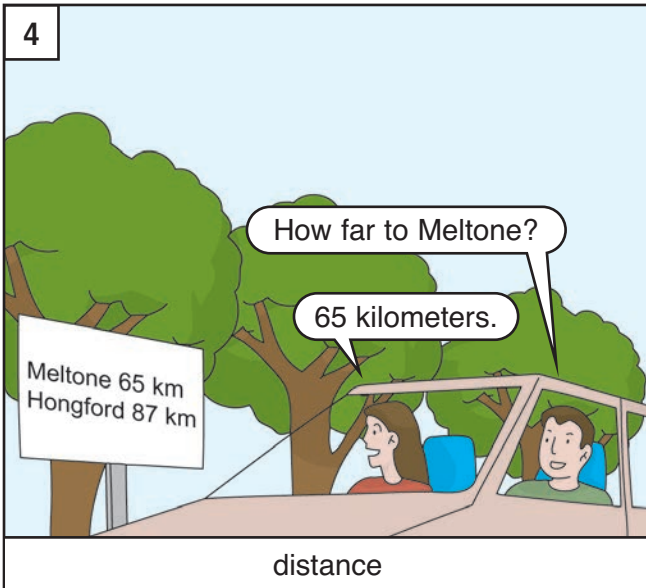



# The Bensons

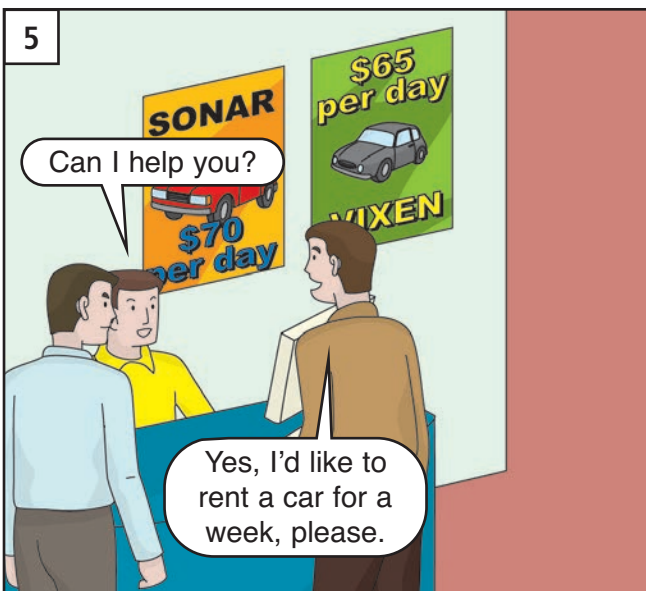
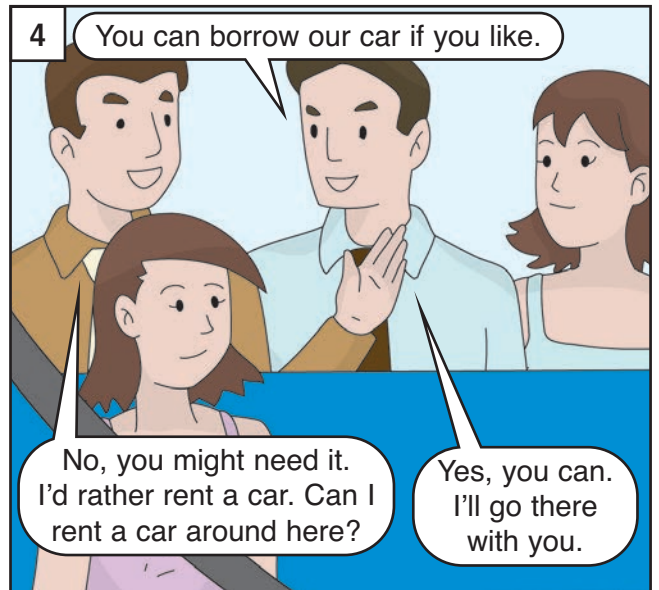
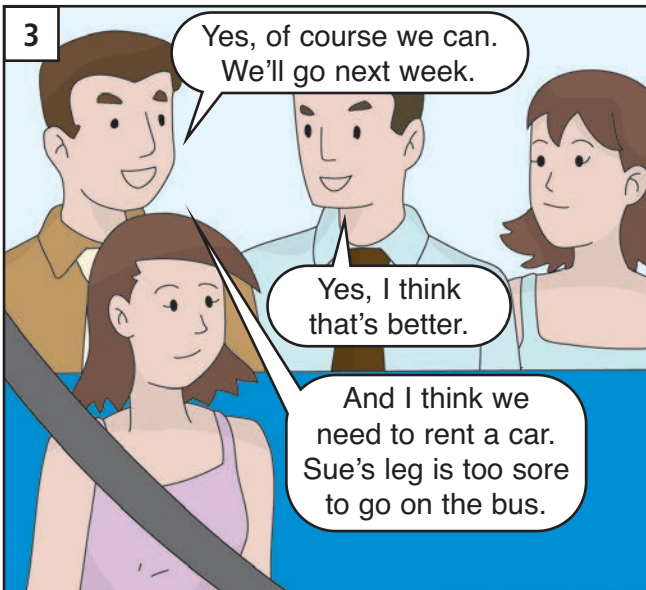
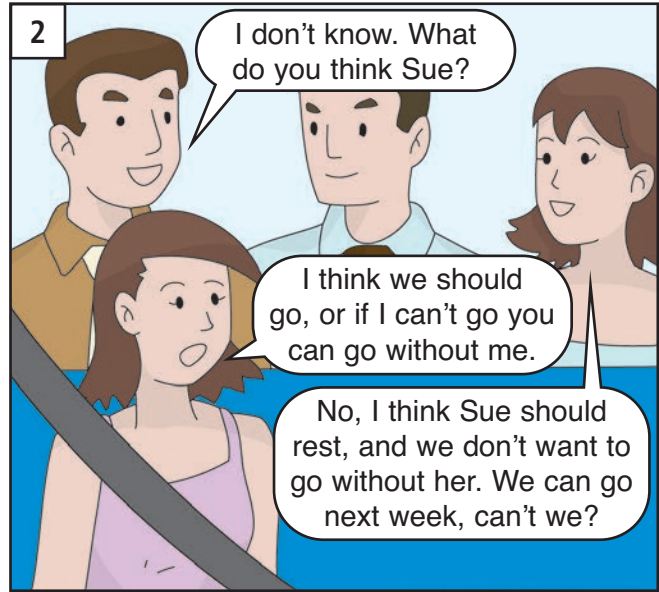

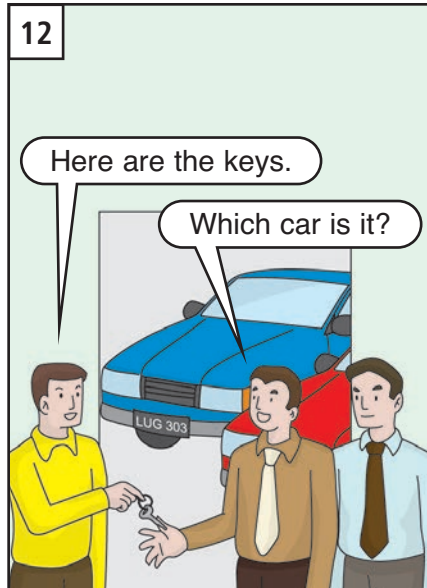
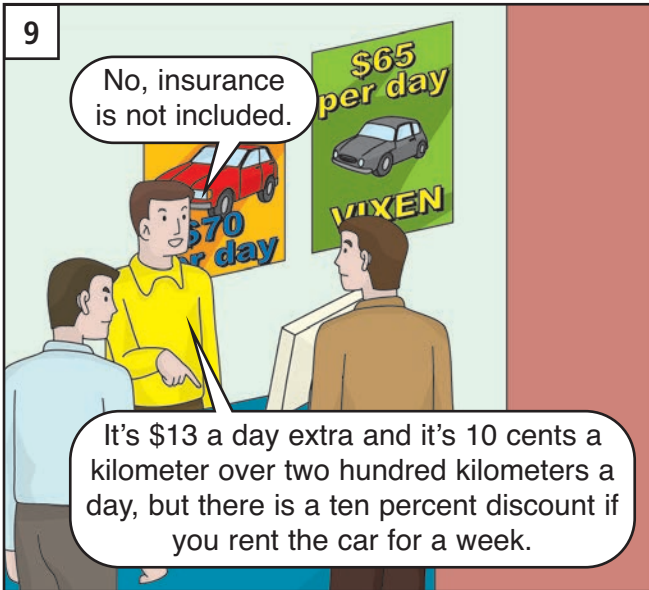
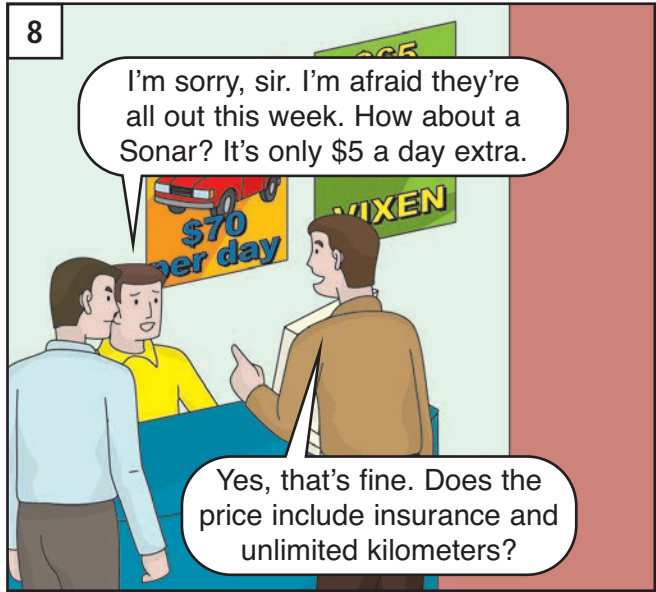
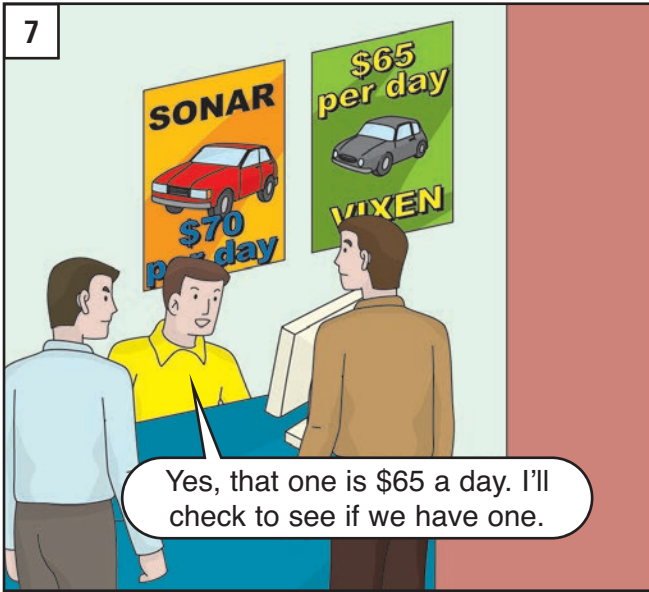

# UNIT 15: Revision and extension

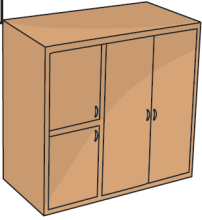
1   
wardrobe  
.....

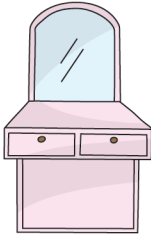
2   
.....

3   
.....

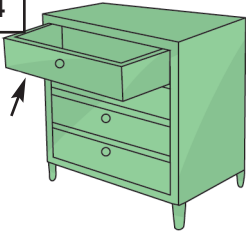
4   
.....

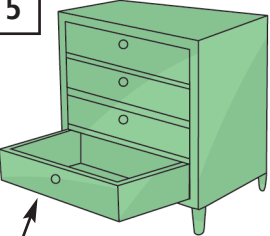
5   
.....

6   
.....

7   
.....

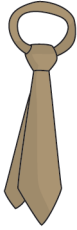
8   
.....

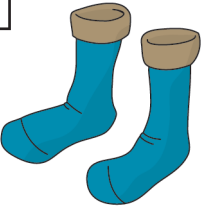
9   
.....

10   
.....

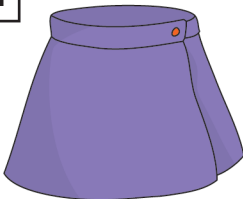
11   
.....

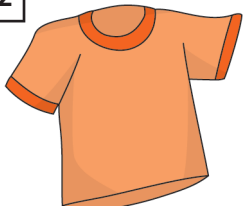
12   
.....

13   
.....

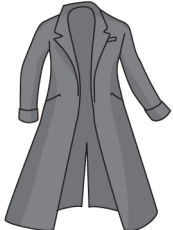
14   
.....

15   
.....

16   
.....

17   
.....

18   
.....

19   
.....

20   
.....

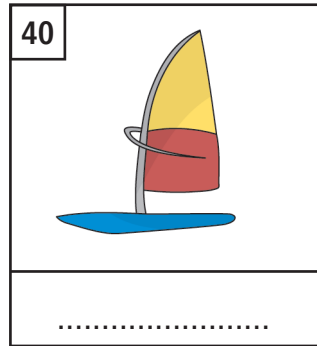
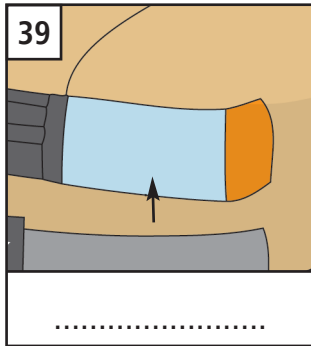
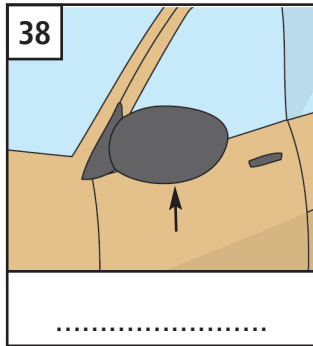
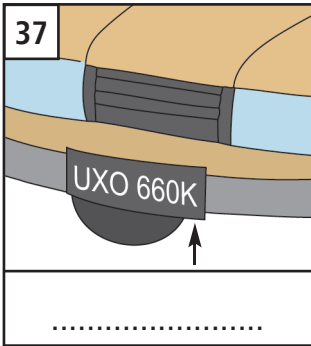
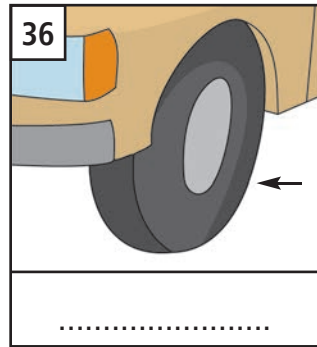
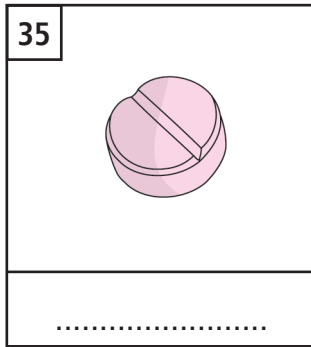
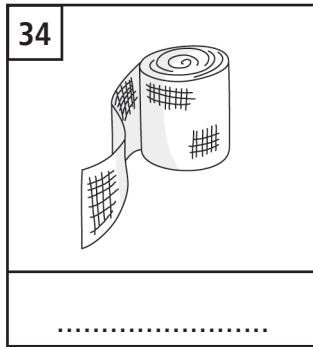
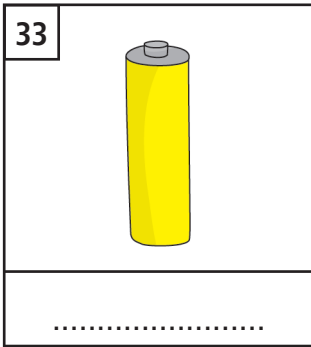
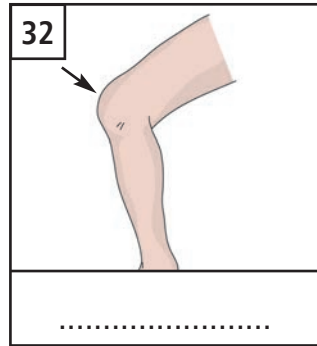
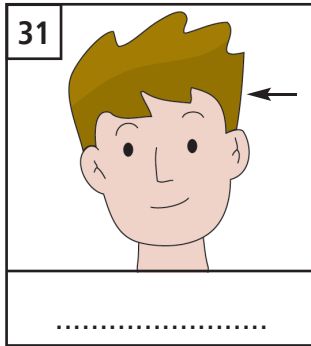
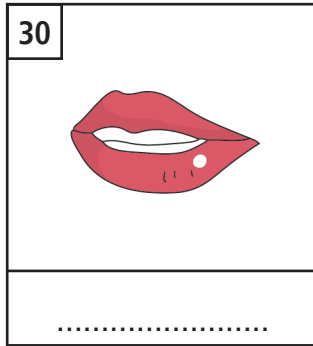
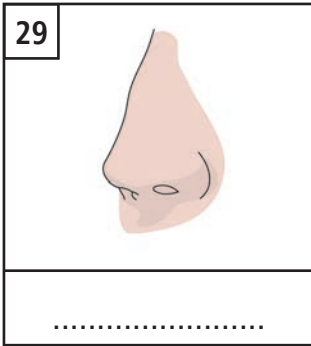
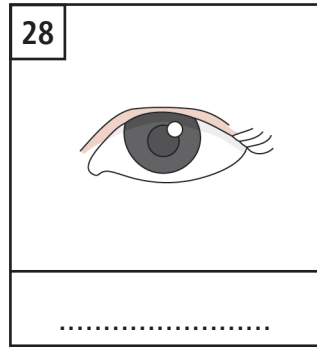
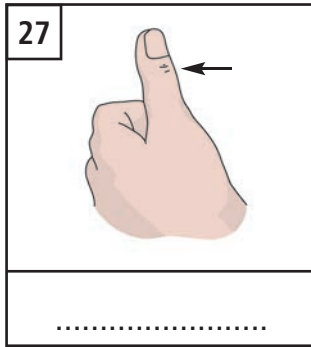
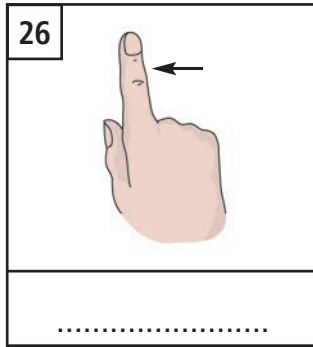
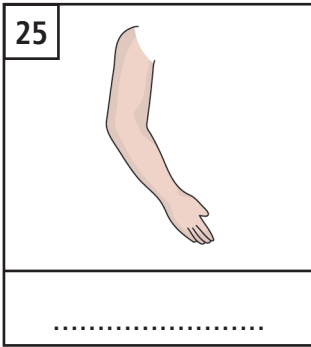
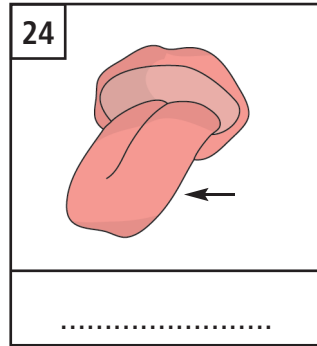
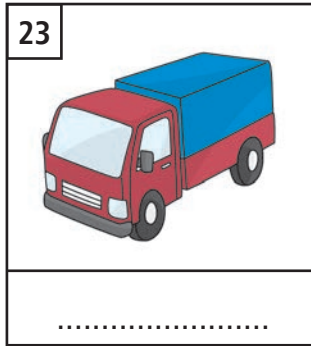
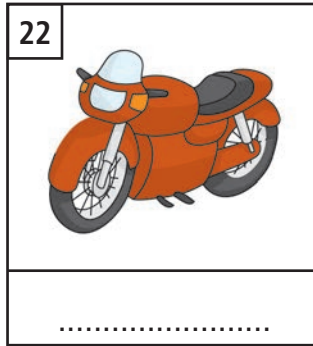
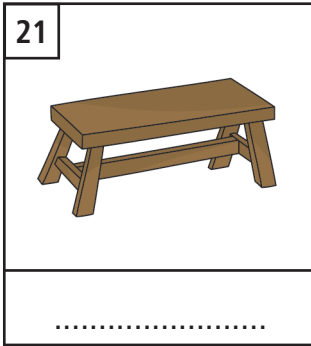

## UNIT 15

### A

- |                         |                                |
|-------------------------|--------------------------------|
| 1. What's the matter?   | a. You'd better have it fixed. |
| 2. Does it hurt?        | b. Good idea.                  |
| 3. Where's my T-shirt?  | c. Yes, it does.               |
| 4. We'd better go home. | d. In the top drawer.          |
| 5. My watch is broken.  | e. I hurt myself.              |

### B

- |                                    |                             |
|------------------------------------|-----------------------------|
| 1. What's the problem?             | a. You should get a refund. |
| 2. I've got a bad cough.           | b. OK.                      |
| 3. Will the bus come soon?         | c. You should stop smoking. |
| 4. There's a mark on my new shirt. | d. My finger's swollen.     |
| 5. Sign here please.               | e. In a few minutes.        |

### C

- |                                  |                                    |
|----------------------------------|------------------------------------|
| 1. I've burnt my hand.           | a. It might be in the car.         |
| 2. I'm very tired.               | b. Yes, 10%.                       |
| 3. I've got a toothache.         | c. You might need a bandage.       |
| 4. Does that include a discount? | d. You'd better go to the dentist. |
| 5. Where's the umbrella?         | e. You need to rest.               |

### D

- |                                |                                  |
|--------------------------------|----------------------------------|
| 1. My hand's swollen.          | a. Sure.                         |
| 2. I'm cold.                   | b. You'd better get another one. |
| 3. Can I borrow your pen?      | c. You'd better see a doctor.    |
| 4. This chair's uncomfortable. | d. Yes, 10%.                     |
| 5. Do you need a deposit?      | e. You should put on a jumper.   |

show

you

to

better

refund

on



UNIT 15

too,

before

your

rather

deposit

one

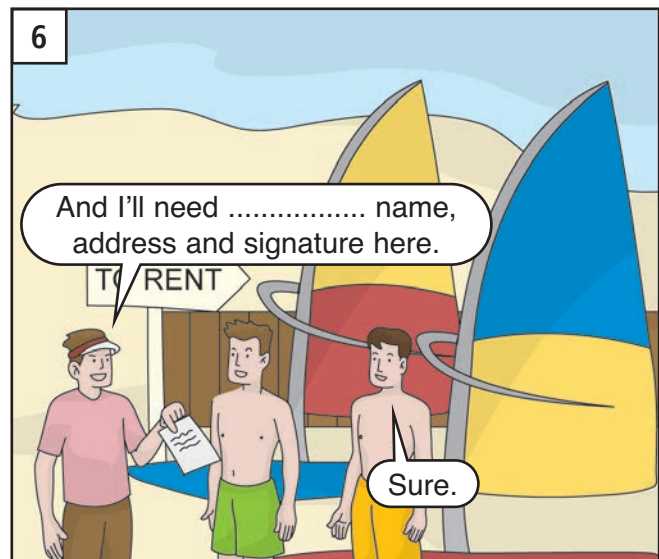
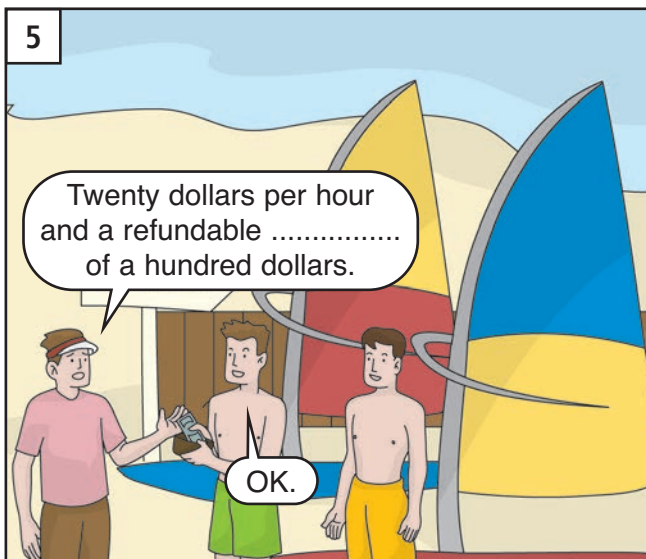
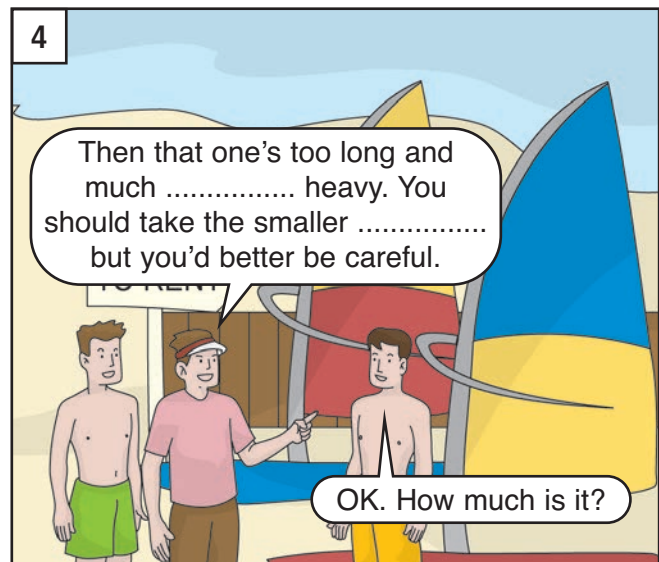
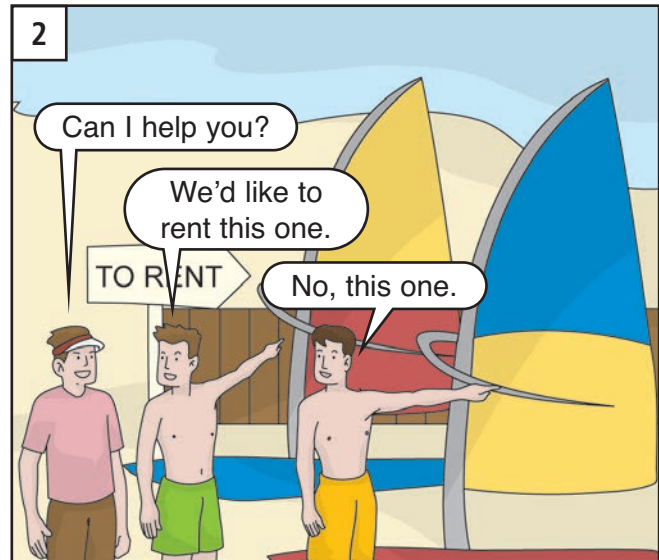
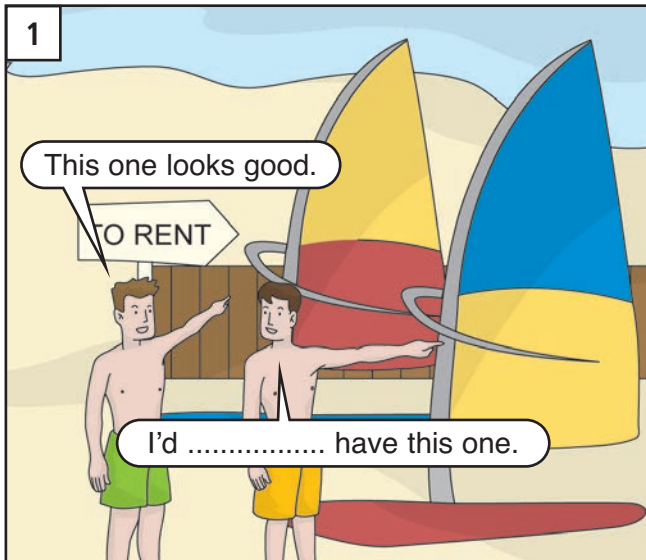

it the doesn't to new If there's few at when

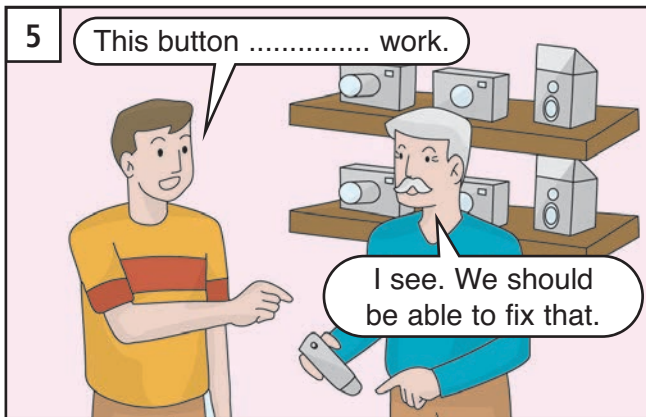
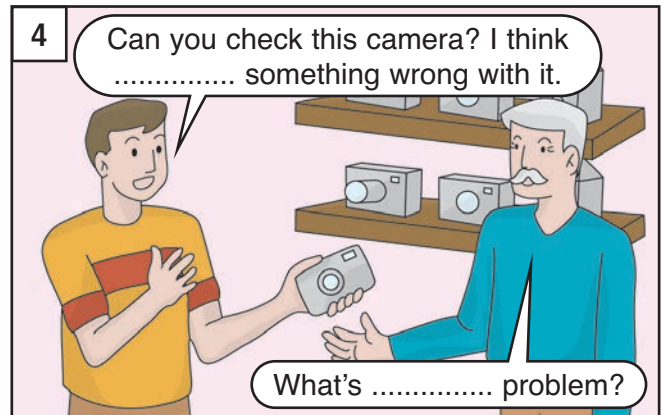

should

borrow

know

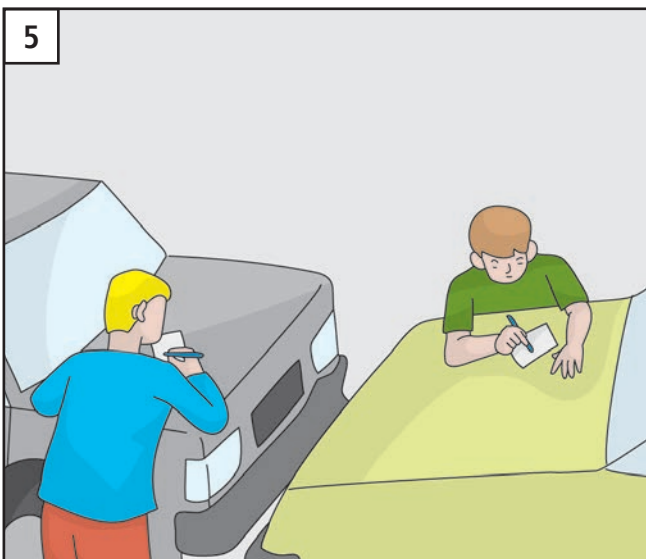
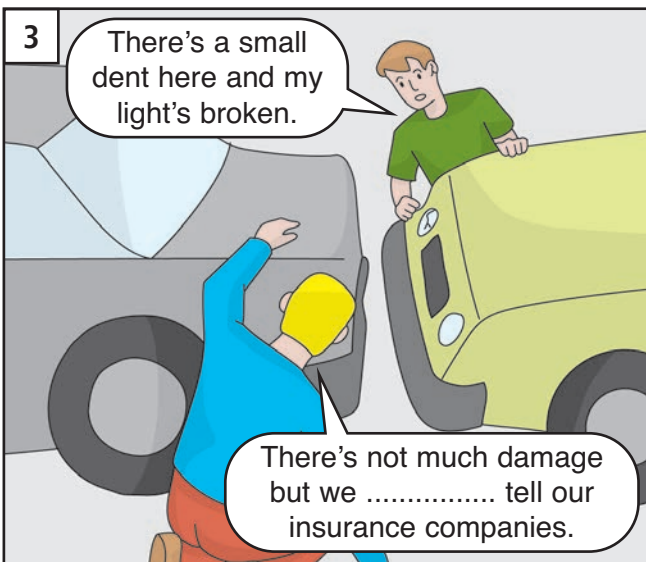
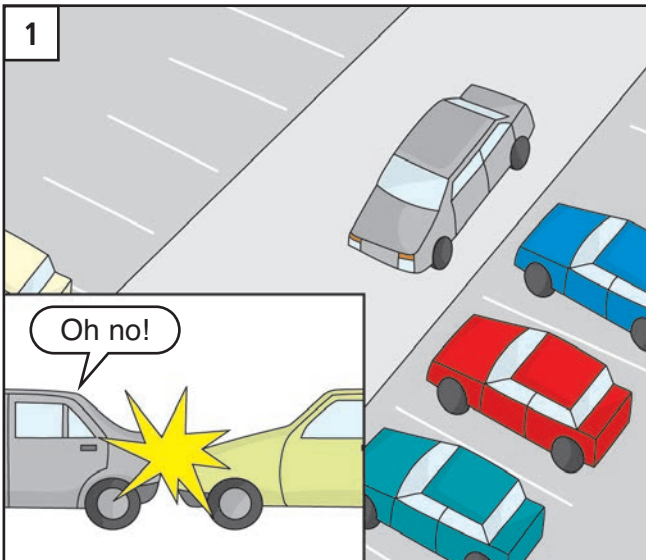

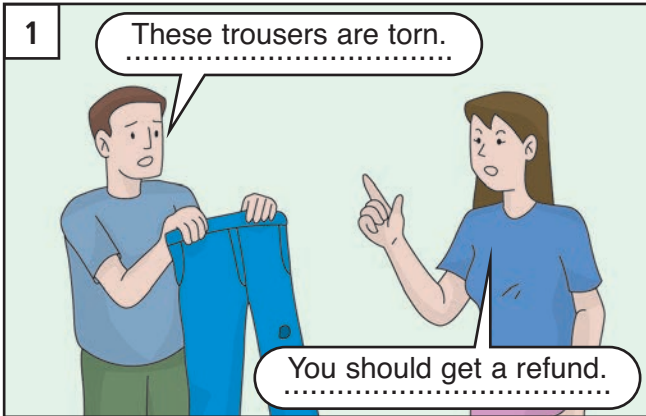

- trousers These torn are
- a get You refund should

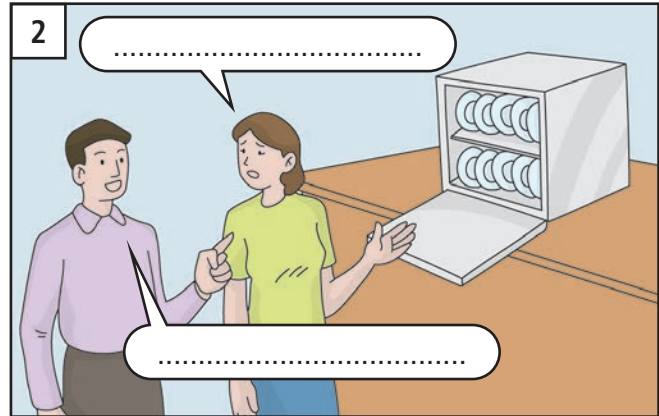

- dishwasher doesn't The work
- better it have fixed We'd

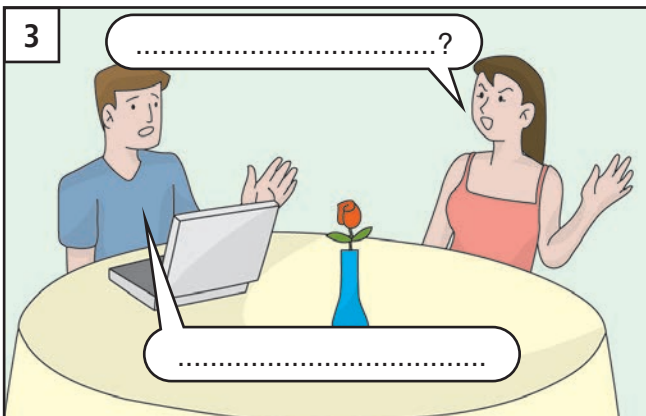

- laptop you bring did your Why
- case In some do work I



- I Can a this refund for get shirt
- got Have receipt a you



- headache a got I've
- too got I've one

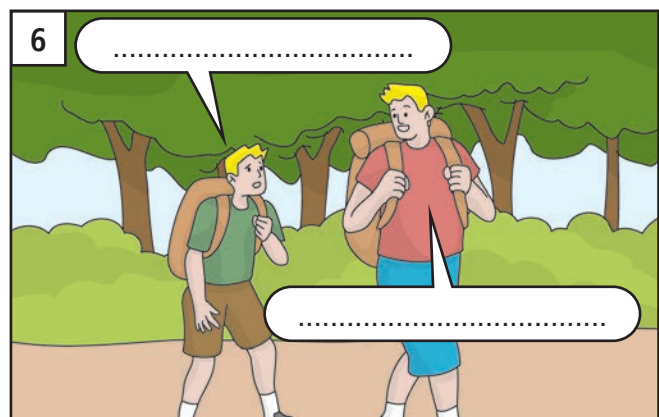

- walked kilometers ten We've
- tired be must You

UNIT 15



- doesn't telephone This work
- work either one doesn't This

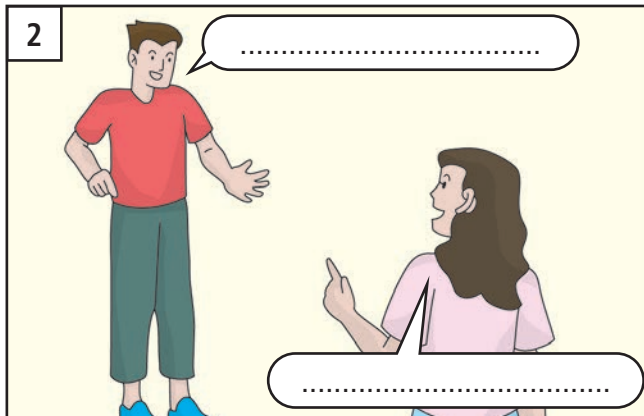

- are too trousers These small new
- better them exchange You'd

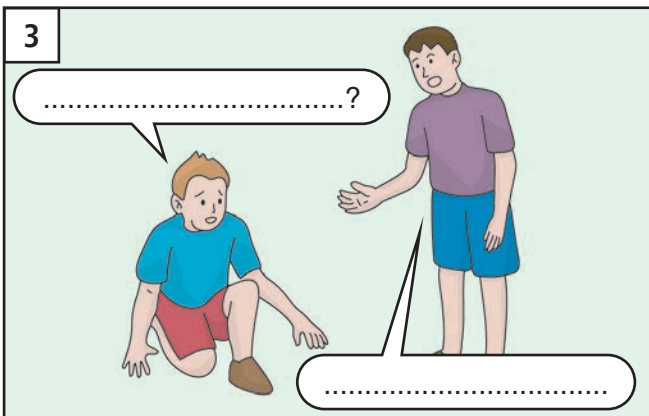

- my phone Where's mobile
- in It the might kitchen be

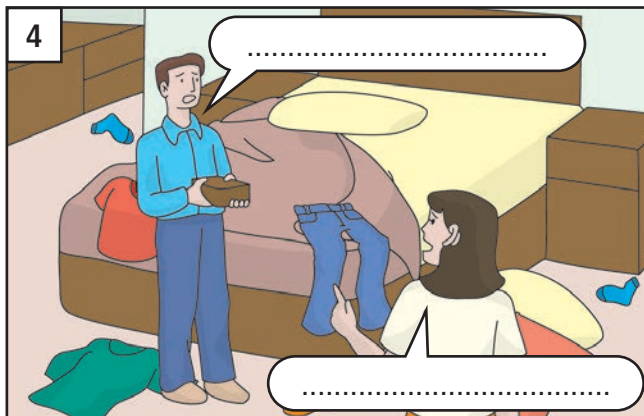

- I my find can't license driver's
- It here must be around somewhere

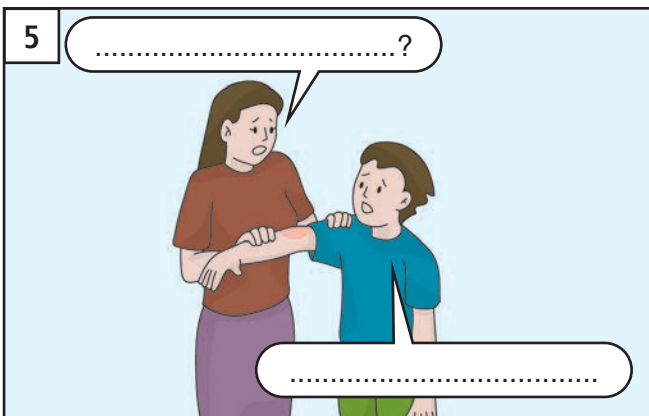

- matter What's the
- a on got my rash arm I've

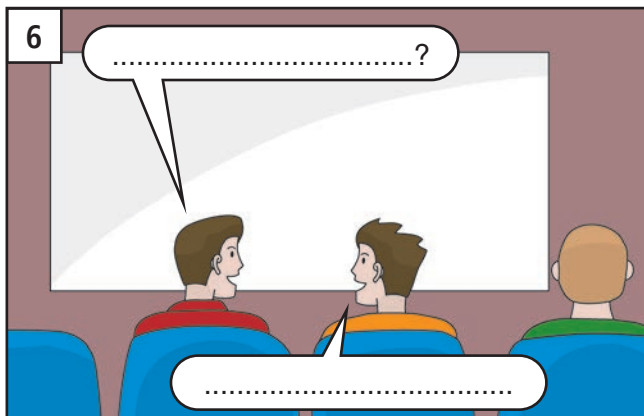

- When the start does movie
- few In minutes a

## Answers to Unit 15

### Unit 15, page 132

- |             |             |                     |               |                  |
|-------------|-------------|---------------------|---------------|------------------|
| 1. wardrobe | 2. dresser  | 3. chest of drawers | 4. top drawer | 5. bottom drawer |
| 6. shirt    | 7. jeans    | 8. tie              | 9. socks      | 10. dress        |
| 11. skirt   | 12. T-shirt | 13. jumper          | 14. coat      | 15. suit         |
| 16. hat     | 17. pants   | 18. bra             | 19. trousers  | 20. stockings    |

### Unit 15, page 133

- |            |                         |             |             |                |
|------------|-------------------------|-------------|-------------|----------------|
| 21. bench  | 22. motorbike           | 23. truck   | 24. tongue  | 25. arm        |
| 26. finger | 27. thumb               | 28. eye     | 29. nose    | 30. mouth      |
| 31. hair   | 32. knee                | 33. battery | 34. bandage | 35. tablet     |
| 36. wheel  | 37. registration number | 38. mirror  | 39. lights  | 40. windsurfer |

### Unit 15, page 134

- A. 1e 2c 3d 4b 5a      B. 1d 2c 3e 4a 5b      C. 1c 2e 3d 4b 5a      D. 1c 2e 3a 4b 5d

### Unit 15, page 135

1. on, better                      3. show                      4. to, refund                      5. you

### Unit 15, page 136

1. rather                      3. before                      4. too, one                      5. deposit                      6. your

### Unit 15, page 137

- |            |            |       |                 |
|------------|------------|-------|-----------------|
| 1. new     | 2. when    | 3. to | 4. there's, the |
| 5. doesn't | 6. it, few | 7. if | 8. at           |

### Unit 15, page 138

2. know                      3. should                      4. borrow

### Unit 15, page 139

1. These trousers are torn.  
You should get a refund.
2. The dishwasher doesn't work.  
We'd better have it fixed.
3. Why did you bring your laptop?  
In case I do some work.
4. Can I get a refund for this shirt?  
Have you got a receipt?
5. I've got a headache.  
I've got one too.
6. We've walked ten kilometers.  
You must be tired.

### Unit 15, page 140

1. This telephone doesn't work.  
This one doesn't work either.
2. These new trousers are too small.  
You'd better exchange them.
3. Where's my mobile phone?  
It might be in the kitchen.
4. I can't find my driver's license.  
It must be around here somewhere.
5. What's the matter?  
I've got a rash on my arm.
6. When does the movie start?  
In a few minutes.

## UNIT 16: Can I try them on?

price  
half price  
sale  
special

anything else

try on  
size  
just right

over there

other  
other one  
same

pair of

1

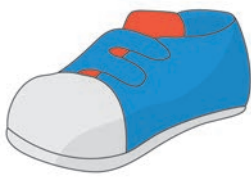

a shoe

2

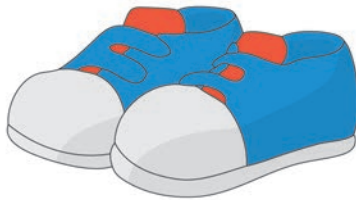

a pair of shoes

3



the size

4

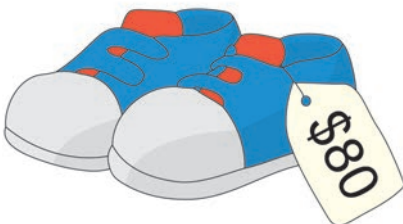

the price

5

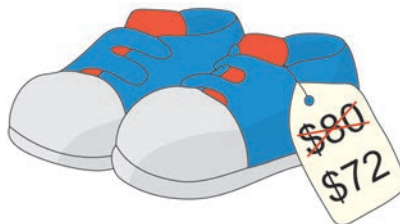

10% off

6

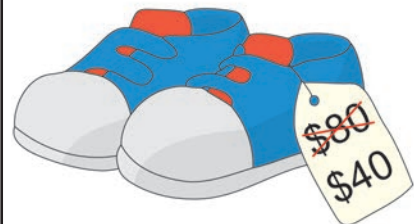

Half price

1

The big one is more expensive than the small one.

2

The small one is more expensive than the big one.

3

They are the same price.

4

Look. They're having a sale. Everything is cheap.

5

Look they're on special. They're only half price.

6

Can I try them on?

Yes, of course.

They're too small.

7

Can I try them on?

Yes, of course.

You can try them on over there.

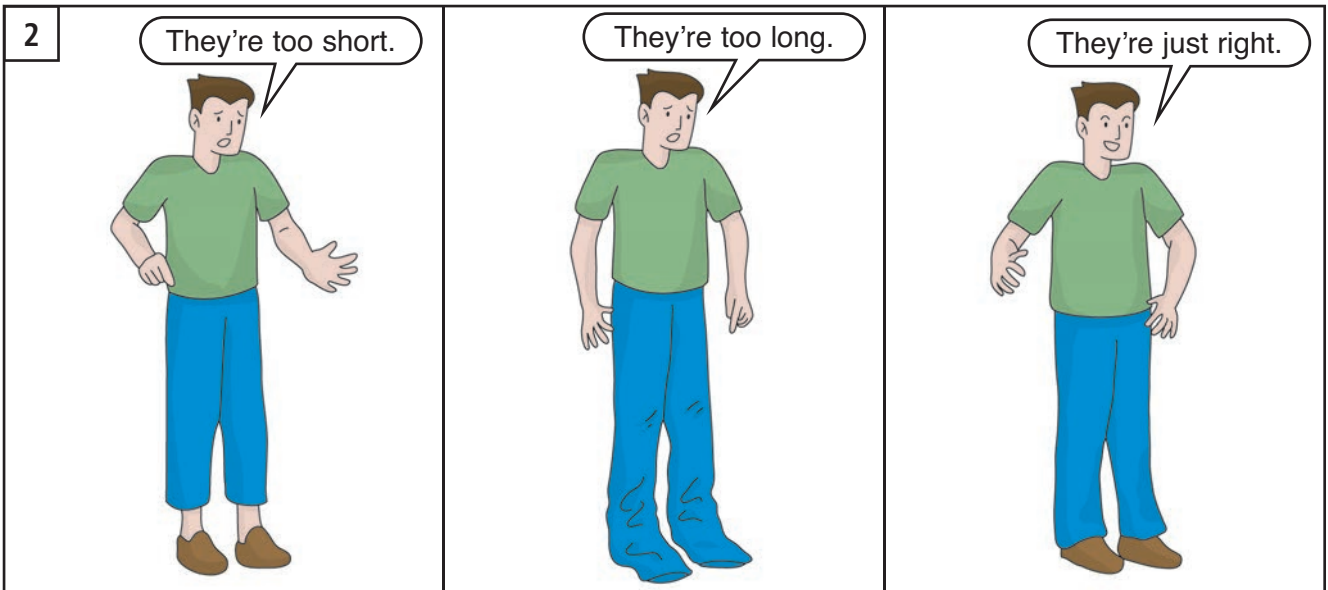
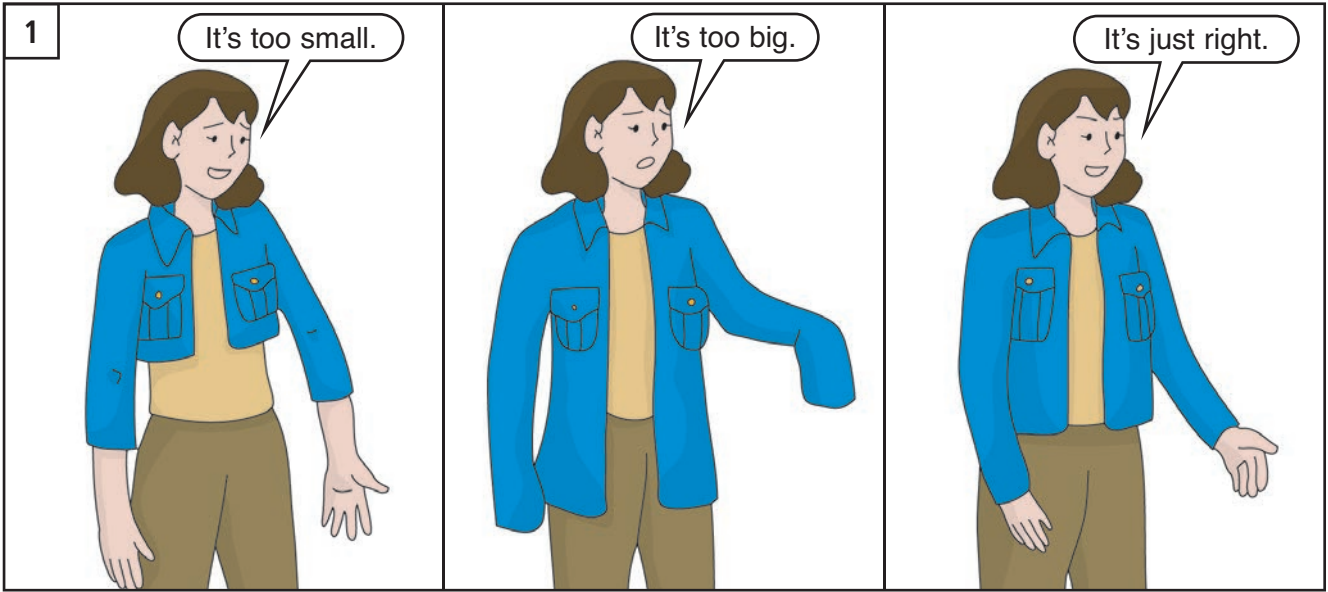

1

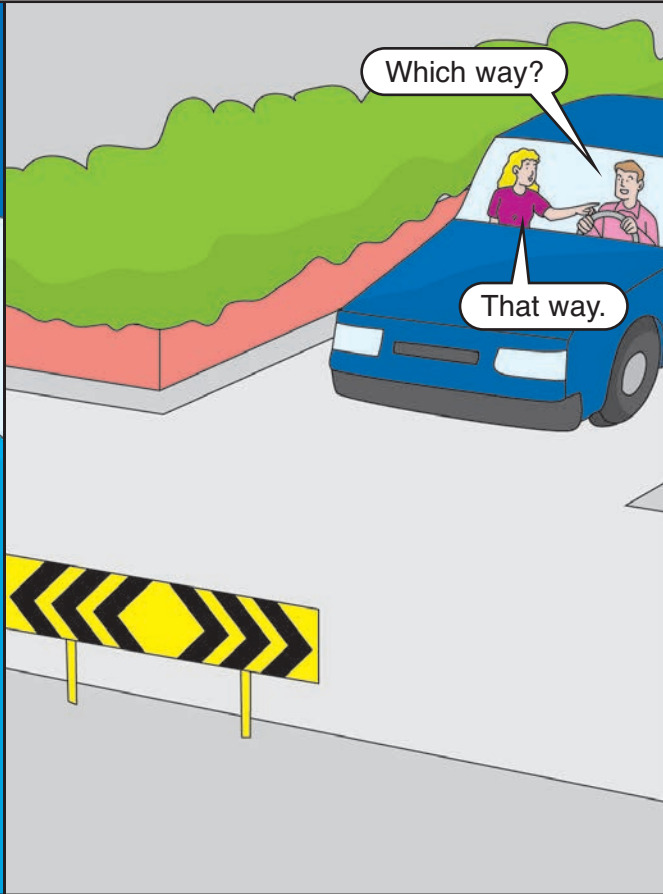

2



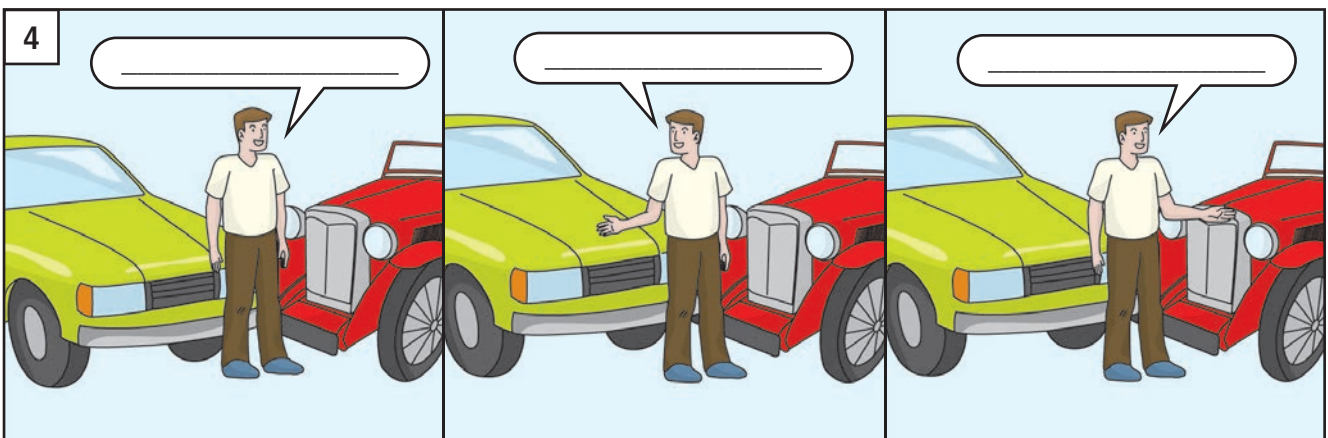
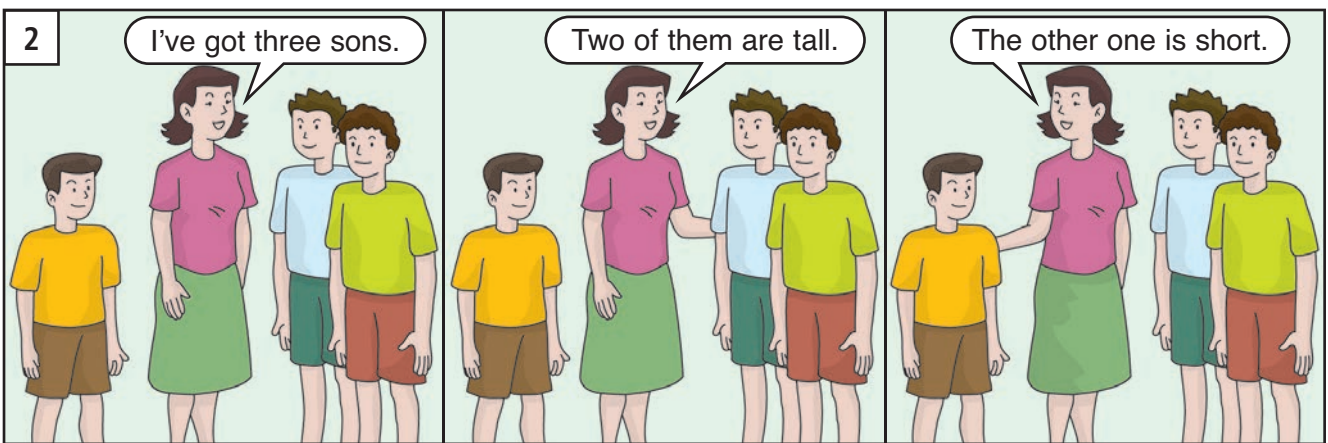
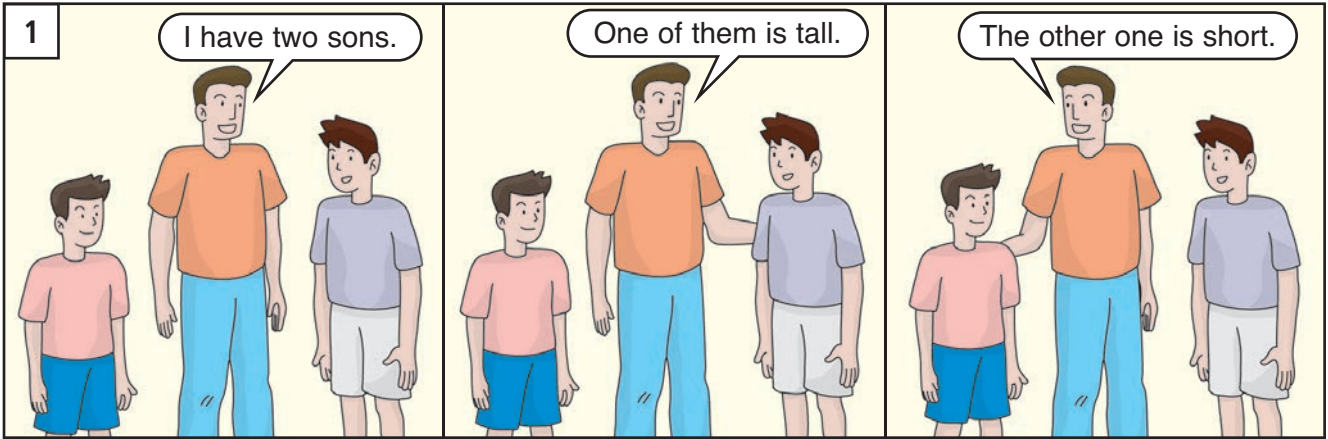

Can I try them on?

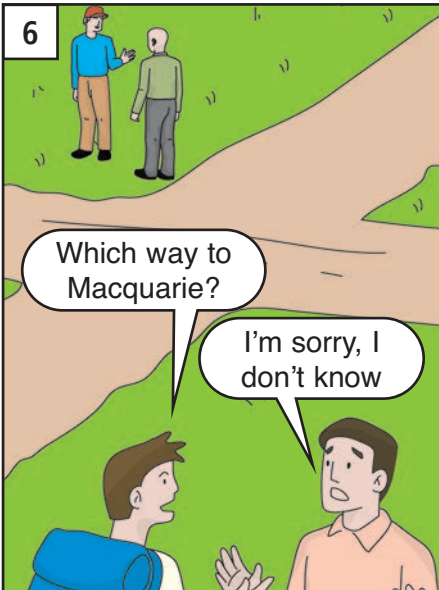

# The Bensons

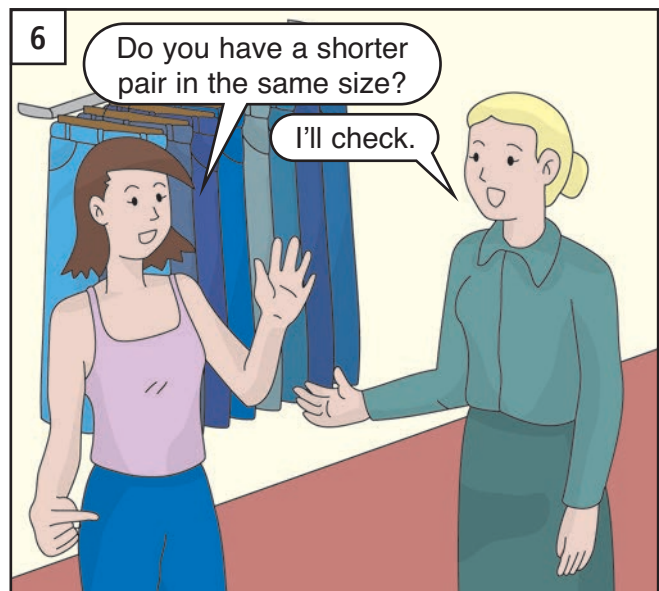
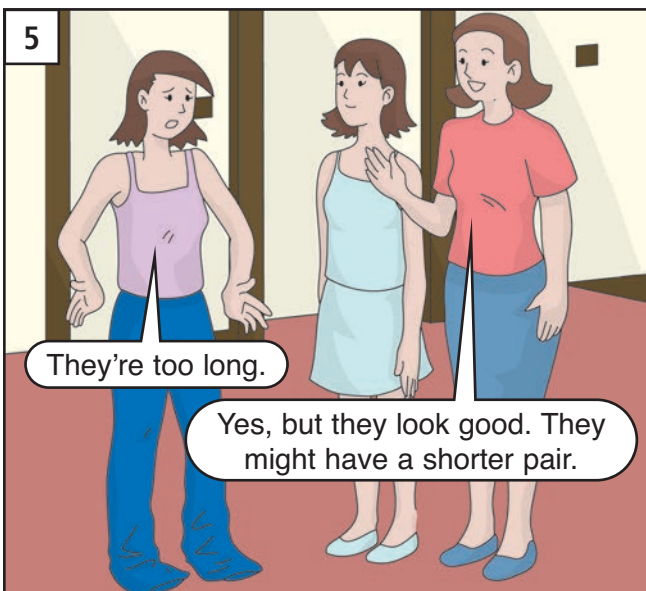
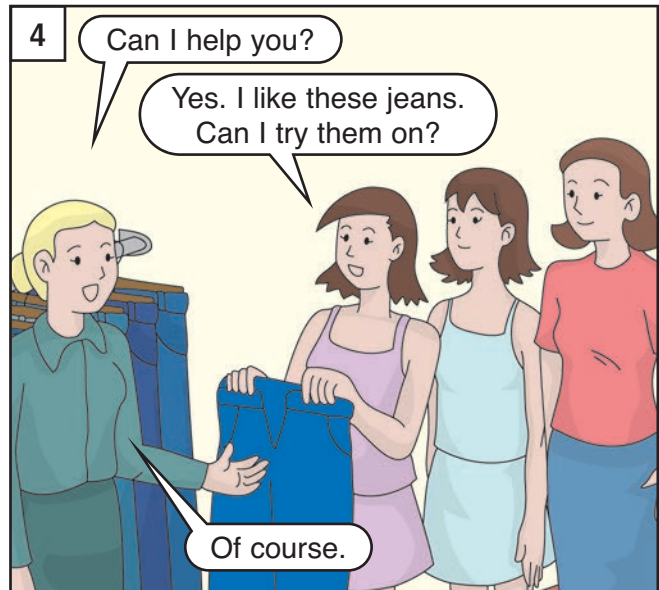

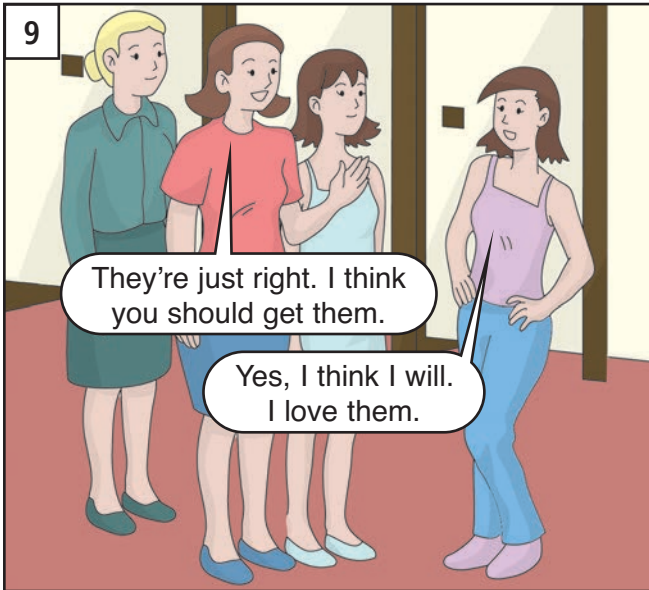

# UNIT 17: Neither can I.

everywhere  
everyone  
everything

menu  
entrée  
main course  
dessert  
order  
serve  
service

recommend  
delicious  
terrible

onion  
carrot  
bean  
peas  
cabbage  
cauliflower  
tomato  
potato  
vegetable  
bunch

plate  
bowl  
rice  
soup

cow                  sheep  
pig                    fish

beef  
lamb  
pork

until  
so  
neither

hungry  
thirsty

swim

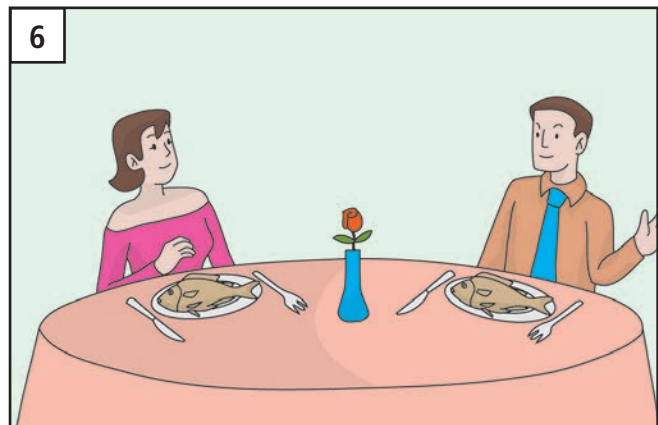
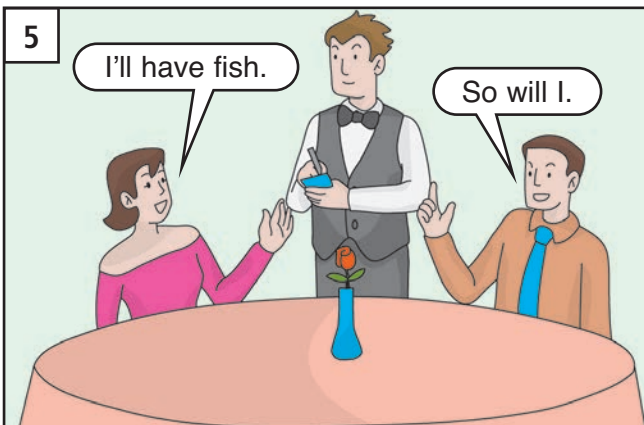
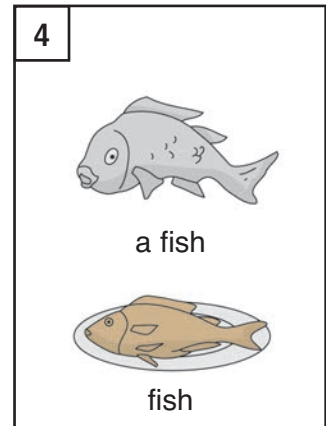
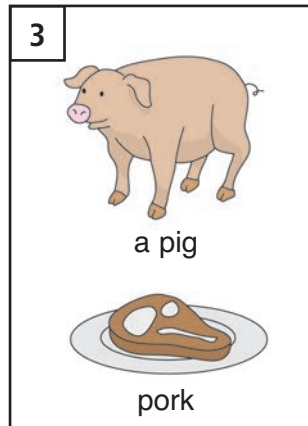
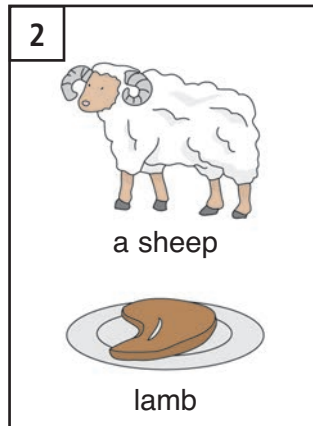
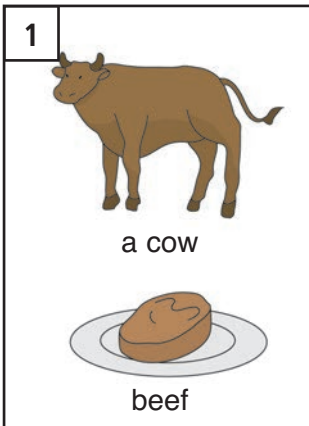

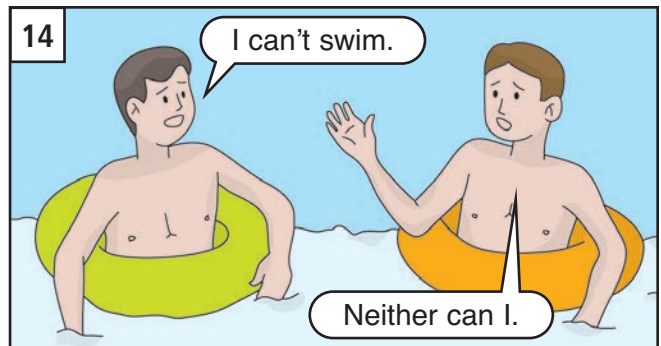
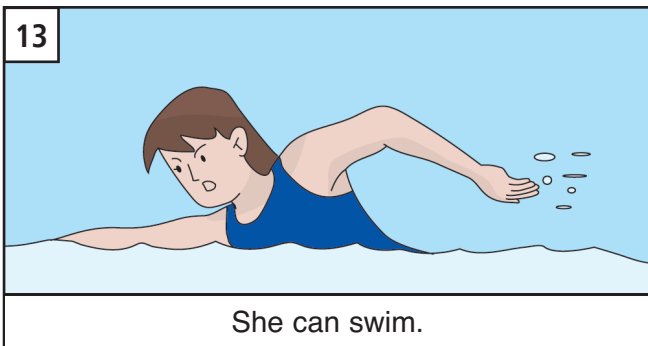
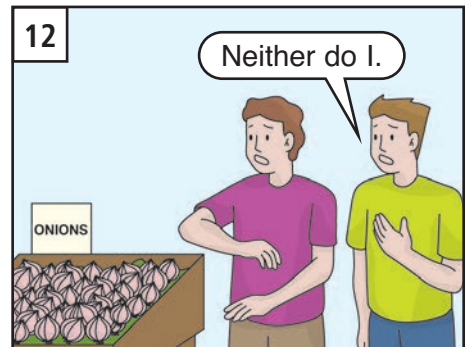
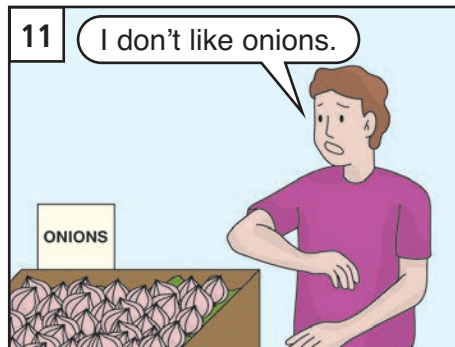
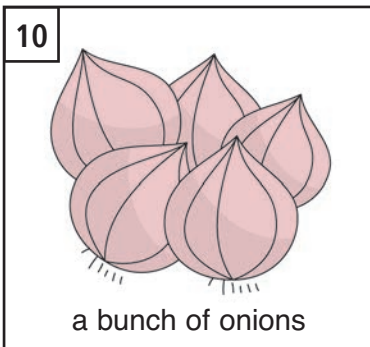
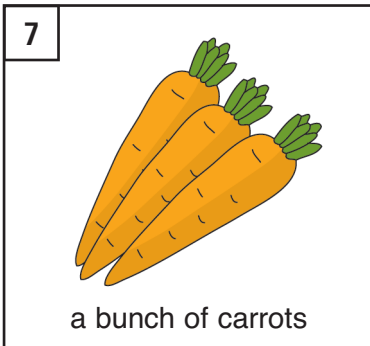
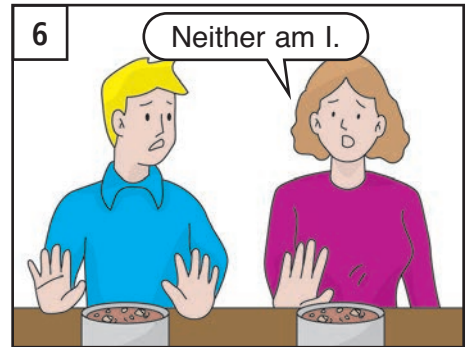
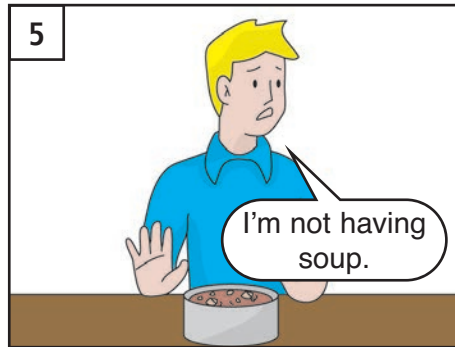
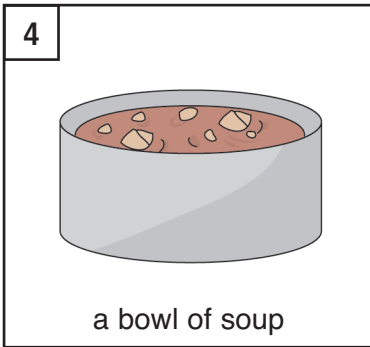
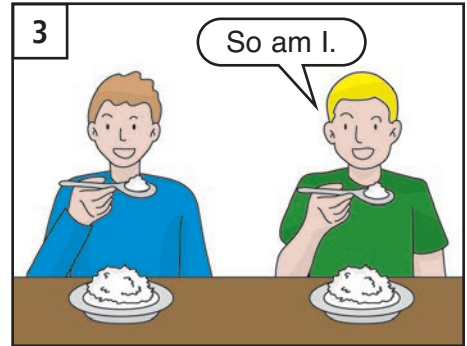
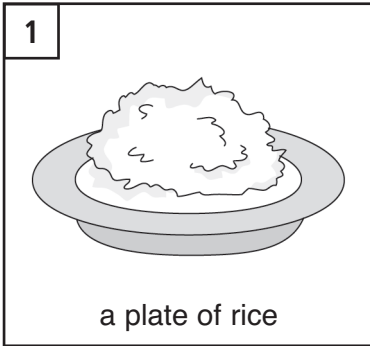



In the vegetable garden

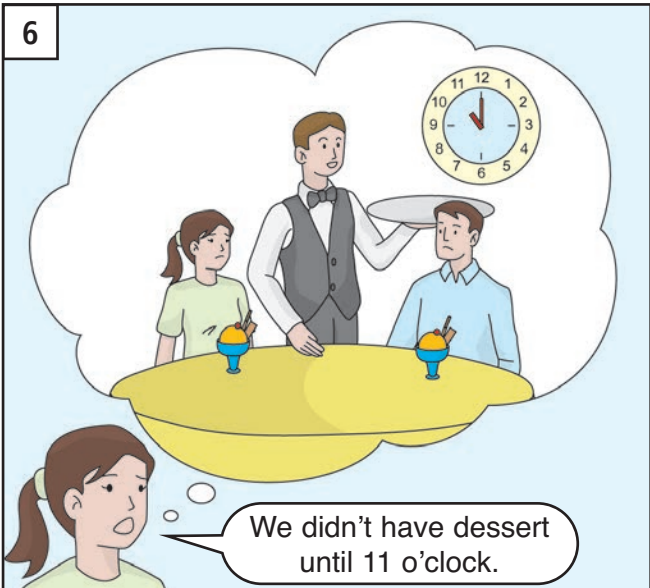
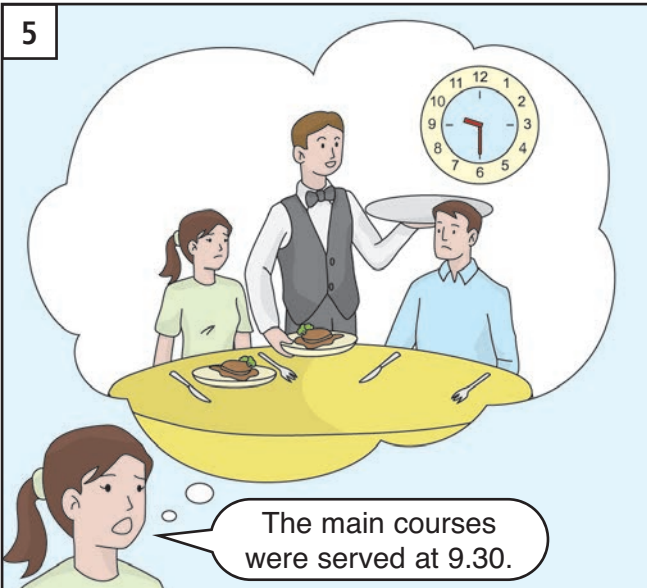
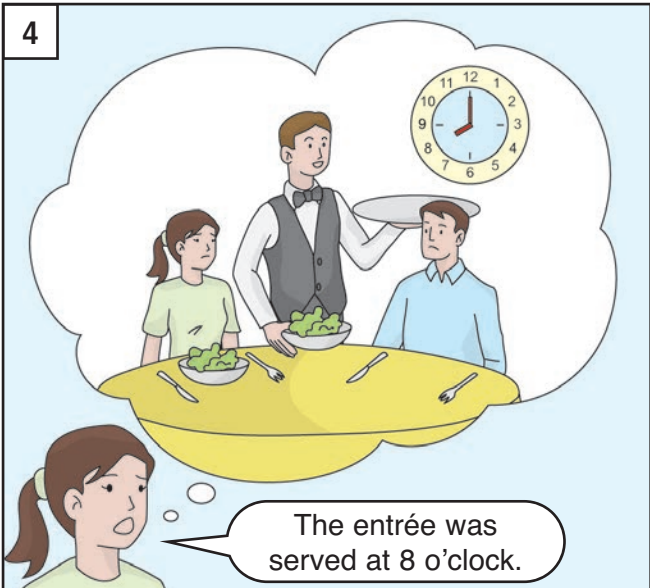
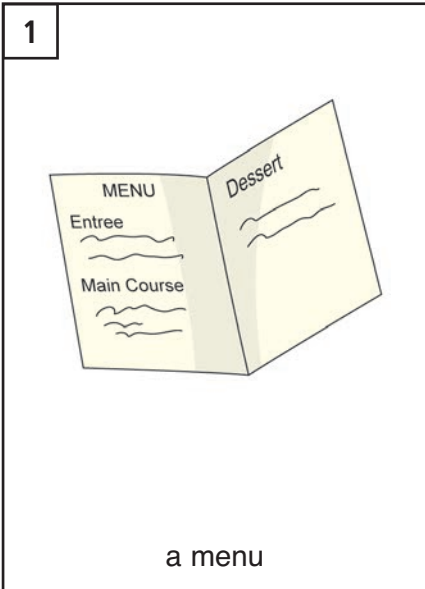

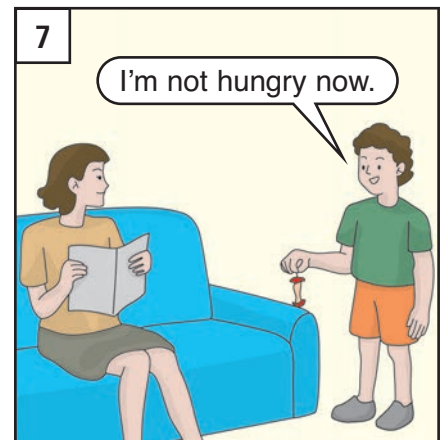
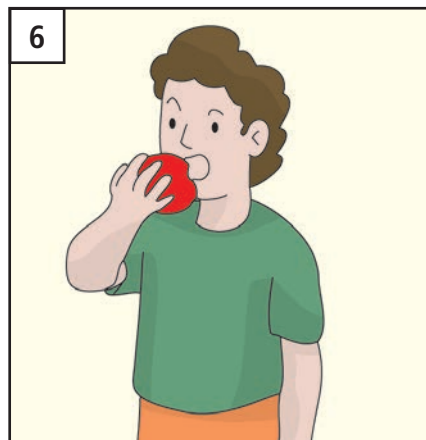
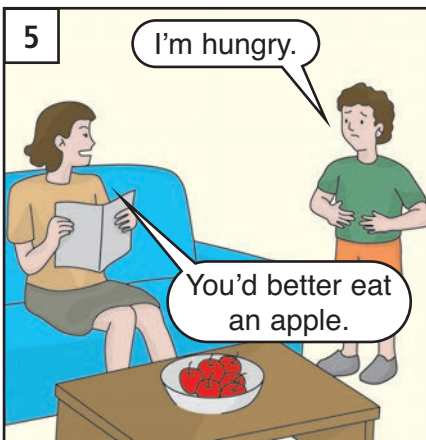
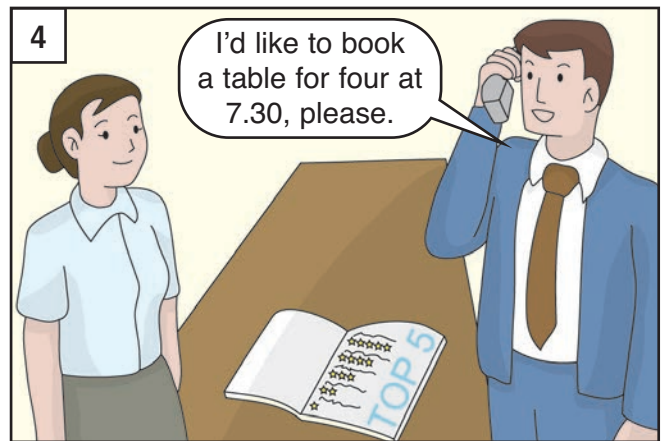

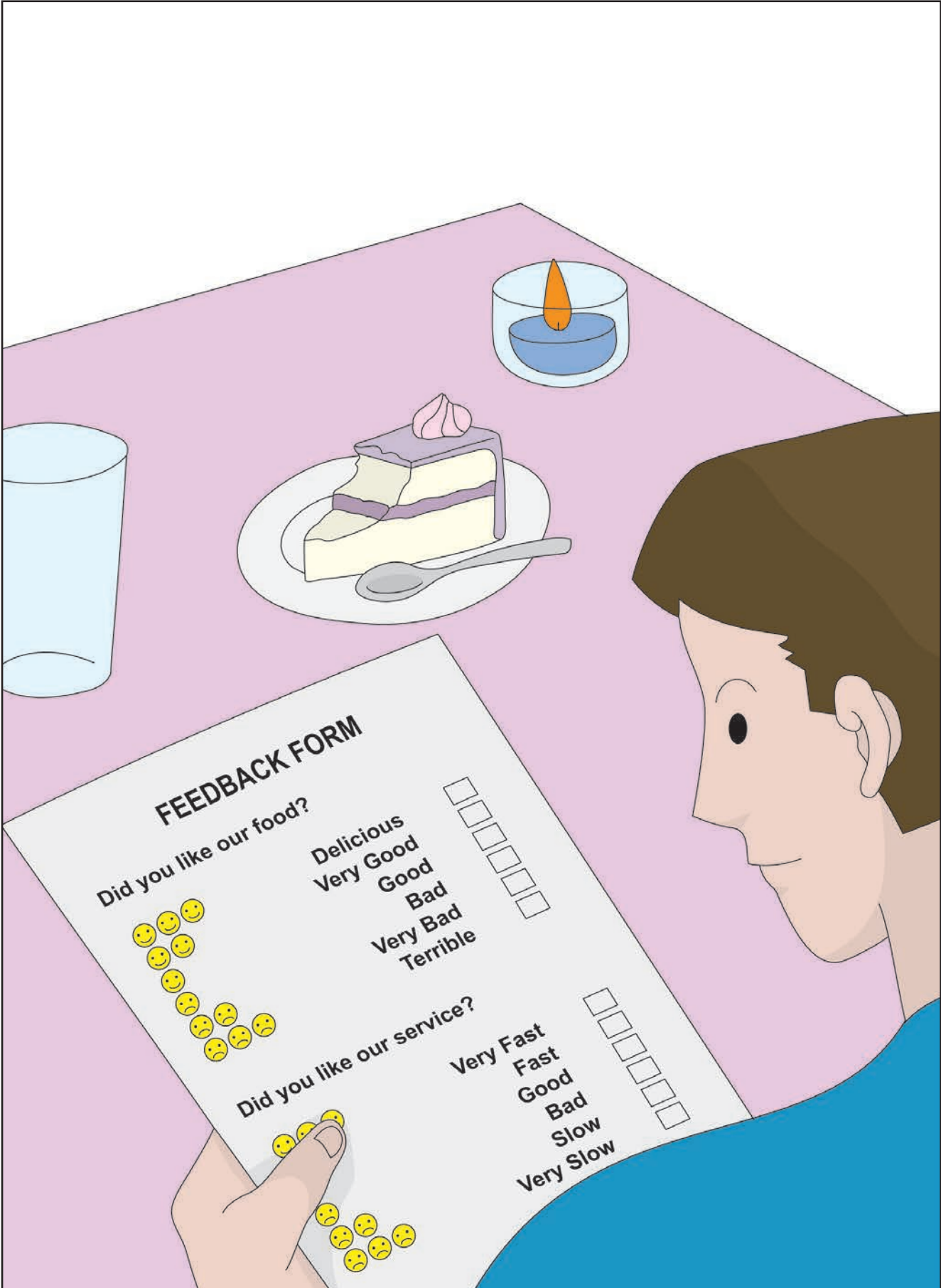

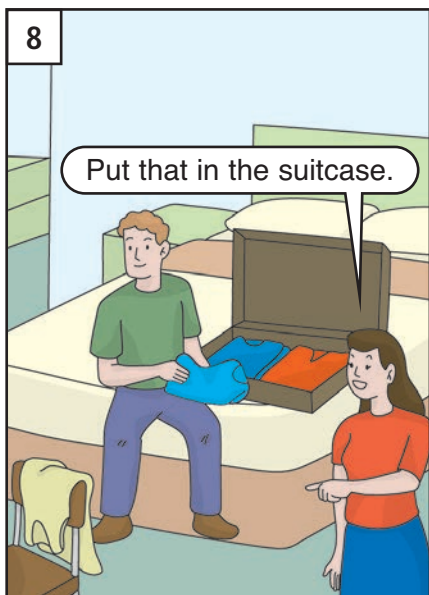
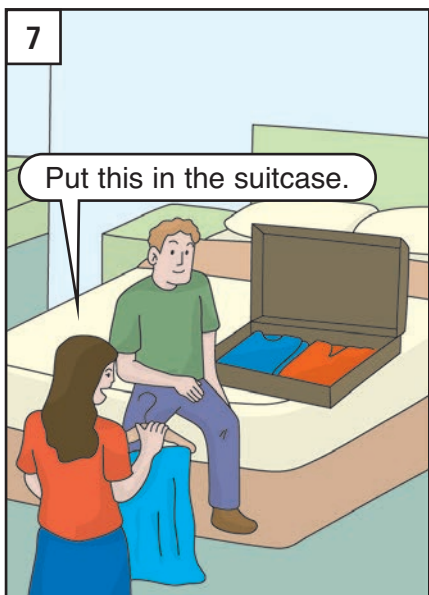

# The Bensons

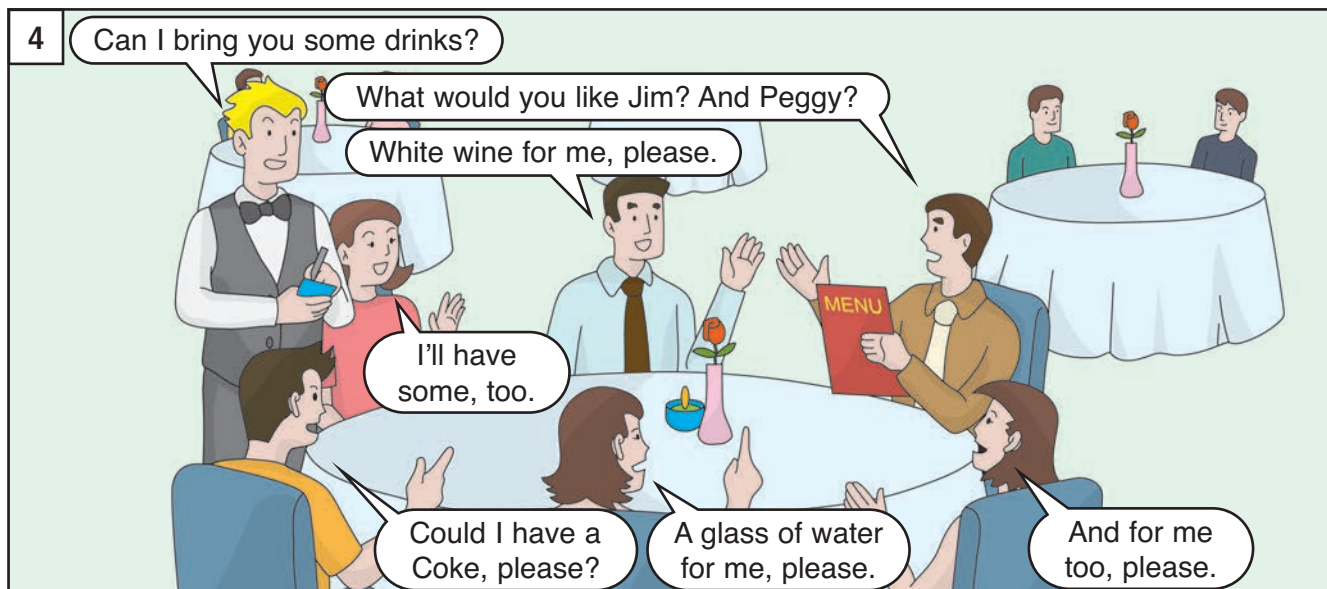
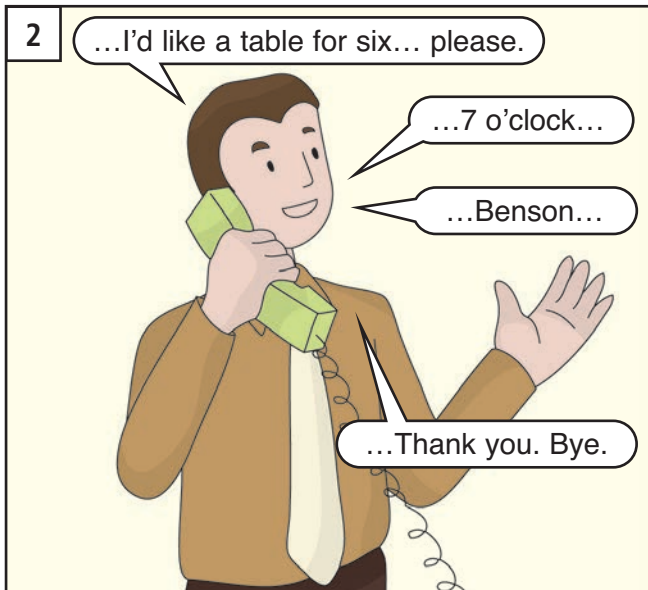
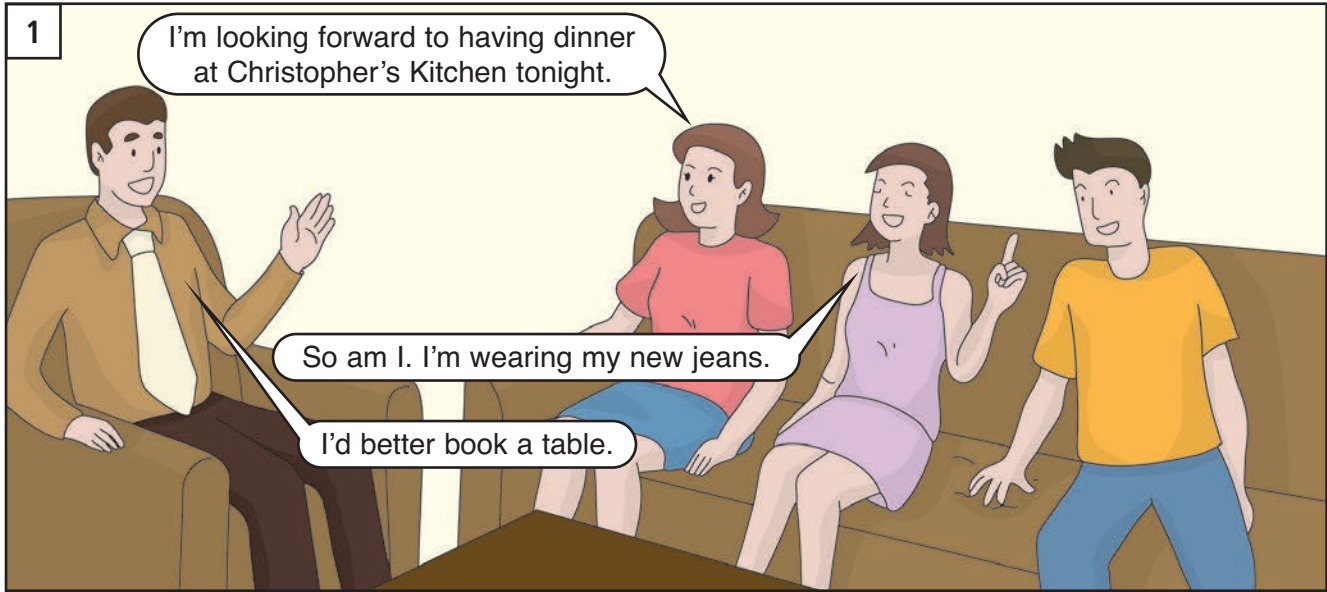



9

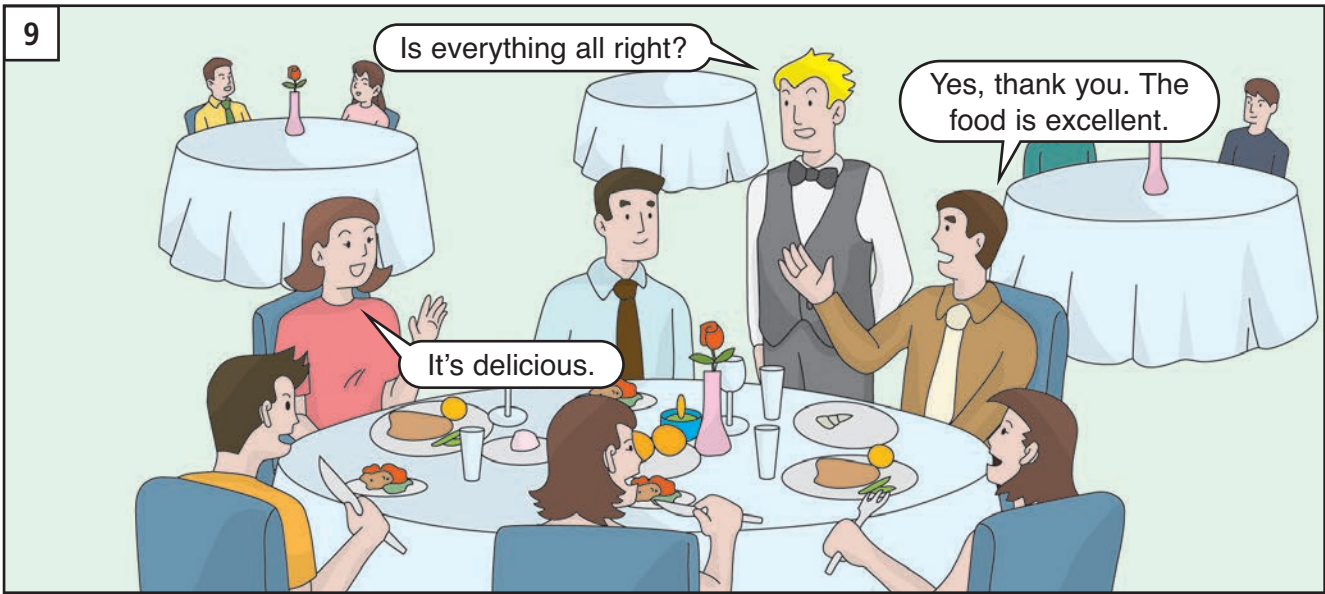

10

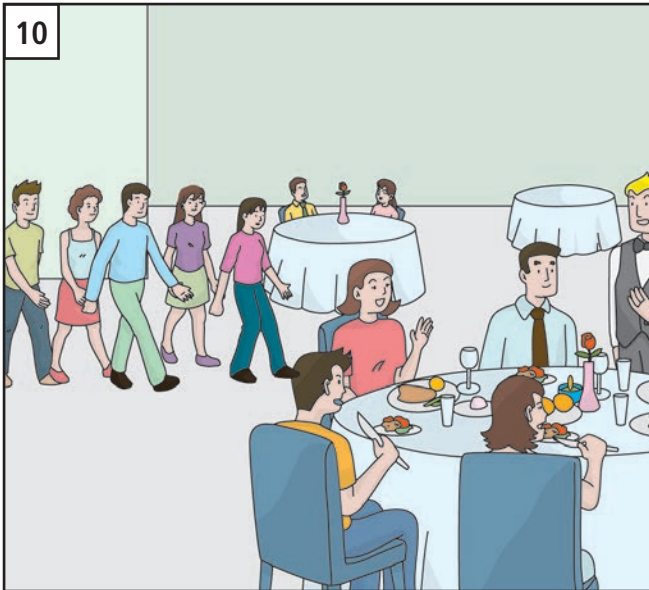

11

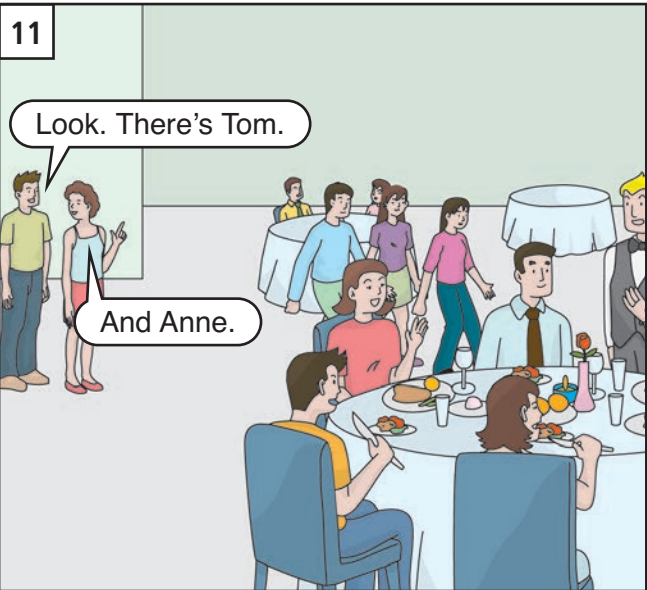

12

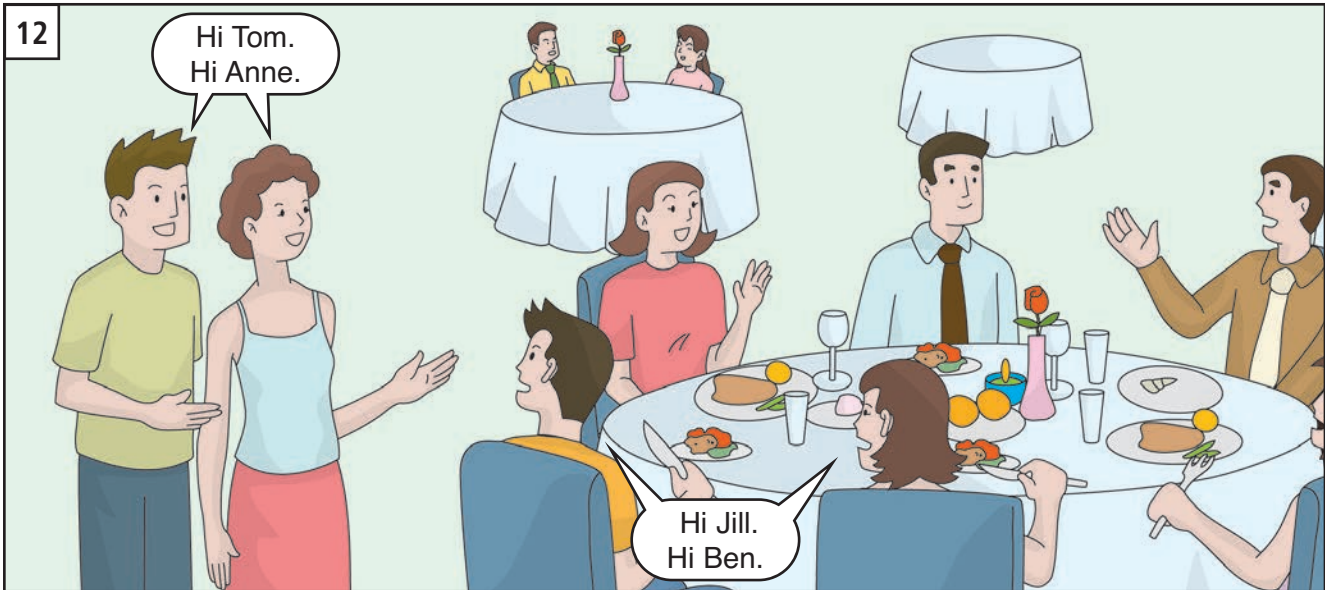

# UNIT 18: If I won, I'd buy a new car.

always  
often  
sometimes  
rarely  
never

as ... as

empty  
full

can't

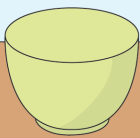

a bowl

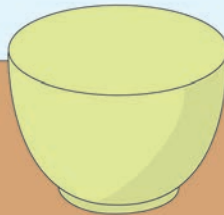

The bowl is empty.



The bowl is full.



a boy



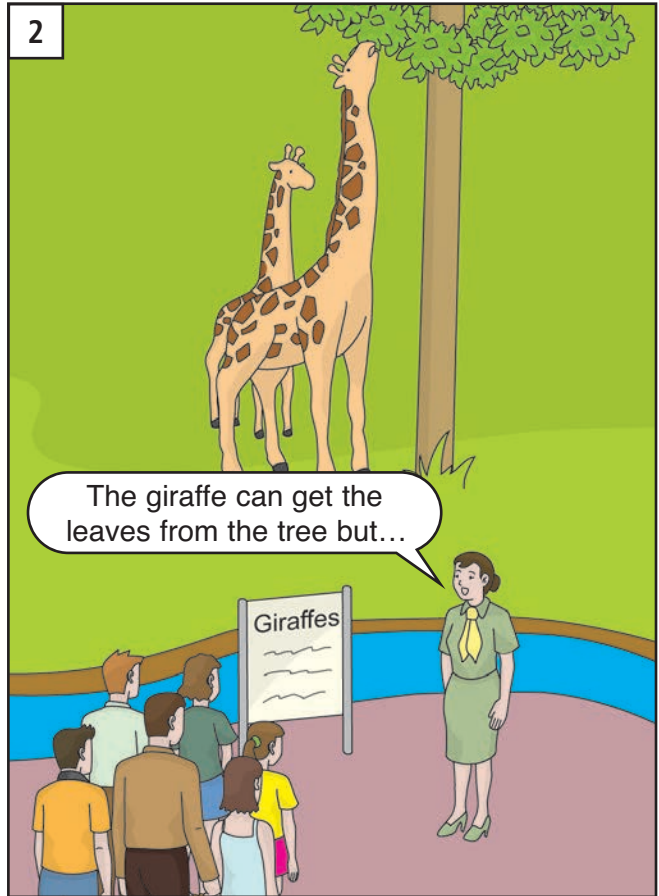

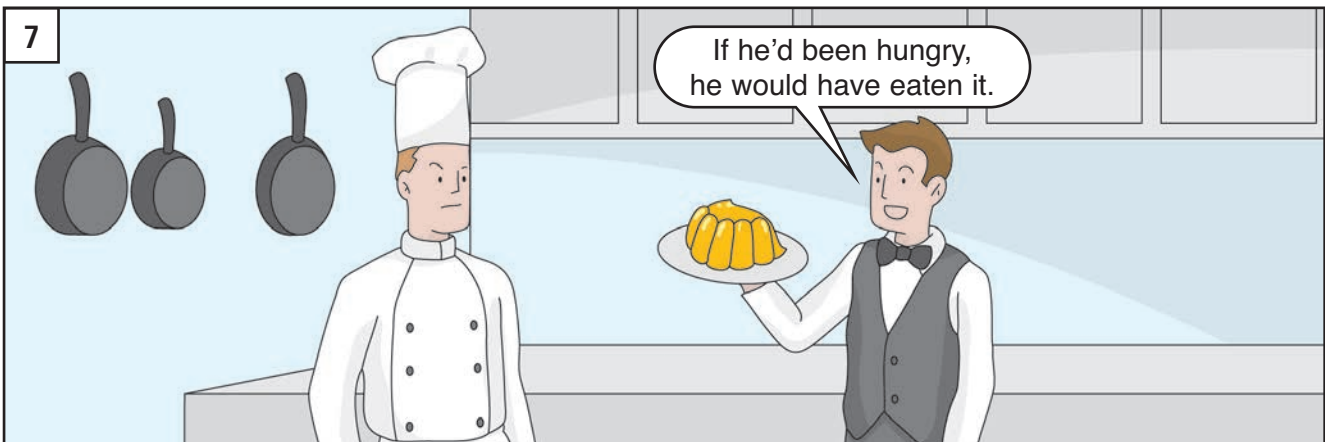
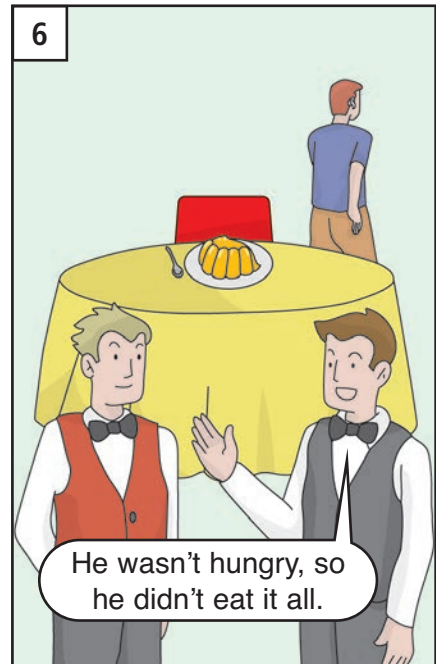
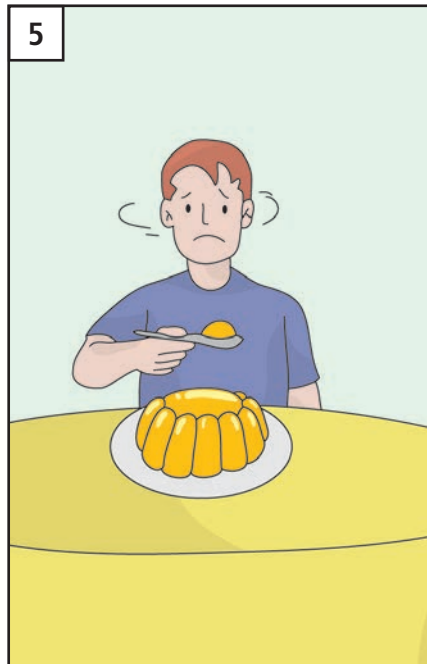
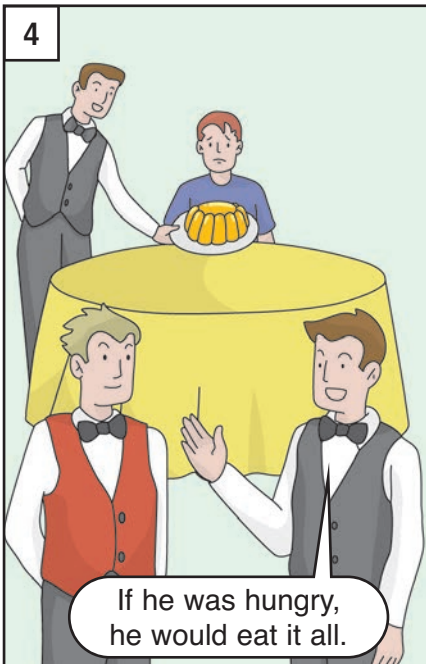
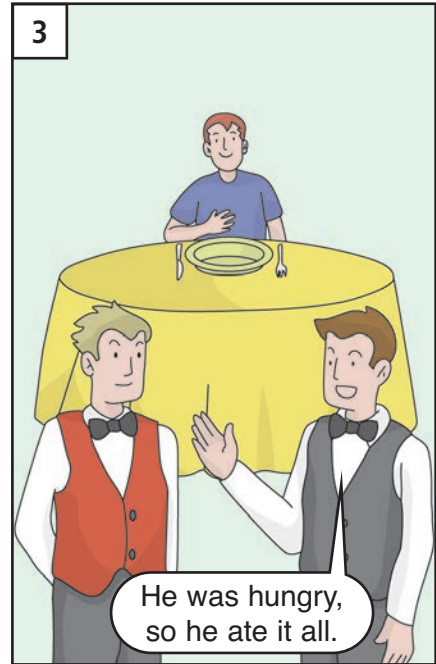
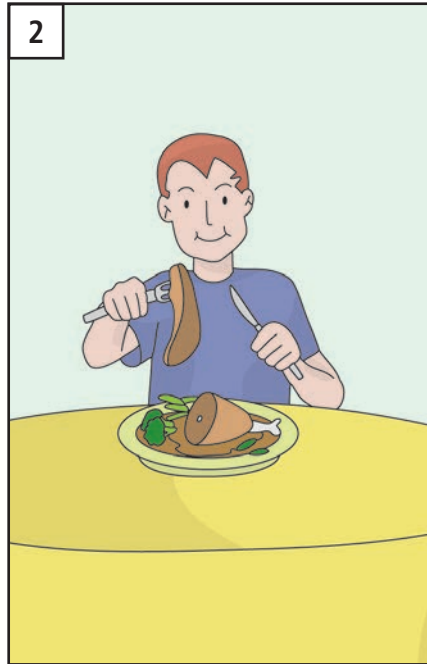
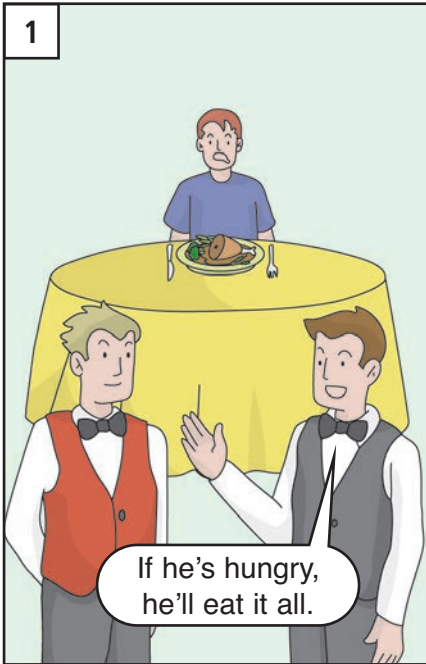

If I won, I'd buy a new car.

1

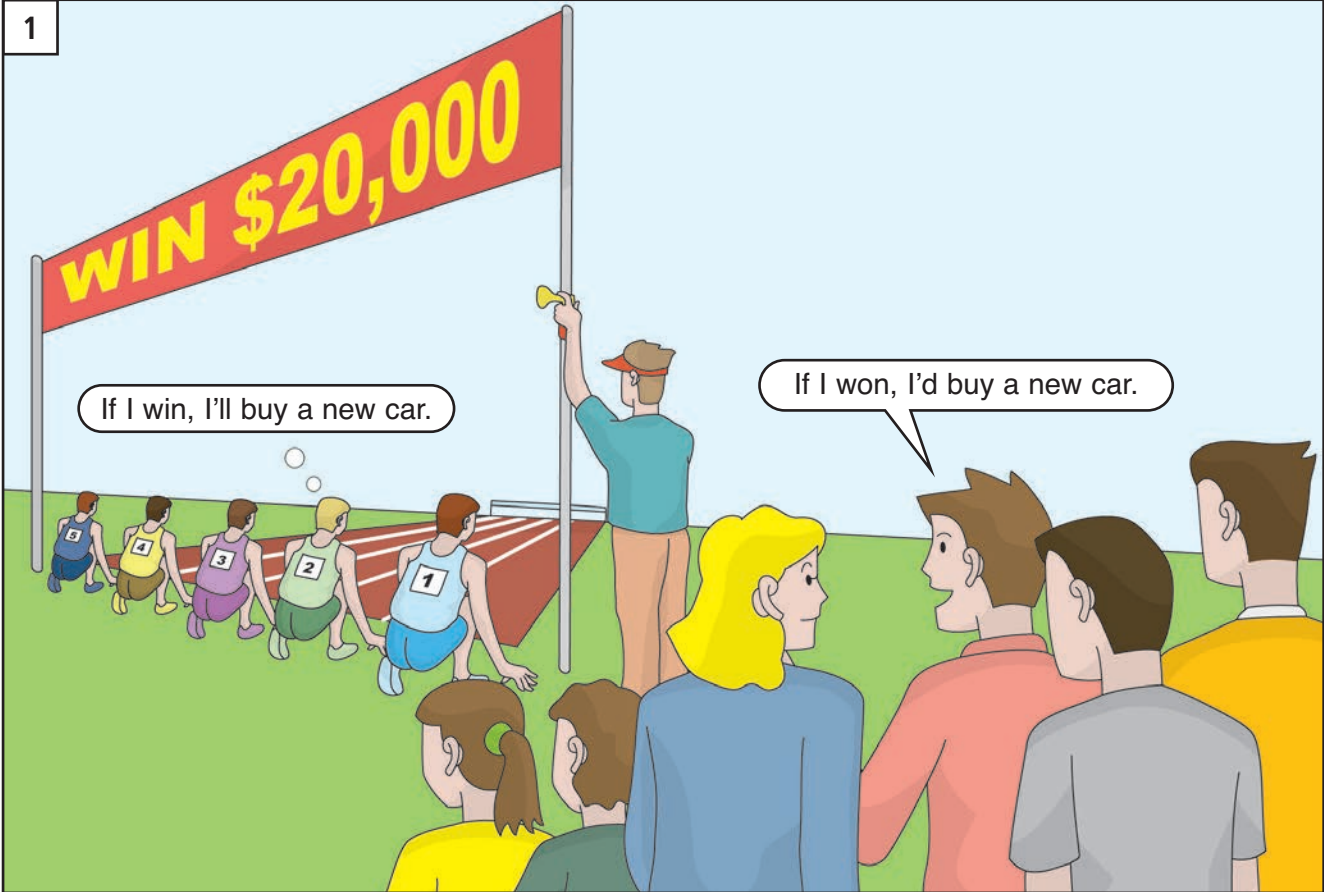

2

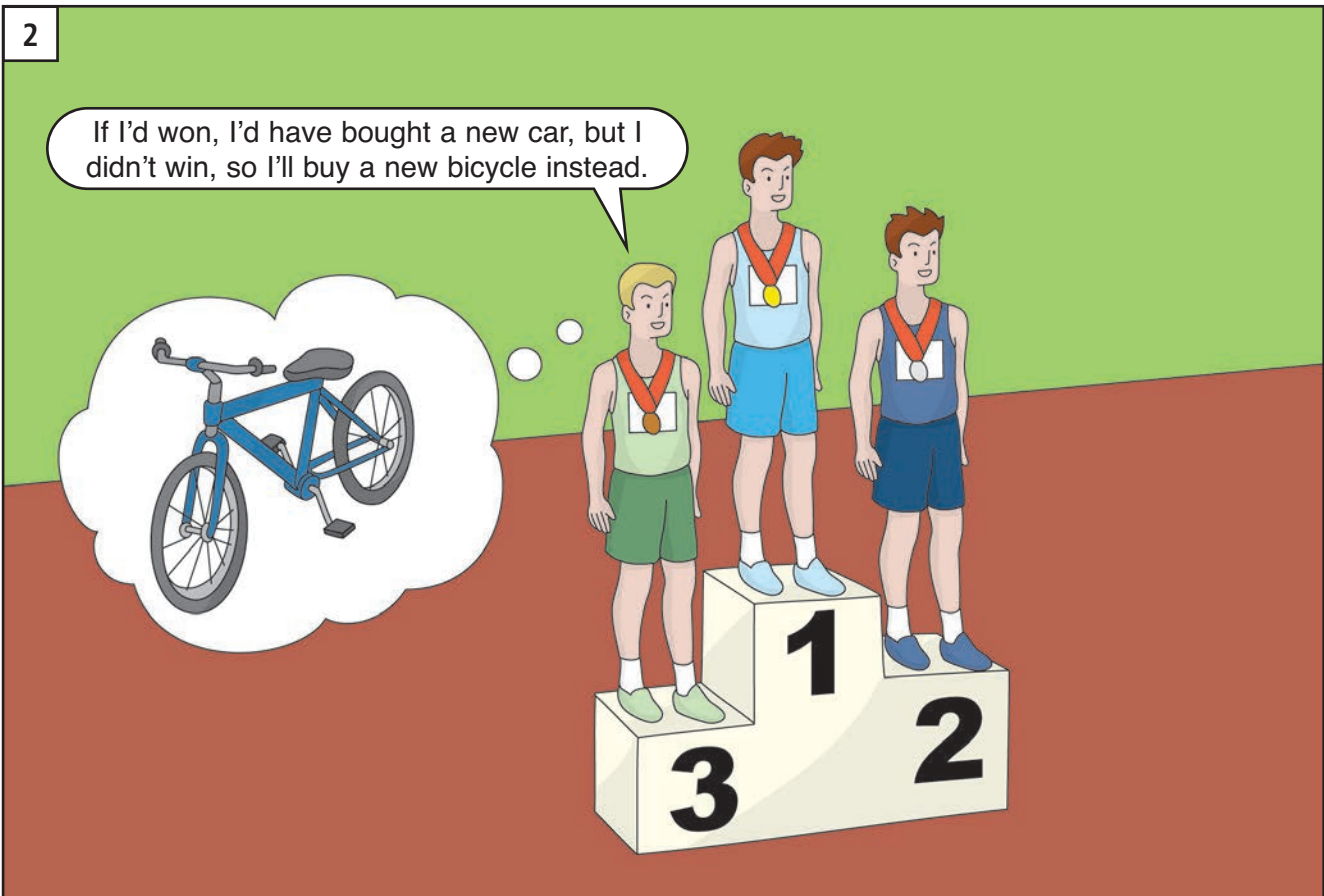

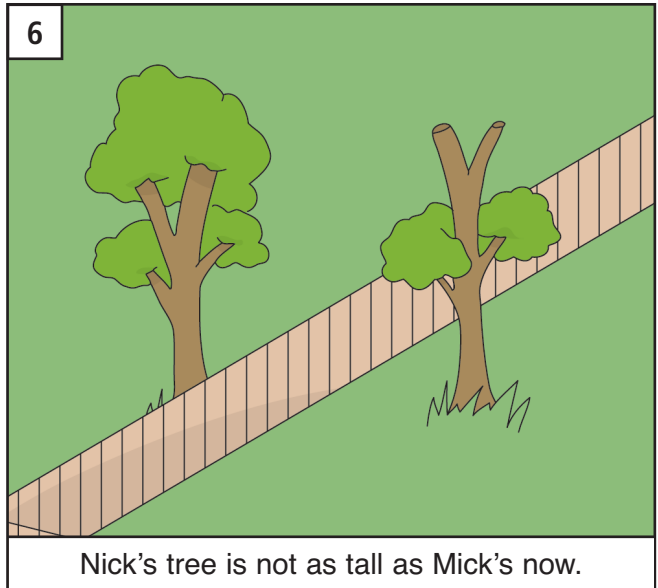
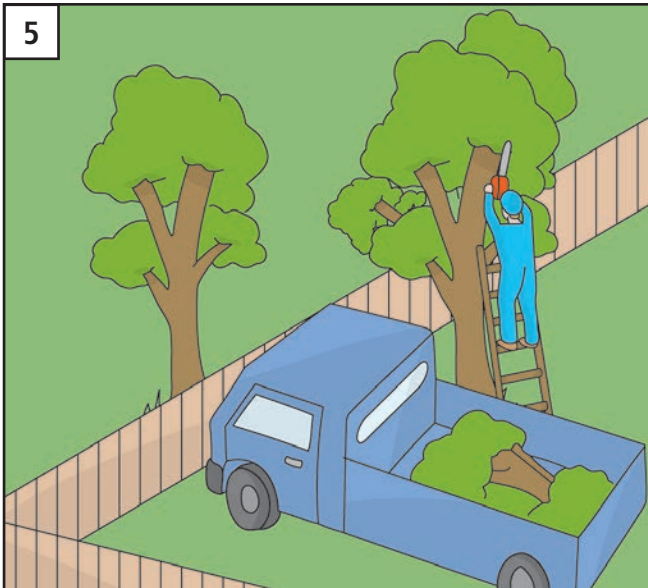
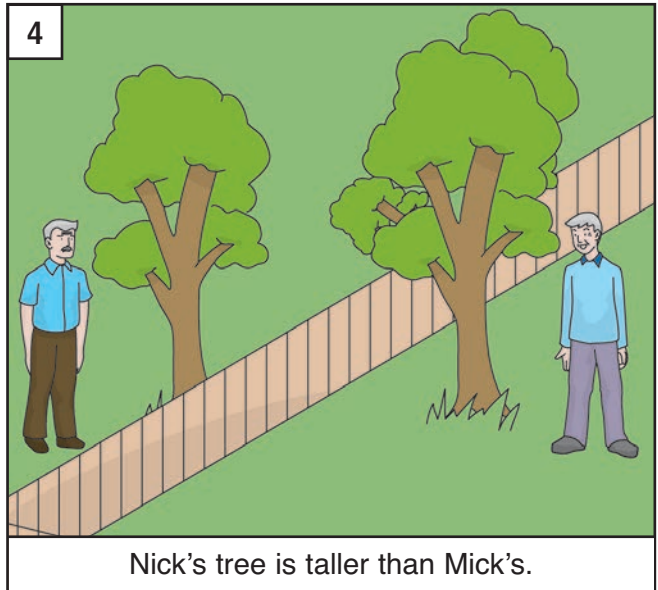
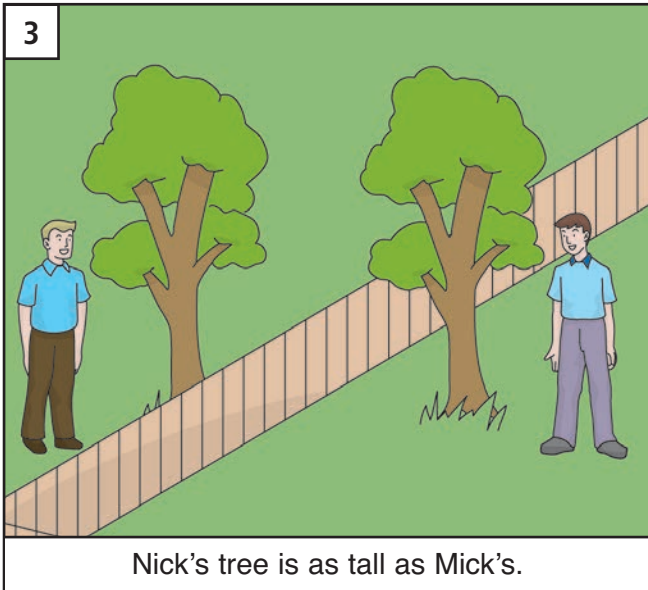
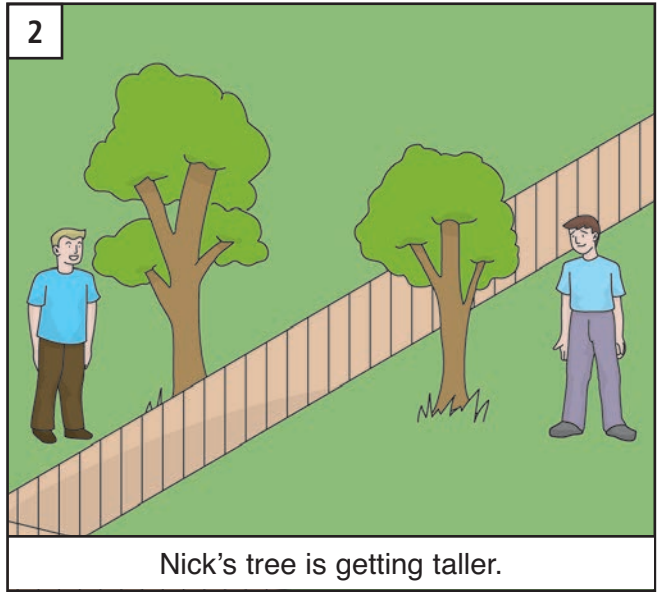
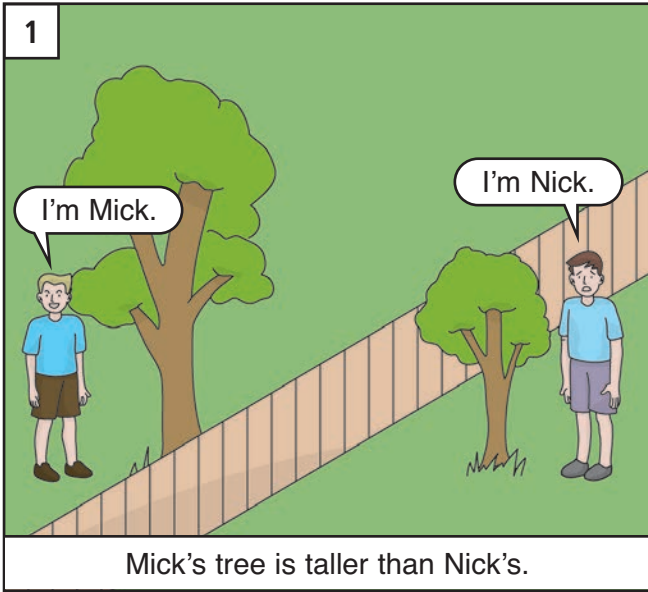

1 I always win.

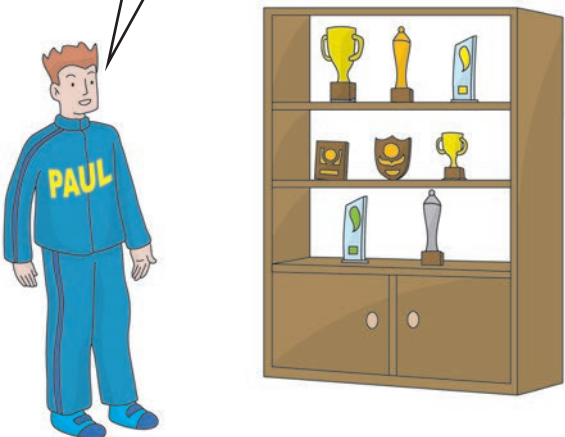

If Paul wins again, he'll get another trophy.

Panel 1: A man named Paul in a blue tracksuit stands next to a brown trophy cabinet. The cabinet is filled with various trophies on its shelves. Paul's speech bubble says "I always win."

2 I often win.



If Linda always won, she'd have as many trophies as Paul.

Panel 2: A woman named Linda in a pink tracksuit stands next to a brown trophy cabinet. The cabinet is filled with various trophies on its shelves. Linda's speech bubble says "I often win."

3 I sometimes win.



If Tex won again, he'd get another trophy.

Panel 3: A man named Tex in a green tracksuit stands next to a brown trophy cabinet. The cabinet has a few trophies on its shelves. Tex's speech bubble says "I sometimes win."

4 I rarely win.

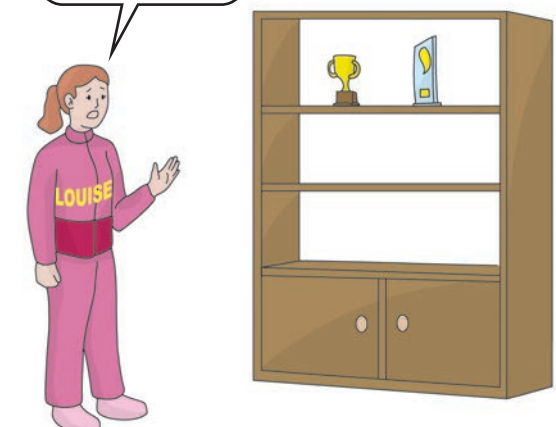

If Louise won again, she'd be very happy.

Panel 4: A woman named Louise in a pink tracksuit stands next to a brown trophy cabinet. The cabinet has a few trophies on its shelves. Louise's speech bubble says "I rarely win."

5 I never win.



If Phil won a race, he'd get his first trophy.

Panel 5: A man named Phil in a green tracksuit stands next to an empty brown trophy cabinet. Phil's speech bubble says "I never win."

6 I never won.

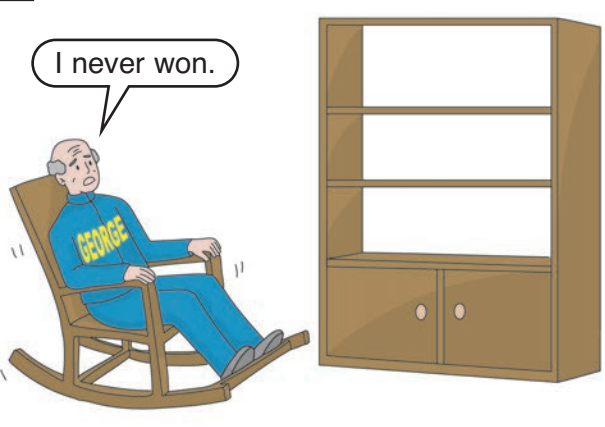

If George had won some races, he'd have some trophies.

Panel 6: An elderly man named George in a blue tracksuit sits in a rocking chair next to an empty brown trophy cabinet. George's speech bubble says "I never won."

# The Bensons

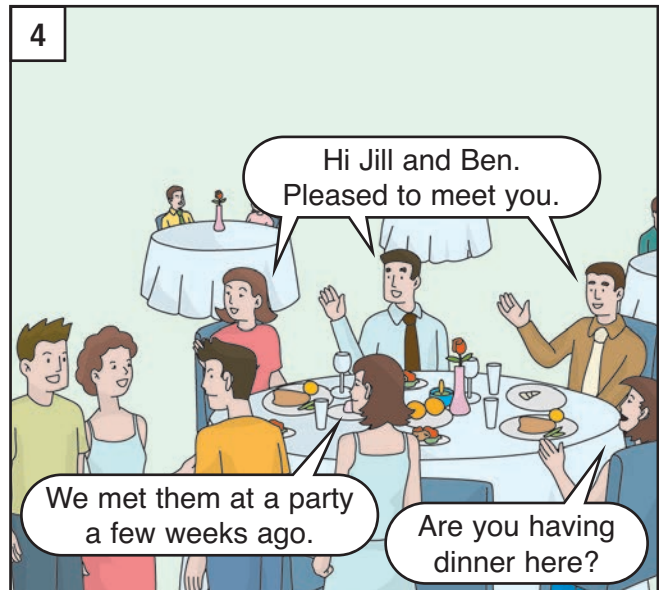
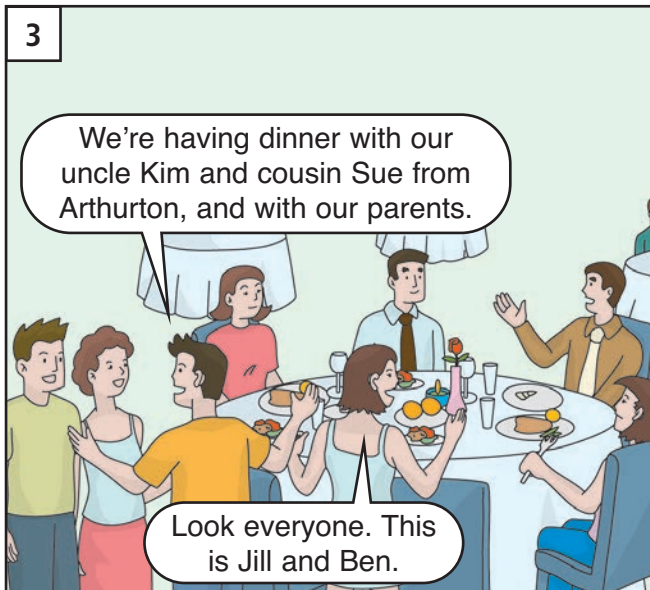
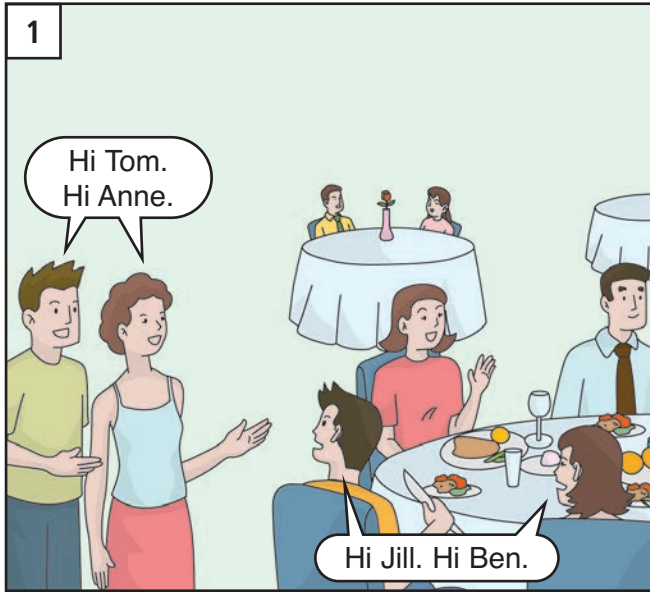

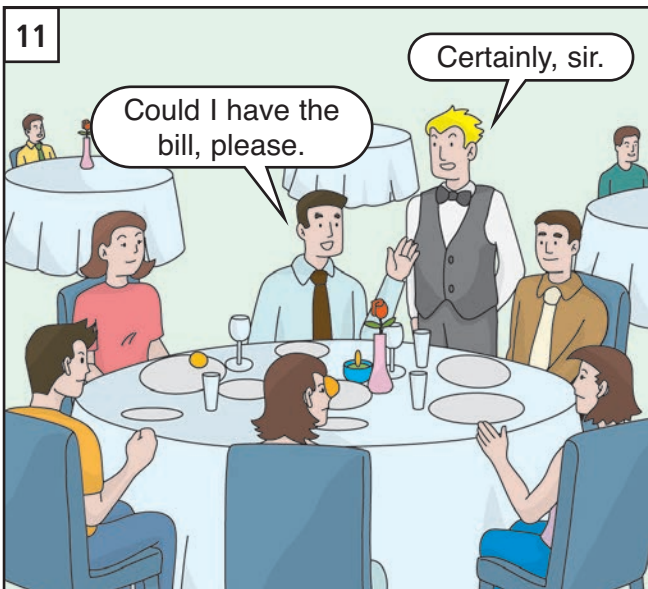
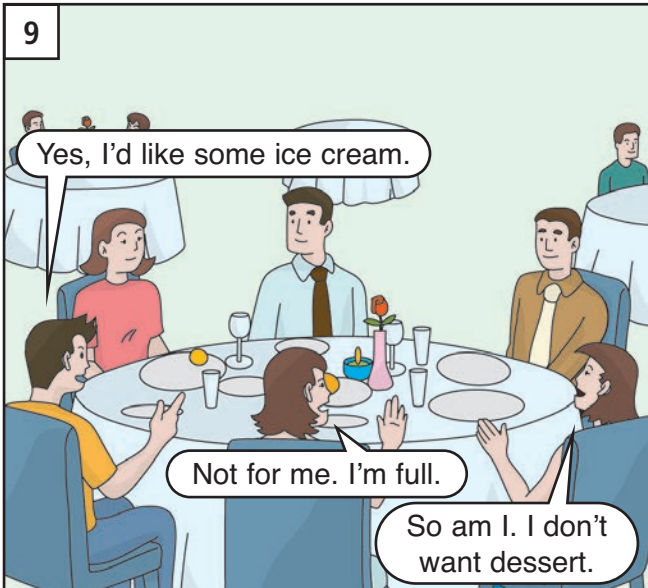
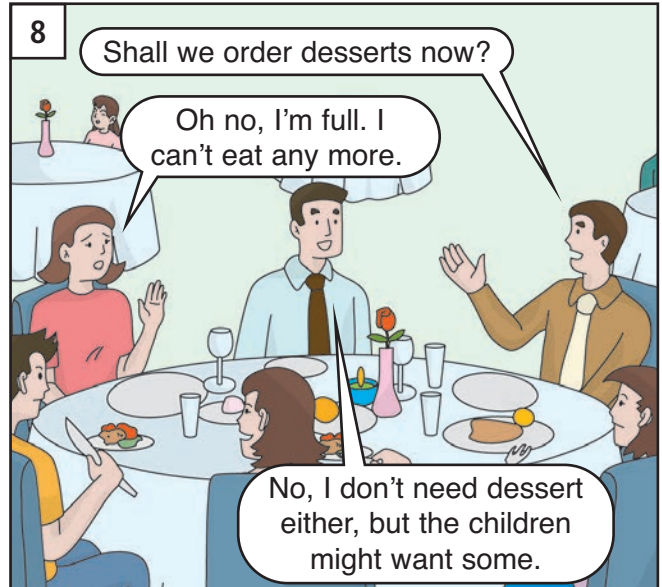
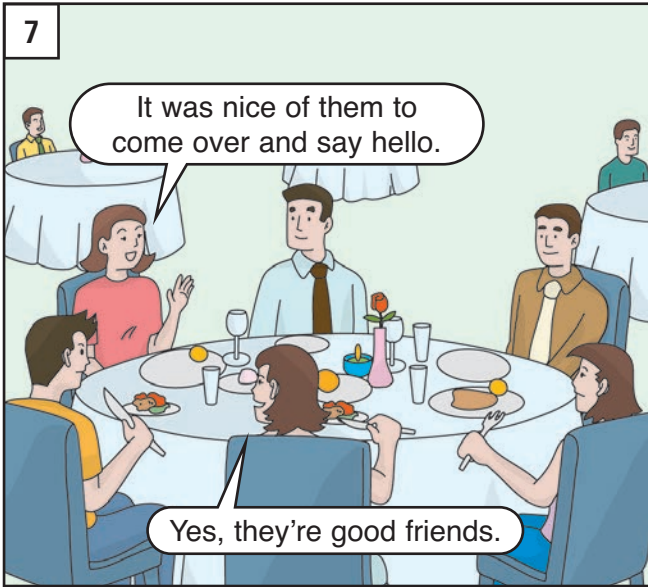

## UNIT 19: I wish I could play the piano.

immediately  
as soon as possible

job advertisement  
interview  
apply  
accept

change  
go out

congratulations  
celebrate  
well done

team

report







piano  
violin  
pianist  
violinist

good luck  
bad luck  
lottery

just a moment

badly

wish

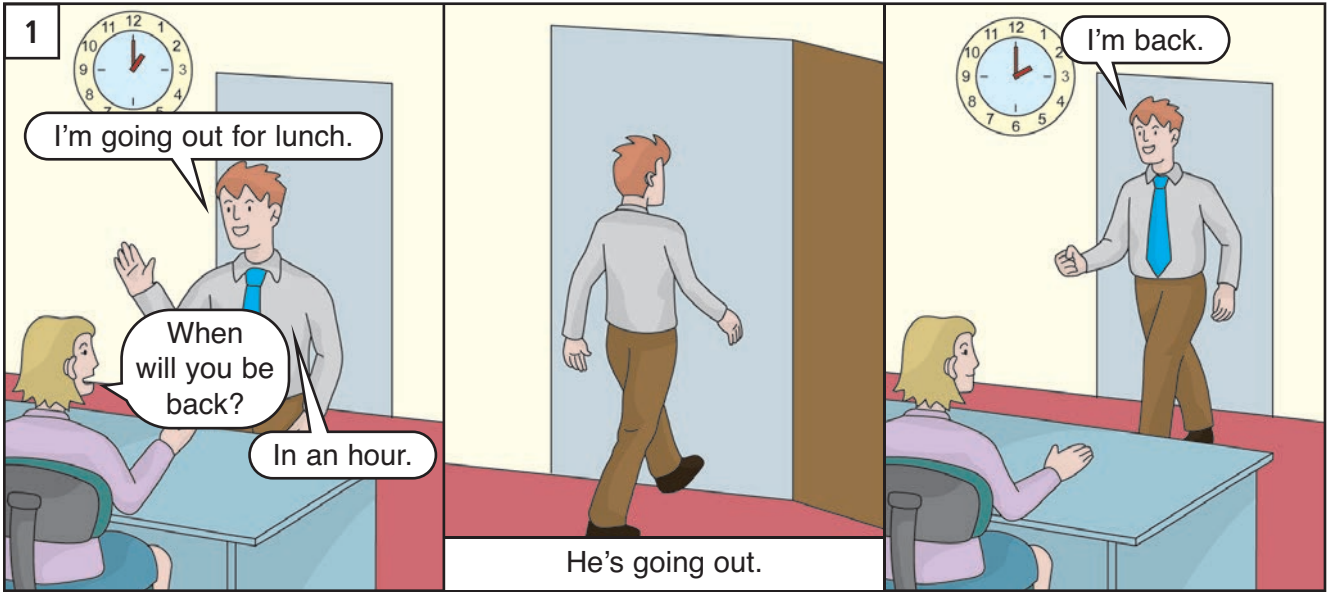

<p>1</p> 		
<p>Rory saw an interesting job advertisement.</p>	<p>He applied for the job.</p>	<p>He went to the interview.</p>
<p>2</p> <p>He got the job.</p> <p>When can you start?</p>  <p>I can start next week.</p>	<p>I got the job.</p> 	<p>Congratulations. Well done!</p> 
<p>He accepted the job.</p>	<p>He told his wife.</p>	<p>He had a party to celebrate his new job.</p>

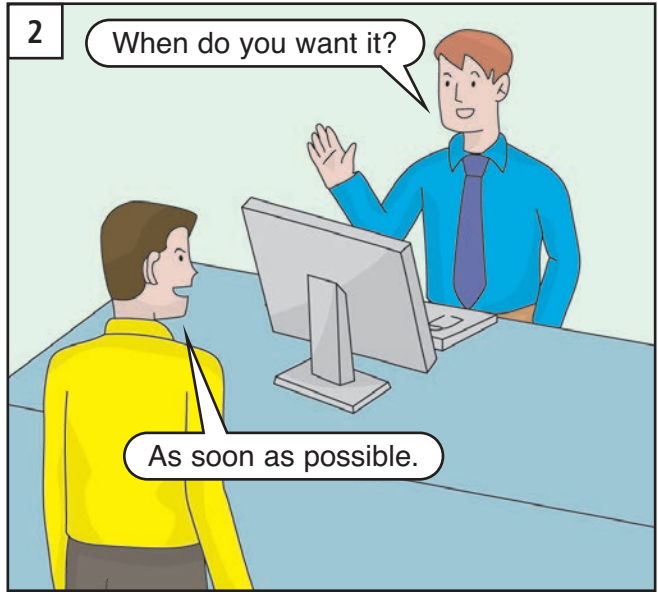
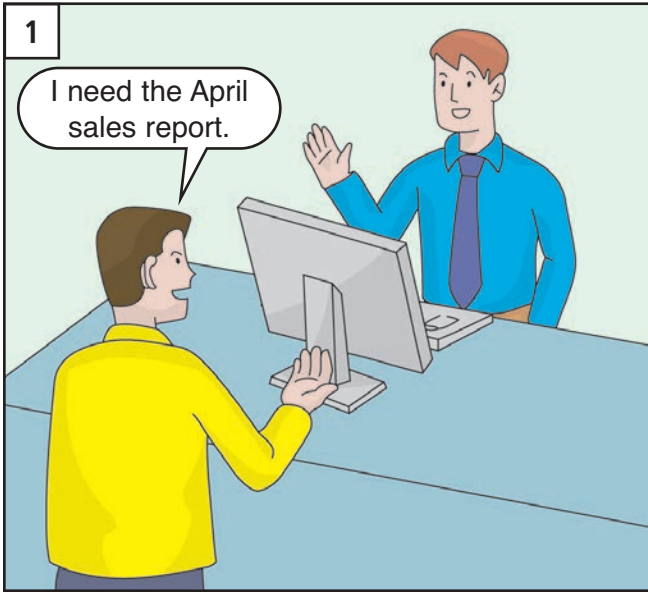

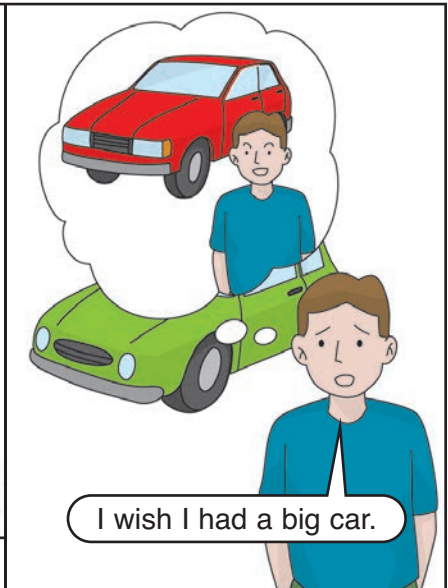
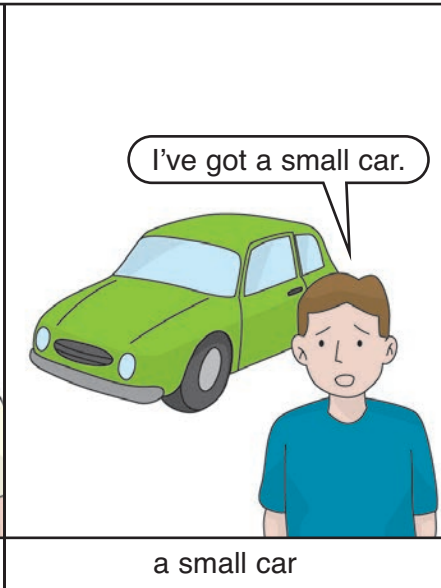
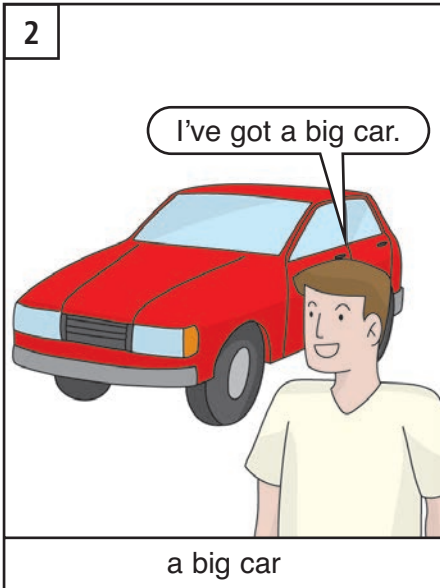

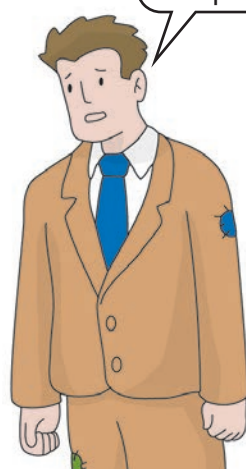
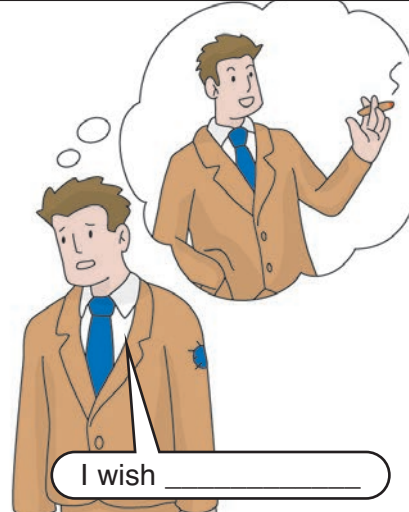











<p>1</p>  <p>I'm rich.</p>	 <p>I'm poor.</p>	 <p>I wish _____</p>
<p>a rich businessman</p>	<p>a poor businessman</p>	

<p>2</p>  <p>I've got a big house.</p>	 <p>I've got a small house.</p>	 <p>I wish _____</p>
<p>a big house</p>	<p>a small house</p>	

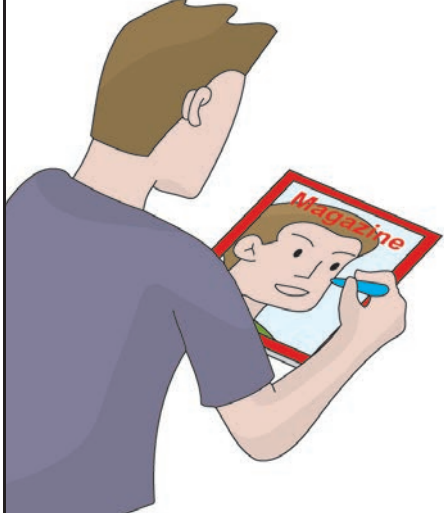
<p>3</p>  <p>I play the violin well.</p>	 <p>I play the violin badly.</p>	 <p>I wish _____</p>
<p>a good violinist</p>	<p>a bad violinist</p>	

1 		
before	change	after

2 		
before	change	after

3 		
before	change	after

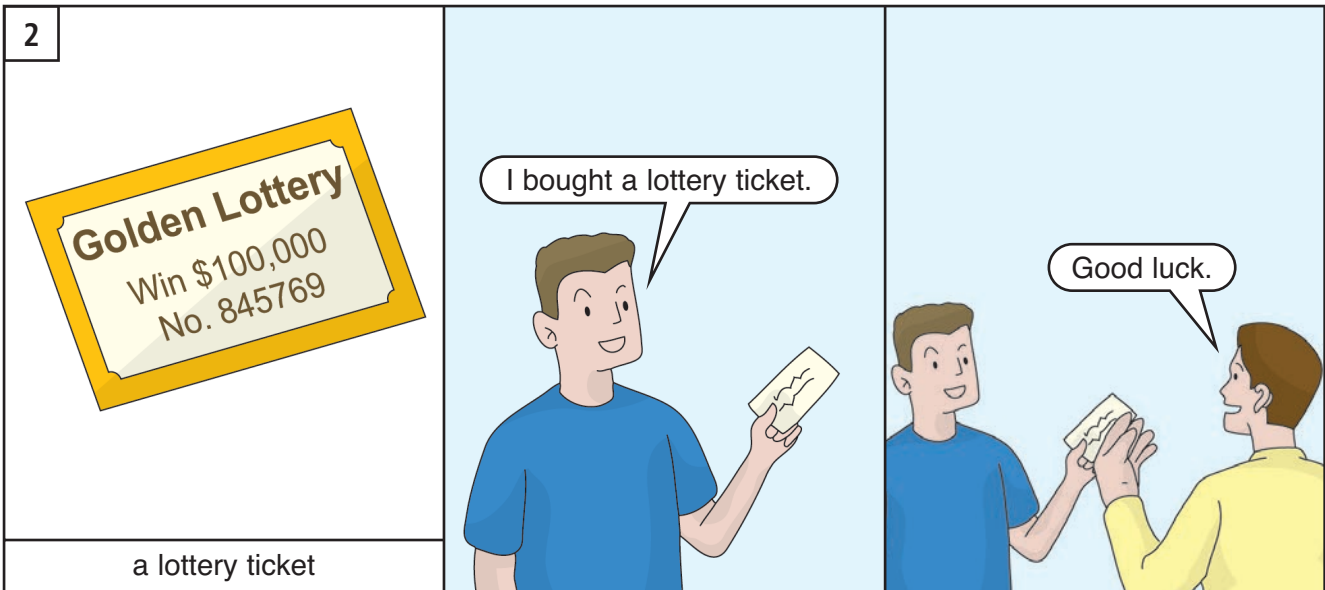
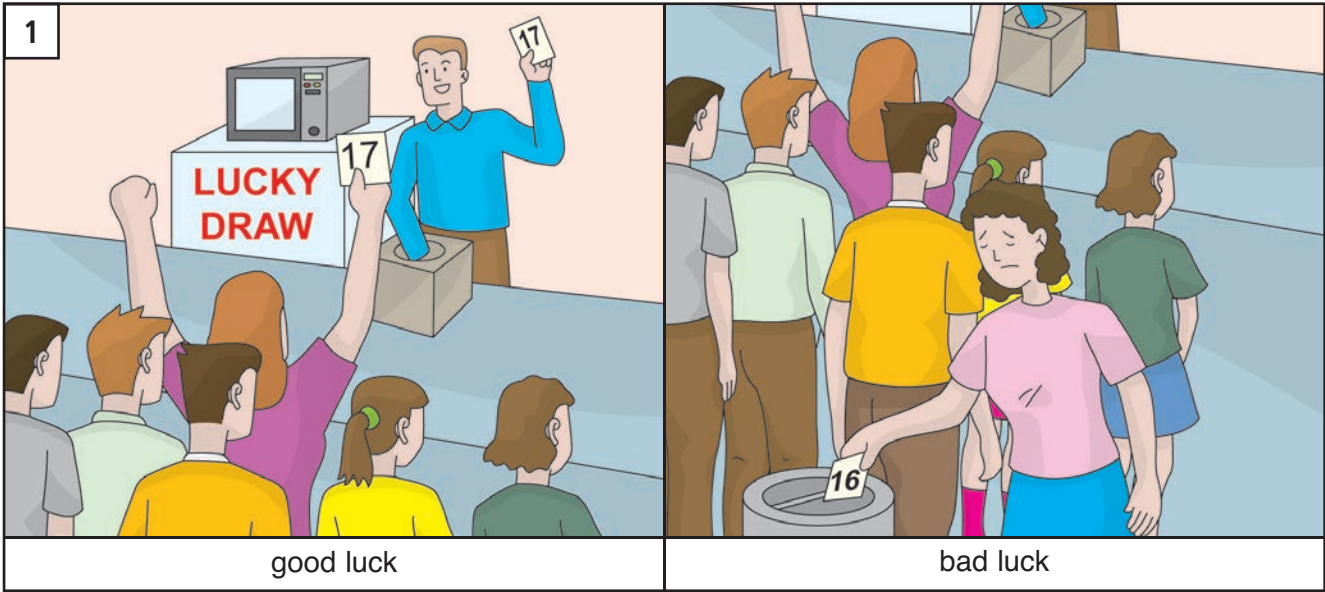

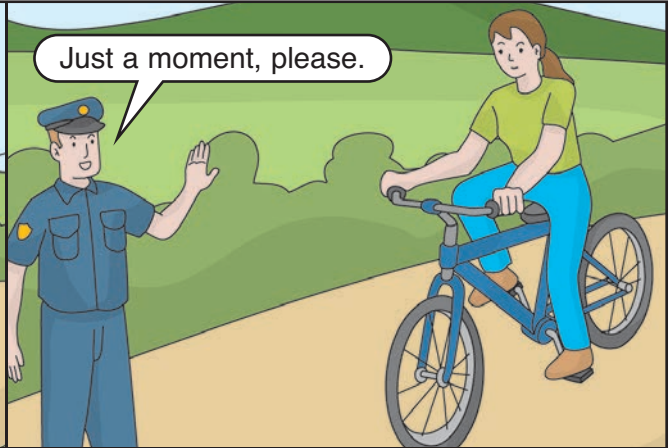
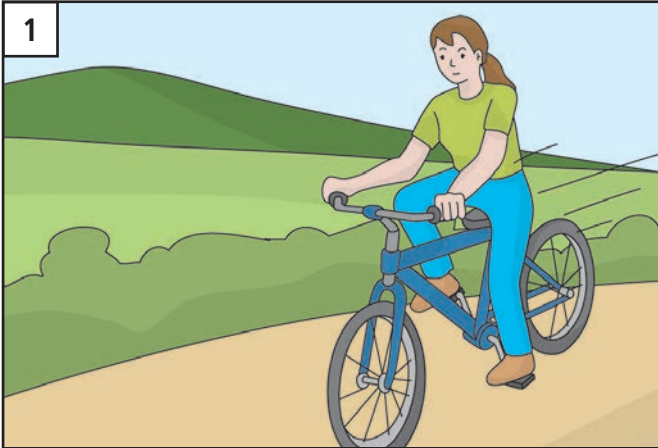



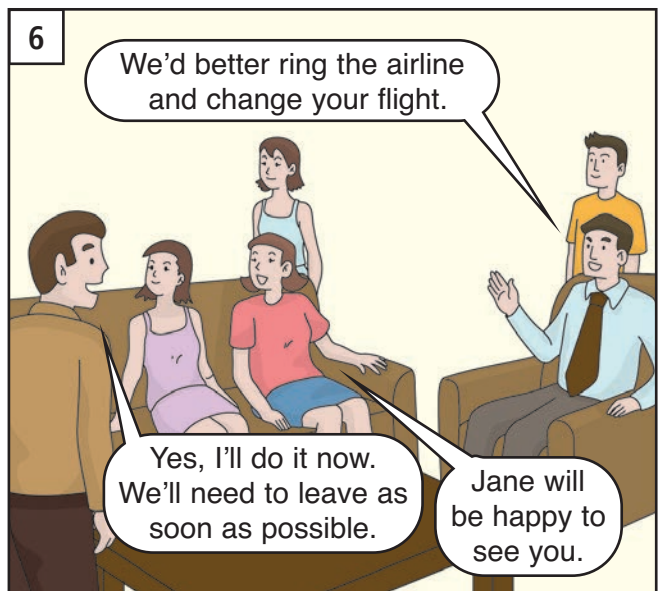
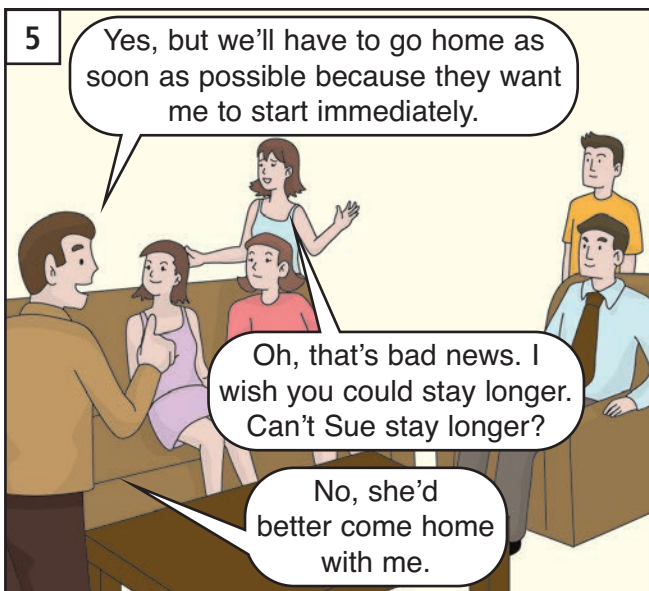
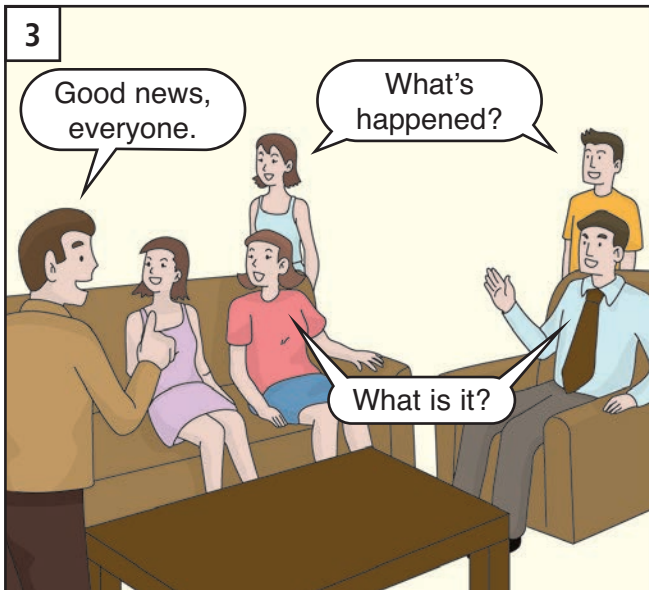
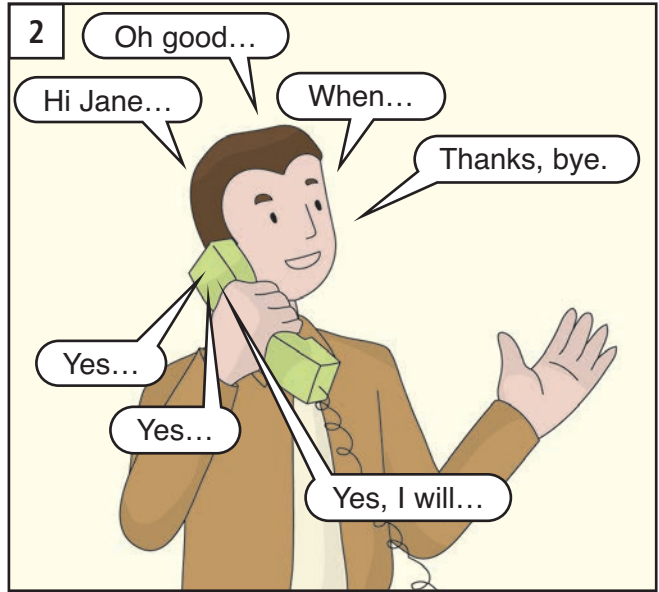
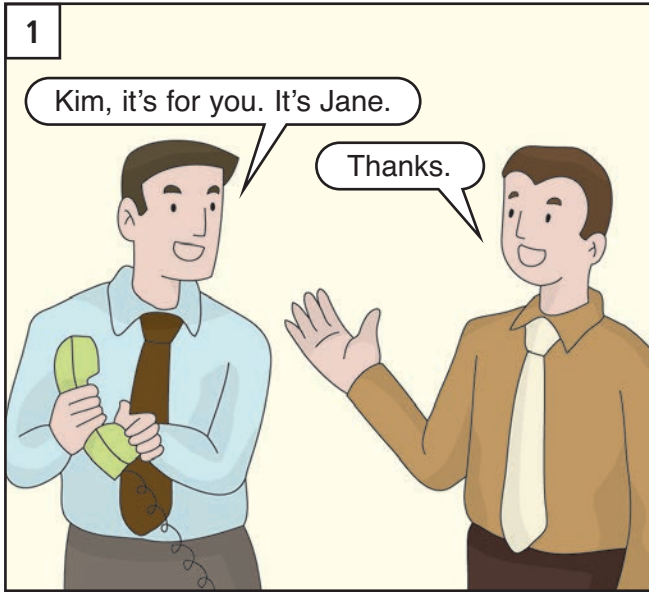

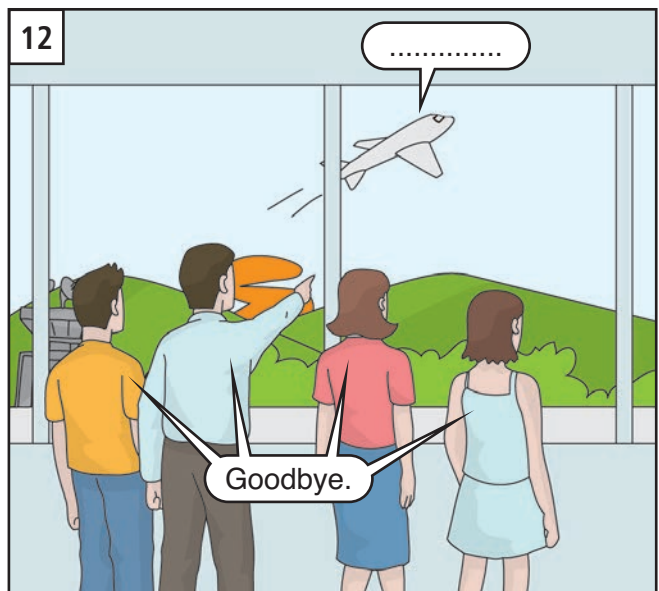
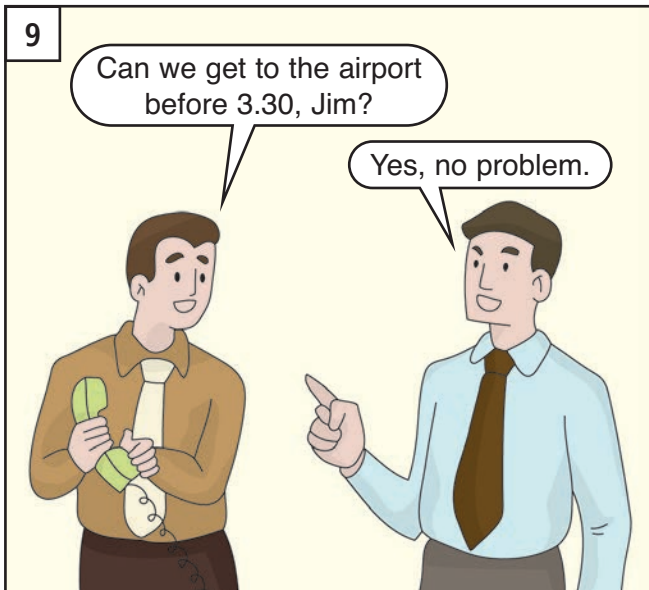

# The Bensons

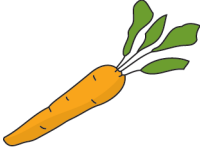
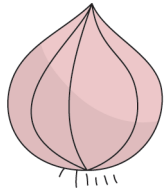

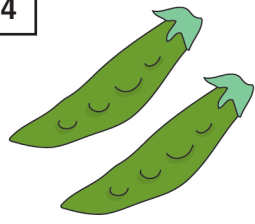
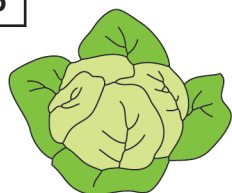
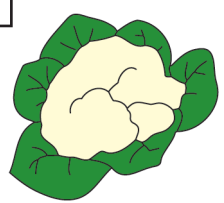
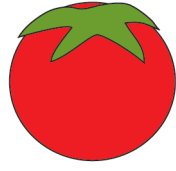
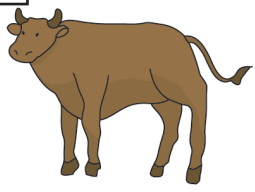
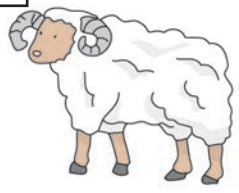
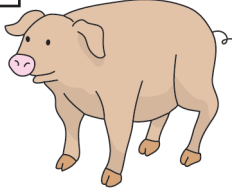
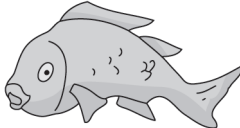

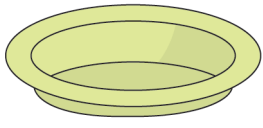
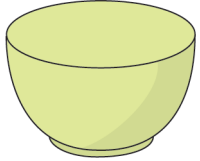
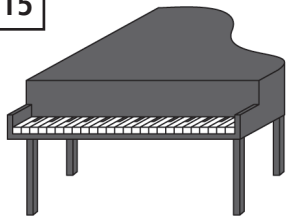
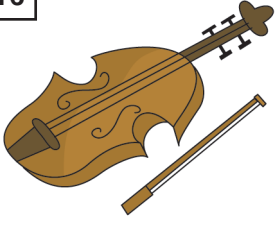
# UNIT 20: Revision and Extension

<p>1</p>  <p>carrot</p> <p>.....</p>	<p>2</p>  <p>.....</p>	<p>3</p>  <p>.....</p>	<p>4</p>  <p>.....</p>
<p>5</p>  <p>.....</p>	<p>6</p>  <p>.....</p>	<p>7</p>  <p>.....</p>	<p>8</p>  <p>.....</p>
<p>9</p>  <p>.....</p>	<p>10</p>  <p>.....</p>	<p>11</p>  <p>.....</p>	<p>12</p>  <p>.....</p>
<p>13</p>  <p>.....</p>	<p>14</p>  <p>.....</p>	<p>15</p>  <p>.....</p>	<p>16</p>  <p>.....</p>
<p>17</p>  <p>.....</p>	<p>18</p>  <p>.....</p>		

**A**

- |                                |                                |
|--------------------------------|--------------------------------|
| 1. Is your shirt too big?      | a. That way.                   |
| 2. I'll have a coffee, thanks. | b. Yes, but they're too short. |
| 3. Which way to the bank?      | c. No, it's just right.        |
| 4. Your jeans look good.       | d. That's a dollar fifty.      |

**B**

- |                                  |                      |
|----------------------------------|----------------------|
| 1. He likes going to the movies. | a. So will I.        |
| 2. I don't like cold weather.    | b. So does she.      |
| 3. They're not swimming today.   | c. Neither will I.   |
| 4. She can't speak French.       | d. Neither can they. |
| 5. I'll have some fish.          | e. Neither do I.     |
| 6. I won't have an entrée.       | f. Neither are we.   |

**C**

- |                          |                                  |
|--------------------------|----------------------------------|
| 1. I'm hungry.           | a. I'd like some too.            |
| 2. I'm thirsty.          | b. As soon as possible.          |
| 3. I'd like a hamburger. | c. You'd better eat something.   |
| 4. I'd like some soup.   | d. I'd like one too.             |
| 5. When should we leave? | e. You'd better drink something. |

**D**

- |  |                     |
|--|---------------------|
| 1. When will you be back?              | a. Bad luck.        |
| 2. Can I try them on?                  | b. Good luck.       |
| 3. I've lost fifty dollars.            | c. Yes, of course.  |
| 4. My job interview is this afternoon. | d. In five minutes. |

try      think      cost      take      too      reduction      would      for      better

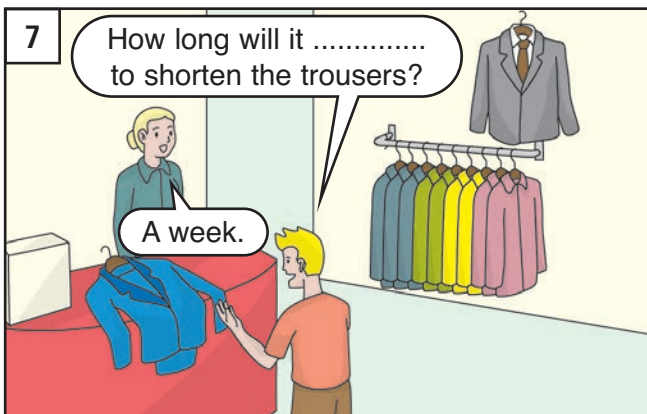
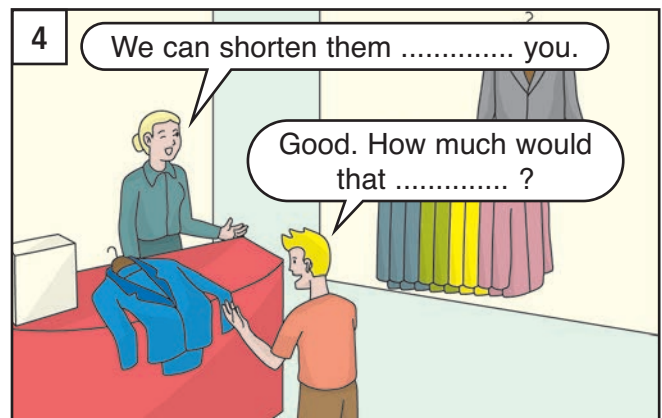
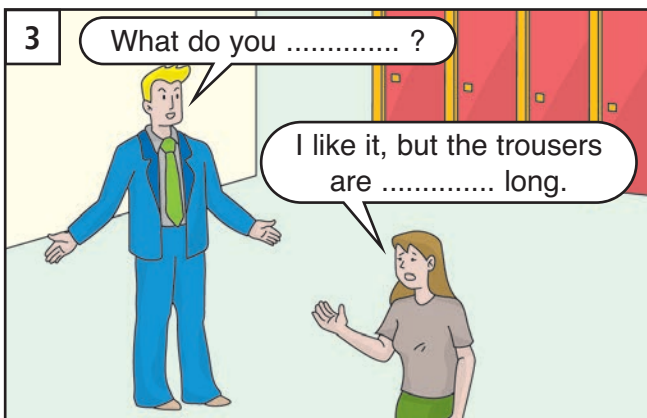

was So full I enough afraid some delicious instead have

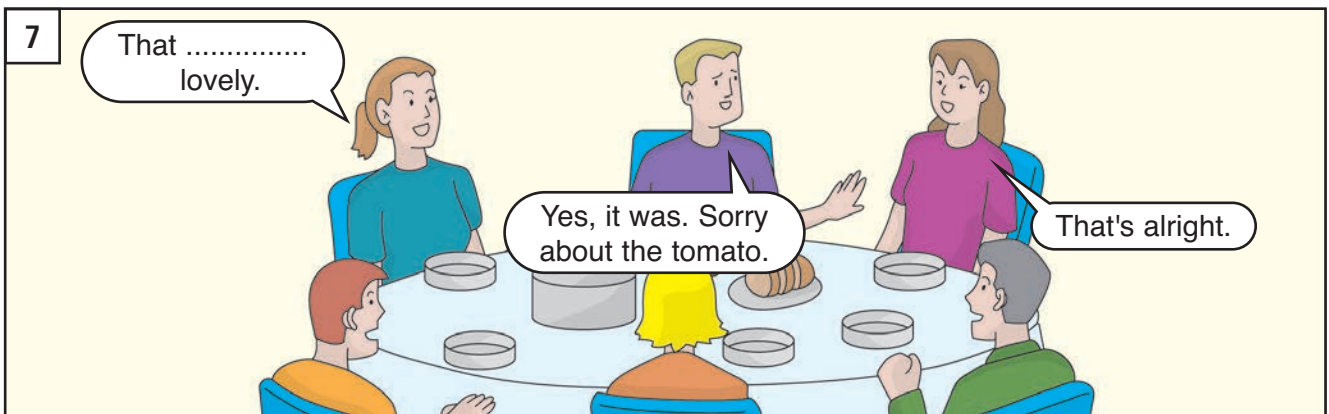
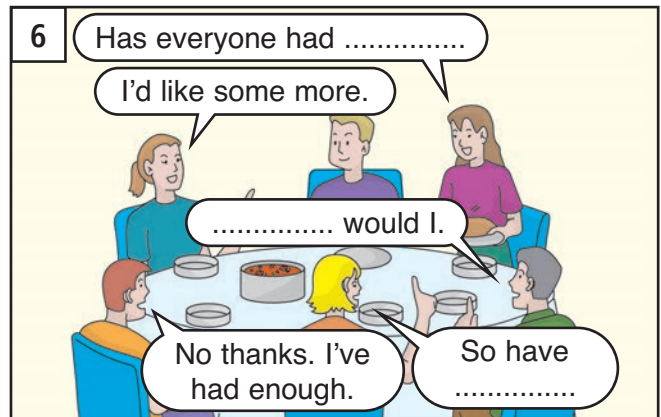
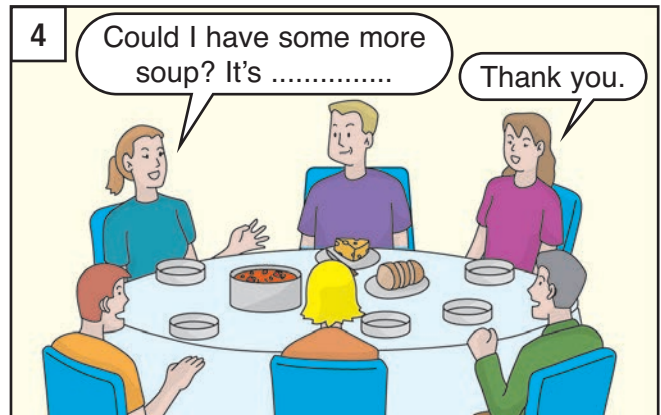
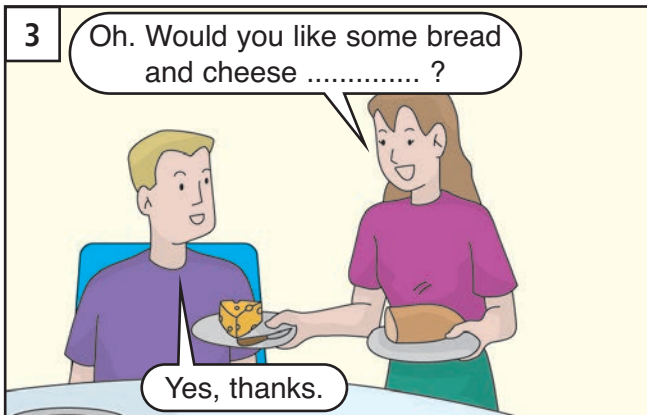
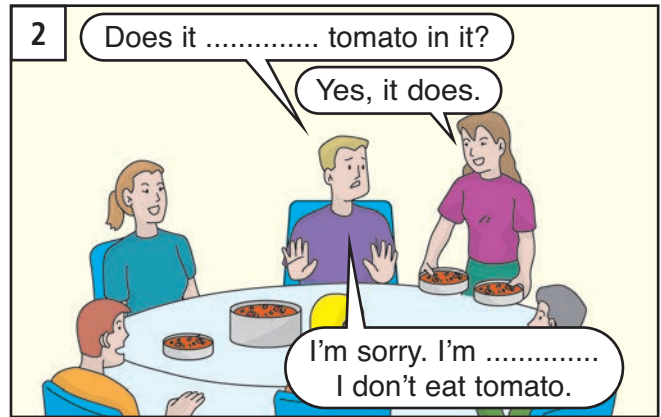
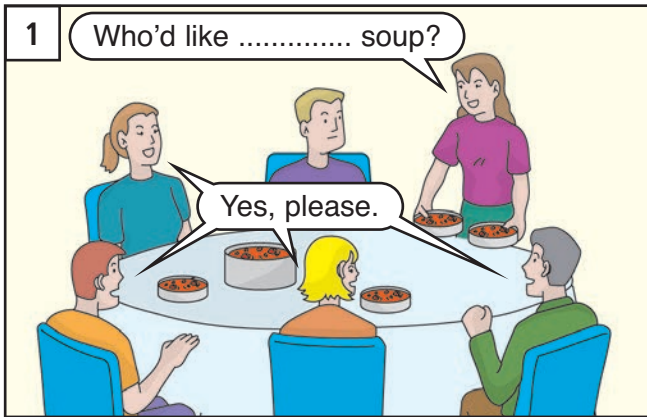

until      day      would      if      appointment      change      next

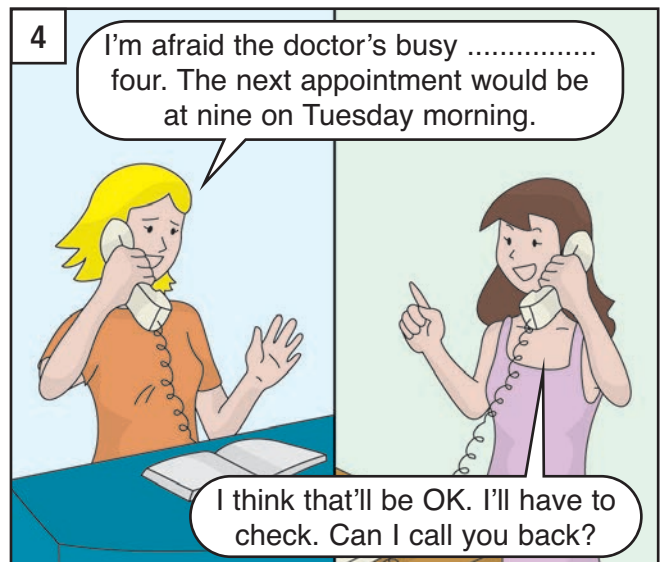
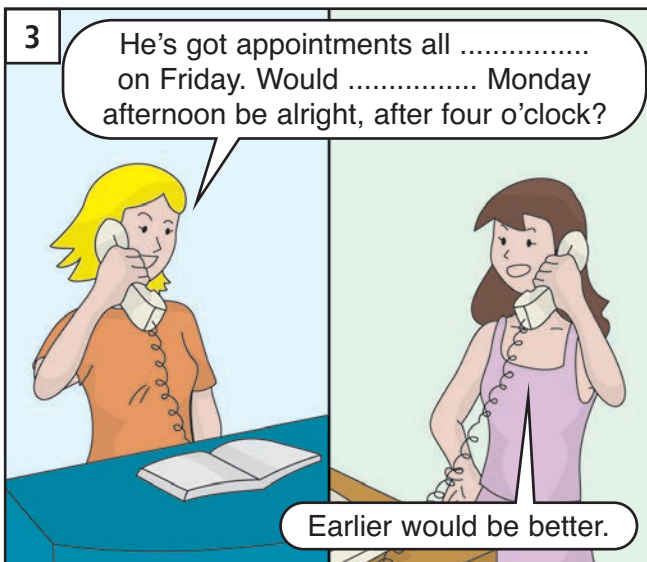
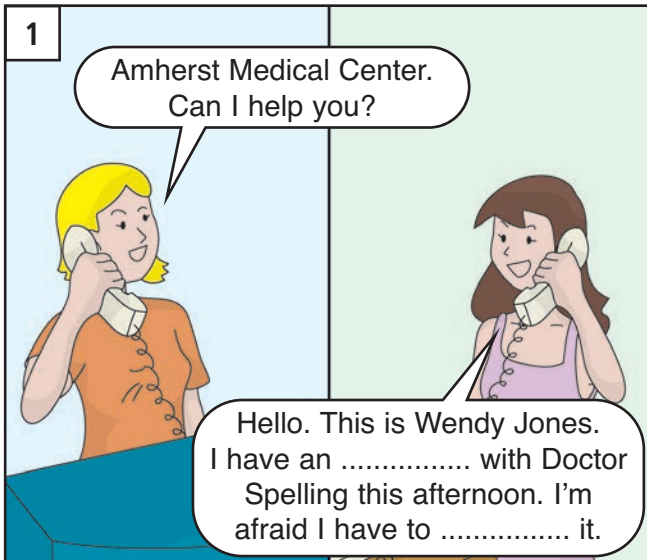

before

again

everything

if

haven't

So

soon

1 HOTEL

It was lovely to meet you. We've really enjoyed it here.

..... have we. It's a pity you can't stay longer.

2 HOTEL

Yes. I hope we'll see you in New York.

Thanks. You've got our address ..... you?

Yes, we have.

3 HOTEL

And ..... you come to Sydney, you can stay with us.

That would be great.

4 HOTEL

We'll have to leave ..... The taxi will be here in a few minutes.

OK. Are you sure we've packed ..... ?

5

Yes. I checked ..... we left the room.

We'd better go. The taxi's arrived.

6

Goodbye. Hope to see you ..... soon.

Goodbye.

UNIT 20



- shoes small these too Are
- right just they're No

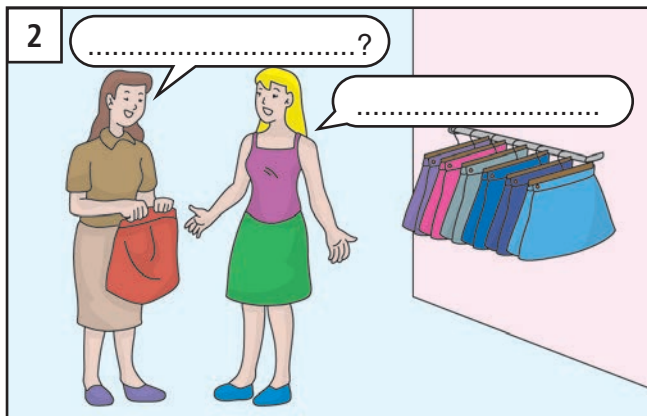

- the long skirt too Is
- it's short too No



- big The jacket's too
- size I'll smaller get a

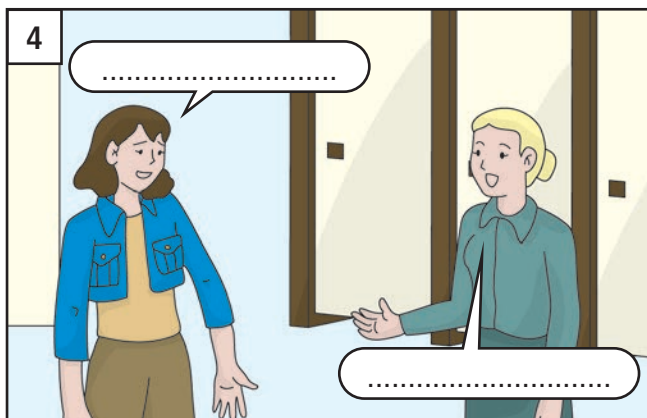

- is This small too
- larger a get I'll size

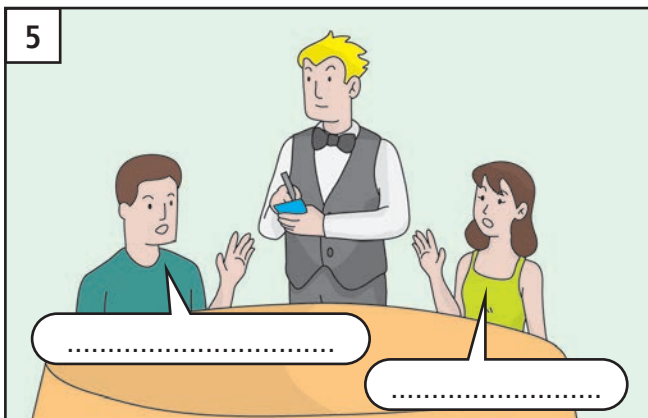

- coffee don't I want
- I Neither do

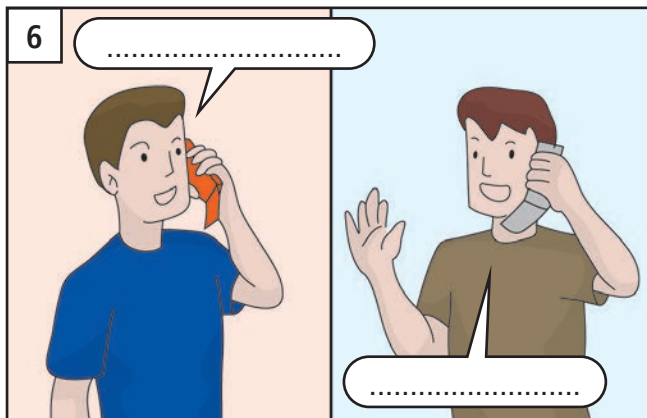

- long I talk can't
- can Neither I

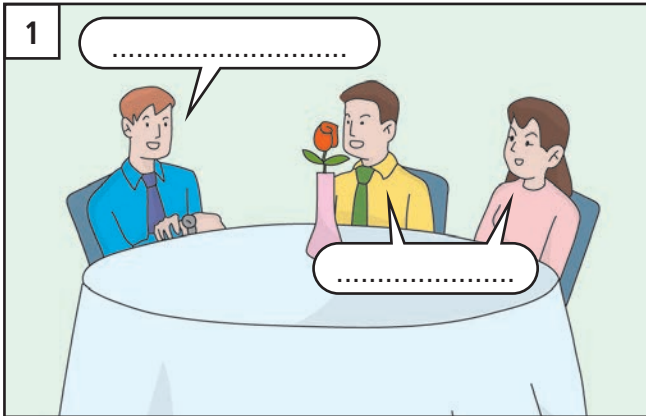

- go to have I soon
- do we So

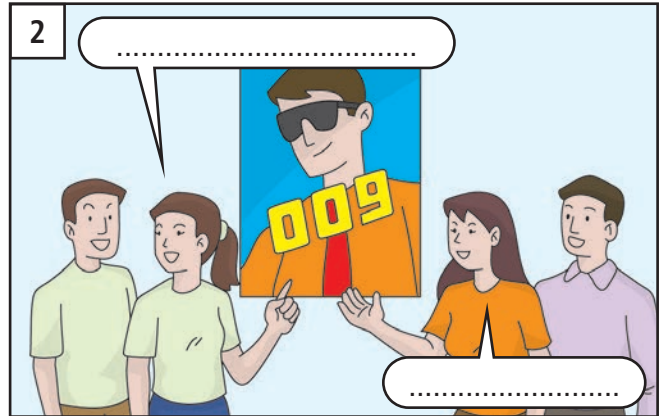

- go We movie that to won't
- we will Neither



- coke I'd a like
- too one like I'd

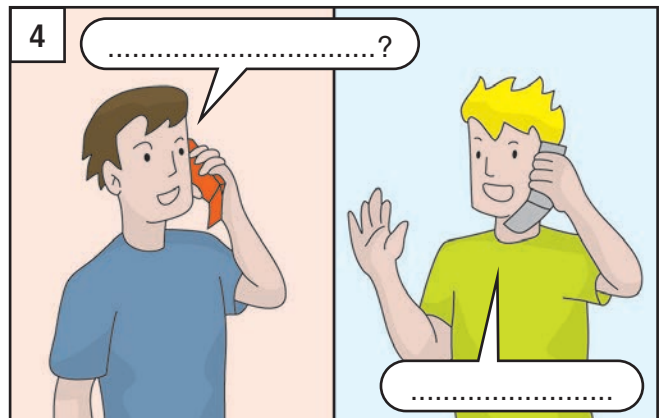

- time party is What the
- thirty Seven



- need you do a When flight
- possible soon As as



- back you When be will
- two hours In

## Answers to Unit 20

### Unit 20, page 178

- |                |           |               |          |            |
|----------------|-----------|---------------|----------|------------|
| 1. carrot      | 2. onion  | 3. beans      | 4. peas  | 5. cabbage |
| 6. cauliflower | 7. tomato | 8. cow        | 9. sheep | 10. pig    |
| 11. fish       | 12. swim  | 13. plate     | 14. bowl | 15. piano  |
| 16. violin     | 17. team  | 18. interview |          |            |

### Unit 20, page 179

- A. 1c 2d 3a 4b      B. 1b 2e 3f 4d 5a 6c      C. 1c 2e 3d 4a 5b      D. 1d 2c 3a 4b

### Unit 20, page 180

1. better      2. try      3. think, too      4. for, cost      5. would      6. reduction      7. take

### Unit 20, page 181

1. some      2. have, afraid      3. instead      4. delicious      5. full      6. enough, So, I      7. was

### Unit 20, page 182

1. appointment, change      2. would      3. day, next      4. until      5. if

### Unit 20, page 183

1. So      2. haven't      3. if      4. soon, everything      5. before      6. again

### Unit 20, page 184

- Are these shoes too small?  
No, they're just right.
- Is the skirt too long?  
No, it's too short.
- The jacket's too big.  
I'll get a smaller size.
- This is too small.  
I'll get a larger size.
- I don't want coffee.  
Neither do I.
- I can't talk for long.  
Neither can I.

### Unit 20, page 185

- I have to go soon.  
So do we.
- We won't go to that movie.  
Neither will we.
- I'd like a coke.  
I'd like one too.
- What time is the party?  
Seven thirty.
- When do you need a flight?  
As soon as possible.
- When will you be back?  
In two hours.

## Answers to practice pages

---

### Unit 1, page 7

- |                  |                    |                    |                |
|------------------|--------------------|--------------------|----------------|
| 1. father        | 2. daughter        | 3. brother         | 4. grandmother |
| 5. sister-in-law | 6. father          | 7. daughter-in-law | 8. brother     |
| 9. daughter      | 10. cousin         | 11. uncle          | 12. aunt       |
| 13. sister       | 14. cousin         | 15. grandfather    | 16. nephew     |
| 17. niece        | 18. brother-in-law |                    |                |

---

### Unit 7, page 66

4. Mom says I can't go out, because it's raining.
5. Mom says I have to tidy my bedroom, so I can't go to the park.
6. We have to go now, because it's after ten o'clock.

---

### Unit 8, page 70

The flight starts at eleven o'clock and finishes at seven o'clock.

---

### Unit 9, page 79

12. Behind the sofa.      13. In front of his house.      14. Beside the TV.      15. Under the bed.  
16. On the table.

---

### Unit 9, page 80

7. He will lift it.      8. He won't lift it.      9. He might lift it.

---

### Unit 9, page 81

4. Yes.      5. No.      6. Maybe.

---

### Unit 11, page 102

On the bed.      On the chair.      On the table.      In the wardrobe.      On the dresser.

---

### Unit 14, page 123

4. Would you lend me your scarf, please?      5. I'd like to borrow \$80,000, please.  
8. He said he doesn't have enough money to buy a car, so will have to rent one.

---

### Unit 16, page 146

- 4.1. I've got two cars.      4.2. One of them is new.      4.3. The other one is old.

---

### Unit 19, page 172

1. I wish I was rich.      2. I wish I had a big house.      3. I wish I played the violin well.

---

### Unit 19, page 177

12. Goodbye.

## Grammar/Function/Topic in Volumes 1 and 2

Ability . . . . . 2.18	Distance . . . . . 2.14	Modals of possibility . . . . . 2.9	Public transport . . . . . 1.19, 2.7
Accommodation . . . . . 2.3	Duration . . . . . 1.8, 2.8	Money . . . . . 1.8	Quantifiers . . . . . 1.19
Activities . . . . . 1.16	Either . . . . . 2.11	Movement . . . . . 2.9	Quantity/division . . . . . 2.3
Address . . . . . 1.12	Electronic appliances . . . . . 2.6	Musical instruments . . . . . 1.13	Question tags . . . . . 1.4
Adjectives . . . . . 1.4	Emotions . . . . . 1.18	Name . . . . . 1.1	Questions . . . . . 2.8
Adjectives (present and past participles) . . . . . 2.2	Enough/too much . . . . . 2.3	Necessity . . . . . 1.13	Recommendations . . . . . 2.13
Adverbs of frequency . . . . . 2.2, 2.18	Events . . . . . 1.2	Negation . . . . . 1.1	Reflexive pronouns . . . . . 2.11
Agreeing and disagreeing . 1.9	Every . . . . . 2.17	Negative adjectives . . . . . 2.12	Renting . . . . . 2.14
Ailments . . . . . 1.11	Family relationships . . 1.1, 2.1	Nouns . . . . . 1.6	Repairs . . . . . 2.12
Animals . . . . . 2.8	Farewells . . . . . 1.11, 2.19	Numbers (grammar of) . 2.14	Reported speech . . . . . 2.2
Applications (employment) . . . . . 2.19	Feelings . . . . . 2.2	Numbers 1 – 10 . . . . . 1.6	Reporting events . . . . . 2.2
Appointments . . . . . 1.18	Few . . . . . 2.13	Numbers 11 – 20 . . . . . 1.8	Rooms . . . . . 1.13
Because/so . . . . . 2.7	Financial transactions . . 2.14	Numbers over 20 . . . . . 1.12	Saying goodbye . . . . . 2.19
Before/after . . . . . 1.17	First conditional . . . . . 2.6	Obligation . . . . . 1.11	Second conditional . . . . . 2.18
Buying goods and services . . . . . 1.13, 2.14	Food and drink . 1.6, 1.9, 2.17	Occupations . . . . . 1.3, 1.7	Shopping . . . . . 2.16
Causatives . . . . . 2.12	Furniture . . . . . 2.11	Offers . . . . . 1.6, 2.6	Simple past . . . . . 1.7, 1.16
Celebrations . . . . . 2.19	Future with will . . . . . 1.12	One/some/all . . . . . 2.1	Simple present . . . . . 1.1
Checking details . . . . . 2.2	Gerunds . . . . . 1.17	Open questions . . . . . 1.6, 1.14	Size . . . . . 2.14, 2.16
Clarification . . . . . 1.7, 2.7	Giving advice . . . . . 2.12	Opinions . . . . . 1.9	Social relationships . . . . . 1.3
Clothes . . . . . 2.11	Greetings . . . . . 1.11	Ordering in restaurants . 2.17	Some/any . . . . . 1.13
Colors . . . . . 1.14	Health . . . . . 1.11, 1.13	Ordinal numbers . . . . . 1.14	Speculating . . . . . 2.11
Communicating with friends . . . . . 2.1	Hopes and wishes . 2.6, 2.19	Paired verbs . . . . . 2.1, 2.7	Superlatives . . . . . 1.9
Comparatives . . 1.9, 2.7, 2.16	Imperatives . . . . . 1.2, 2.1	Parts of the body . . 1.11, 2.13	Symptoms . . . . . 2.13
Comparatives + than . . 2.12	Indefinite article . . . . . 1.6	Past continuous . . . . . 1.17	Telephone language . . . 1.17
Congratulations . . . . . 2.19	In case . . . . . 2.11	Permissions . . . . . 1.19	Television programs . . . . 2.6
Containers . . . . . 1.13	Injuries . . . . . 2.12	Personal pronouns . . . . . 1.2	There is/are . . . . . 2.3
Conversations . . . . . 1.4	Insurance . . . . . 2.14	Places . . . . . 1.2	Third conditional . . . . . 2.18
Correspondence . . . . . 2.1	Interrupted past . . . . . 2.13	Position . . . . . 2.9	Time . . . . . 1.18
Count/uncount nouns . . . 1.6	Introductions . . . . . 1.3	Possessive adjectives . . . 1.1	Time measurement . . . . . 1.19
Damage . . . . . 2.11	Invitations . . . . . 1.2	Possessive pronouns . . . 1.4	Timetable future . . . . . 1.18
Days and months . . . . . 1.8	Irregular verbs . . . . . 1.16	Possibility . . . . . 2.9	Timetables and deadlines . . . . . 2.2
Definite article . . . . . 2.1	Justifying . . . . . 2.11	Preferences . . . . . 2.6	Transport . . . . . 1.8, 1.19
Degrees . . . . . 2.9	Location . . . . . 1.12, 2.9	Prepositions . . . . . 2.1	Travel . . . . . 1.8, 2.7
Demonstratives . . . . . 1.3	Locators . . . . . 1.12	Prepositions . . . . . 2.3, 2.9	Treatments . . . . . 2.13
Describing time . . . . . 2.2	Make-up . . . . . 2.7	Prepositions . . . . . 1.12, 1.14	Until . . . . . 2.13, 2.17
Dining in restaurants . . . 2.17	Making plans . . . . . 2.4	Present continuous . 1.2, 1.16	Verbs . . . . . 1.4
Directions . . . . . 1.14	Mathematics (simple) . . 2.14	Present continuous with future meaning . . . . . 2.4	Weather . . . . . 2.6
	Measurement . . . . . 2.14	Present perfect . . . . . 1.8, 2.4	Wh- questions . . . . . 2.8
	Medical problems . . . . . 2.13	Price . . . . . 1.8, 2.16	You'd better . . . . . 2.12
	Memory . . . . . 2.7	Processes . . . . . 1.16	Zero conditional . . . . . 2.18
	Modals of deduction . . . 2.11	Prohibition . . . . . 1.19	
	Modals of obligation . . . 2.13		

## Index for Volumes 1 and 2

a . . . . . 1.1	afternoon . . . . . 1.11	am . . . . . 1.2	apply . . . . . 2.19
a pair of ... . . . . 1.6	again . . . . . 2.2	angry . . . . . 1.18	appointment . . . . . 1.18
a.m. . . . . 1.18	agree . . . . . 1.9	anniversary . . . . . 2.4	April . . . . . 1.8
accept . . . . . 2.19	airmail . . . . . 2.1	another . . . . . 2.3	are . . . . . 1.2
accident . . . . . 2.2	airport . . . . . 2.1	antelope . . . . . 2.8	Are you all right? . . . . . 1.11
accountant . . . . . 1.3	all . . . . . 2.1	any . . . . . 1.13	aren't . . . . . 1.11
address . . . . . 1.12	almost . . . . . 2.3	anything else . . . . . 2.16	arm . . . . . 1.11
advertisement . . . . . 2.6	alone . . . . . 2.6	apple . . . . . 1.6	around . . . . . 2.4
after . . . . . 1.17	always . . . . . 2.2	application form . . . . . 1.7	around the corner . . . . . 1.12

arrive	1.8	broccoli	1.9	clock	1.18	doesn't work	2.11
arrive at	2.1	brother	1.1	close (adj)	2.9	dollar	1.8
art gallery	1.2	brother-in-law	2.1	close (v)	1.16	don't	1.4
as ... as	2.18	brown	1.14	cloudy	2.6	done up	2.12
as soon as possible	2.19	bruised	2.13	coat	2.11	door	1.2
ask	1.17	bunch	2.17	coffee	1.6	double bed	2.3
at	1.12	burger	1.6	cold	1.4	downstairs	2.3
attendant	2.7	burnt	2.11	colleague	1.3	dress (n)	2.11
August	1.8	bus	1.8	comb	2.7	dress (vb)	2.11
aunt	2.1	bus stop	1.14	come	1.2	dresser	2.11
baby	1.4	businessman	1.7	come back	2.7	drill	2.14
back (n)	1.11	busy	1.17	comedy	2.6	drink	1.17
back (adj)	2.3	but	1.2	comfortable	2.12	drive	1.16
backache	1.11	butter the toast	2.1	computer	2.6	driver's licence	2.14
backyard	2.3	buy	1.16	concert	1.2	drugstore	1.13
bad	1.9	by	1.8	congratulations	2.19	DVD	2.6
bad luck	2.19	Bye.	1.11	cookie	1.6	each	2.3
bag	1.6	cabbage	1.9	corner	1.12	ear	1.11
balcony	2.3	cake	1.6	cough	2.13	earache	1.11
banana	1.6	call	1.12	Could you repeat that		early	1.18
band aid	2.13	camera	1.1	please?	1.7	eat	1.16
bandage	2.13	can	1.2	cousin	2.1	egg	1.13
bank	1.14	Can I help you?	1.9	cow	2.17	eight	1.6
basketball player	1.9	can of ...	1.6	crawl	2.9	eighteen	1.8
bathroom	2.3	Can you tell me the time		creased	2.11	eighth	1.14
battery	2.14	please?	1.18	credit card	1.13	eighty	1.12
beach	1.2	Can you tell me when to		crutches	2.13	either	2.11
beans	1.9	get off?	1.19	cucumber	1.9	elephant	2.8
beautiful	1.4	can't	2.18	cup of ...	1.6	eleven	1.8
because	2.7	cap	1.9	cut	2.13	email	2.1
bedroom	2.3	car	1.1	cute	1.4	empty	1.17
beef	2.17	car park	1.14	Dad	1.11	enough	2.3
beep	1.17	card	1.12	damage	2.14	enter	1.2
before	1.14, 1.17	careful	2.13	danger	2.13	entrée	2.17
behind	2.9	careless	2.13	daughter	1.1	entry	2.7
bell	2.2	carrot	1.9	daughter-in-law	2.1	envelope	2.1
bench	2.12	carton	1.13	day	1.4, 1.8, 1.11	equal	2.3
beside	2.9	cash	1.13	December	1.8	evening	1.11
big	1.9	cat	2.1	delicious	2.17	every	2.2
bill	1.11	cauliflower	1.9	dentist	2.12	everyone	1.8
bird	2.3	caution	2.13	depart from	2.1	everything	2.17
birthday	2.4	ceiling	1.13	deposit	2.14	everywhere	2.17
bite	2.13	celebrate	2.19	dessert	2.17	excellent	2.4
black	1.14	cent	1.8	did	1.7	exchange	2.14
block	2.4	centimeter	2.14	dining room	2.3	excited	2.2
blue	1.14	chair	2.1	dinner	1.2, 1.17	exciting	2.2
book	1.1	change (vb)	2.19	dirty	1.16	Excuse me.	1.1
bored	2.2	change (n)	1.19	disappointed	2.6	exercise	2.13
boring	1.9	channel	2.6	discount	2.14	exit	1.2
borrow	2.14	cheap	1.9	dishwasher	2.6	expensive	1.9
bottle of ...	1.6	check (vb)	2.2	distance	2.14	express	2.7
bottom	2.8	cheque	2.14	divided by	2.14	extra	2.8
bottom drawer	2.11	chess	1.17	do	1.4	eye	2.13
bowl	2.17	chest	2.13	do the dishes	2.6	eyelash	2.7
box	1.13	chest of drawers	2.11	Do you have ...?	1.13	face	2.7
boxer	2.9	child	1.6	Do you like ...?	1.9	fall	2.11
bra	2.11	chips	1.6	Do you take ...?	1.13	family	1.1
branch	2.8	chocolate bar	2.4	doctor	1.7	far	2.9
bread	1.9	cinema	1.14	does	1.4	fast	1.4
breakfast	1.17	clean	1.16	Does this bus go to?	1.19	father	1.1
bring	1.2	clear the table	2.1	doesn't	1.4	fax	2.1

February	1.8	Good night.	1.11	I live at ...	1.12	lay the table	2.1
fence	1.14	Good to meet you.	1.3	ice	2.8	leaf	2.8
few	2.13	grandfather	2.1	I'd like ...	1.3	leave	1.8
fifteen	1.8	grandmother	2.1	I'd like you to meet	1.3	leave a message	1.17
fifth	1.14	great	1.4	I'd love to.	1.2	left	1.14
fifty	1.12	green	11.4	I'd love to but I can't.	1.2	leg	1.11
fight	2.9	guitar	1.13	I'd rather	2.6	lend	2.14
fill out a form	2.14	hair	1.17	I'll	1.12	length	2.14
fine	2.6	half	1.18	I'll get it	1.17	let's	1.2
finger	2.13	half price	2.16	I'm a ...	1.7	letter	2.1
finish	2.8	hamburger	2.3	I'm afraid	2.14	letterbox	2.1
first	1.14	hammer	2.14	I'm afraid I can't.	1.2	lettuce	1.9
fish	2.6	hand	1.11	I'm from...	1.8	lie	2.9
fit	1.4	handbag	2.14	I'm sorry.	1.7	light (n)	2.6
five	1.6	happy	1.18	I'm sorry to hear that.	1.11	light (adj)	1.9
flight	1.18	hat	2.11	I've been here for ...	1.8	like	1.9
floor	1.13	have	1.7	ice cream	1.9	limit	2.14
fly	2.9	have a haircut	1.17	immediately	2.19	lion	2.8
foggy	2.6	Have a nice day.	1.11	in	1.2	lipstick	2.7
foot	1.11	have it .....ed	2.12	in case	2.11	living room	2.3
football	1.17	have to	1.11	in front of	2.9	load the dishwasher	2.1
for	1.8	Have you met ...?	1.3	include	2.14	long	1.17
for sale	2.14	he	1.2	instead	2.6	look forward to	2.1
forget	2.7	head	1.11	insurance (company)	2.14	looks good	1.4
form	2.14	headache	1.11	interested	2.2	looks like	1.3
forty	1.12	heat	1.19	interesting	1.9	lost property	2.7
four	1.6	heavy	1.9	interview	2.19	lottery	2.19
fourteen	1.8	height	2.14	into	2.3	loud	2.6
fourth	1.14	hello	1.7	invitation	2.1	lovely	1.4
Friday	1.8	her	1.1	is	1.1	luggage	2.7
friend	1.3	here	1.3	isn't	1.1	lunch	1.2, 1.17
frightened	2.2	Here you are.	1.19	it	1.1	main course	2.17
frightening	2.2	herself	2.11	it's	1.1	make	1.13
from	1.7	Hi	1.3	It's all right.	1.4	make the toast	2.1
front	2.3	high	2.14	itchy	2.13	March	1.8
full	1.17	hill	2.8	jacket	2.11	mark	2.11
fur	2.8	him	1.2	January	1.8	market	1.2
further	2.9	himself	2.11	jeans	2.11	mascara	2.7
garage	2.3	his	1.1	job advertisement	2.19	May	1.8
garden	1.17	hole	2.11	jockey	1.9	maybe	2.9
garden tools	2.3	holiday	2.1	join	2.8	me	1.2
gas station	1.14	hope	2.6	juice	1.6	mechanic	1.7
gate	2.3	horse	1.9	July	1.8	medicine	2.13
get	1.12	hospital	1.12	jumper	2.11	meet	1.3
get a letter	2.1	hot	2.6	June	1.8	meeting	1.2
get off	1.19	hotel lobby	2.9	just a moment	2.19	menu	2.17
get on	1.19	hour	1.19	just right	2.16	mess	2.3
giraffe	2.8	house	1.1	kangaroo	2.8	message	1.17
glad	2.2	how about ...?	1.2	Keep right.	1.11	met	1.3
glass of ...	1.6	How long ...?	1.19	kettle	2.6	meter	2.14
go	1.2	How many?	1.6	key	1.1	might	2.9
go away	2.7	How much?	1.8	kilometer	2.14	milk	1.6
go home	1.11	how	2.8	kiosk	2.7	mine	1.4
go out	2.19	How's your ... now?	1.13	kitchen	2.3	minus	2.14
golf	1.17	hungry	2.17	knee	1.11	minute	1.19
good	1.4, 9	hurry	2.12	know	1.2	mirror	2.14
Good afternoon.	1.11	hurry up	2.1	koala	2.8	miss	1.19
Good evening.	1.11	hurt	1.11	lamb	2.17	mobile phone	1.1
good idea	2.12	husband	1.1	land	2.1	Mom	1.16
good luck	2.19	I	1.2	laptop	1.1	Monday	1.8
Good morning.	1.11	I don't know.	1.1	late	1.18	money	2.3

month	1.8	open (v)	1.16	price	2.16	September	1.8
moon	1.11	open (adj)	2.9	printer	2.6	serve	2.17
morning	1.11	operation	2.8	probably	2.9	service	2.17
mother	1.1	opposite	1.12	pull	1.16	seven	1.6
motorbike	2.12	or	1.13	purse	1.1	seventeen	1.8
mouth	2.13	orange	1.6, 1.14	push	1.16	seventh	1.14
move	2.12	order	2.17	put	2.1	seventy	1.12
movie	2.6	other	2.16	put on	2.13	share (with)	2.3
multiplied by	2.14	our	1.1	quarter	1.18	she	1.2
mushroom	1.9	ourselves	2.11	quickly	2.1	shed	2.3
must be	2.11	out	1.2	race	2.9	sheep	2.17
my	1.1	out of	2.3	radio	2.6	shirt	2.11
My name's...	1.1	over	2.9	railway station	1.14	shoe	1.4
myself	2.11	over there	2.16	rain	2.6	shop	1.17
name	1.1	p.m.	1.18	rarely	2.18	short	1.9, 1.17
narrow	1.9	pack	2.12	rash	2.13	shoulder	1.11
near	1.12	page	2.1	read	1.17	show	2.13
need	1.13	pair of	2.16	ready	2.7	showers	2.6
neighbor	1.3	pair of sunglasses	1.9	receptionist	1.7	sign	2.14
neither	2.17	panel beater	2.14	recommend	2.17	signature	2.14
nephew	2.1	pants	1.9	red	1.14	since	1.8
never	2.2	parcel	2.1	refund	2.14	single	2.7
new	1.13	park	1.19	registration number	2.14	single bed	2.3
news	2.6	party	1.2	remember	2.7	sister	1.1
newsagent	2.7	pass the milk	2.1	remote control	2.6	sister-in-law	2.1
newspaper	1.17	past	1.14	rent	2.14	sit	1.4
next door	1.12	pasta	1.9	report	2.19	six	1.6
next to	1.12	path	2.3	rest	2.13	sixteen	1.8
niece	2.1	pay	1.11	restaurant	1.2	sixth	1.14
night	1.11	peach	1.6	return	2.7	sixty	1.12
nine	1.6	pear	1.6	rice	1.9	size	2.16
nineteen	1.8	peas	1.9	right (not wrong)	2.2	skirt	2.11
ninety	1.12	pen	1.1	right (not left)	1.14	sleep	1.16
ninth	1.14	percent	2.14	ring (the bell)	2.2	slowly	1.7
no	1.1	pharmacist	1.7	road	1.12	small	1.9
No parking.	1.19	phone	1.17	roof	1.14	snow	2.6
No problem.	1.13	pianist	2.19	room	1.13	so	2.7
No, I haven't.	1.3	piano	1.13	room service	2.9	sock	1.6
No, thanks.	1.6	picnic	1.2	run	1.4	sofa	2.1
nose	2.13	piece of ...	1.6	sad	1.18	soft	2.6
not	1.4	pig	2.17	safe	2.12	some	1.6
not ... enough	2.9	plane	1.4	sale	2.16	something to drink	1.6
not enough	2.3	plane crash	2.6	sales assistant	1.7	something to eat	1.6
November	1.8	plate	2.17	same	2.16	sometimes	2.2
now	1.7	platform	2.7	sandwich	1.6	somewhere	2.4
number	1.17	play	1.4, 1.13	Saturday	1.8	son	1.1
nurse	1.7	please	1.17	sauce	2.3	son-in-law	2.1
nuts	1.6	plum	1.6	sausage	1.6	soon	2.13
o'clock	1.18	plus	2.14	saw (n)	2.14	Sorry.	1.11
occupation	1.7	point	2.14	say	2.2	Sorry, I can't.	1.2
October	1.8	police officer	1.7	scarf	2.14	soup	2.17
off	2.1	police station	1.12	school	1.8	speak	1.17
often	2.18	pork	2.17	scratch	2.13	special	2.16
OK	1.2	possibly	2.9	seal	2.8	sport	2.6
old	1.13	post office	1.14	seat	1.4	stadium	1.14
on	1.12, 2.1, 2.9	postcard	2.1	second	1.14, 1.19	stamp	2.1
on time	2.2	postman	2.1	secretary	1.3	stand	2.9
once	2.2	potato	2.17	See you later.	1.11	stars	1.11
one	1.6	pouch	2.8	sell	1.16	start	2.8
one hundred	1.12	powder	2.7	send a letter	2.1	stay in bed	2.13
onion	1.9	prescription	2.13	separate	2.8	still	1.8

stockings	2.11	third	1.14	twice	2.2	What's wrong?	1.11
stomach	1.11	thirsty	2.17	twin	2.7	What's your address?	1.12
stomachache	1.11	thirteen	1.8	two	1.6	What's your name?	1.1
stop	1.11	thirty	1.12	two hundred and one	1.12	wheel	2.14
stop smoking	2.13	thirty-one	1.12	umbrella	2.7	when	1.7
storm	2.6	this	1.1	uncle	2.1	where	1.7
straight ahead	1.14	this is...	1.1	uncomfortable	2.12	Where are you from?	1.8
street	1.12	those	1.3	under	2.9	Where do you live?	1.12
student	2.2	three	1.6	undone	2.12	which	2.7
sugar	1.6	three times	2.2	unequal	2.3	while	2.4
suit	2.11	through	2.3	unhappy	2.12	white	1.14
suitcase	1.9	thumb	2.13	unlimited	2.14	who	1.2
sun	1.11	Thursday	1.8	unpack	2.12	Who's calling?	1.17
Sunday	1.8	ticket	1.6	unsafe	2.12	whose	1.1
sunny	2.6	ticket office	2.7	until	2.13	why	2.8
supermarket	1.14	tidy (up)	2.3	upstairs	2.3	wide	1.9
sure	1.2	tie	2.11	us	1.2	width	2.14
surfboard	1.9	tiger	2.8	use	1.19	wife	1.1
surprised	2.2	timetable	1.19	vegetable	2.17	will	1.12
surprising	2.2	tired	2.2	vending machine	2.9	window	1.13
swim	1.17	tiring	2.2	very	1.9	windsurfer	2.14
switch	2.6	to	1.2, 1.7	very much	1.9	windy	2.6
swollen	2.13	to... ?	1.19	via	2.7	wish	2.19
tablet	1.6	today	1.18	view	1.4	with	1.14
take	2.8	together	2.6	violin	1.13	without	2.3
take a message	1.17	toilet	1.14	violinist	2.19	work	1.4, 1.17
take off	2.1	tomato	1.9	visit	2.6	world	2.4
talk	1.16	tomorrow	1.18	volume control	2.6	worried	1.18
tall	1.9	tongue	2.13	vomit	2.13	Would you like...?	1.6
tandem	2.3	too	1.7	wait	1.13	Would you like to come	
taxi driver	1.7	too much	2.3	waiting room	1.13	to ...?	1.2
taxi rank	1.14	tooth	1.11	walk	2.9	write	1.16
tea	1.6	toothache	1.11	wall	1.13	write a letter	2.1
teach	1.16	toothbrush	1.13	wallet	1.1	wrong	2.2
teacher	1.3	toothpaste	1.13	want	2.1	x-ray	2.12
team	2.19	top	2.8	wardrobe	2.9	year	1.8
telephone	1.17	top drawer	2.11	was	1.7, 1.16	yellow	1.14
television	1.17	torn	2.11	wash	1.16	yes	1.1
tell	2.2	tour	2.8	watch (n)	1.1	Yes, please.	1.6
temperature	2.6	tour guide	1.7	watch (v)	1.17	yesterday	1.18
ten	1.6	traffic lights	1.14	water	1.6	you	1.2
tennis	1.17	train	1.8	we	1.2	You should ...	1.13
tenth	11.4	tree	2.8	wear	2.11	you'd better	2.12
terrible	2.17	trophy	2.2	weather forecast	2.6	You're not allowed to ...	1.9
Thank you.	1.1	trousers	2.11	weather report	2.6	your	1.1
Thanks for coming.	1.11	truck	2.12	wedding	1.18	yours	1.4
that	1.3	trumpet	1.13	Wednesday	1.8	yours sincerely	2.1
That'd be great.	1.2	trunk	2.8	week	1.8	yourself	2.11
That's OK	1.13	try on	2.16	weekend	1.8	yourselves	2.11
the	1.1	T-shirt	2.11	welcome	1.18	zebra	2.8
theater	1.2	tube	1.13	well	1.4	zoo	2.4
their	1.1	Tuesday	1.8	well done	2.19		
them	1.2	tunnel	2.3	were	1.3, 1.16		
themselves	2.11	turn	1.14	wet	1.4		
there	1.3	turn down	2.6	what	1.1		
there are	2.3	turn off	2.6	What do you do?	1.7		
there is	2.3	turn on	2.6	What do you think?	1.9		
thermometer	2.6	turn up	2.6	What would you like?	1.6		
these	1.3	twelve	1.8	what	2.8		
they	1.2	twenty	1.8	What's the matter?	1.11		
think	1.9	twenty-one	1.12	What's the time?	1.18		

**English Made Easy** is a breakthrough in English language learning—imaginatively exploiting how pictures and text can work together to create understanding and help learners learn more productively. It gives learners easy access to the vocabulary, grammar and functions of English as it is actually used in a comprehensive range of social situations. Self-guided students and classroom learners alike will be delighted by the way they are helped to progress easily from one unit to the next, using a combination of pictures and text to discover for themselves how English works. The pictorial method used in this book is based on a thorough understanding of language structure and how language is successfully learned. The authors are experienced English language teachers with strong backgrounds in language analysis and language learning.

**English Made Easy: Learning English through Pictures Volume 2** consists of a total of 20 units arranged in groups of five. The first four units present language and provide learners opportunities to practice as they learn. The first page of each unit has a list of all the words and phrases to be learned in that unit. At the end of each unit, an interesting story which uses the language that has just been learned is presented. The fifth unit in each group contains exercises designed to reinforce the language learned in the first four units.

**TUTTLE**

[www.tuttlepublishing.com](http://www.tuttlepublishing.com)

Printed in Singapore

ISBN 978-1-4629-0969-8  
5 1 9 9 5  
9 781462 909698 US \$19.95